



ALLEN-BRADLEY

1771 I/O Chassis and Power Supplies

Product Data

Features/Benefits

System and Auxiliary Power Supplies

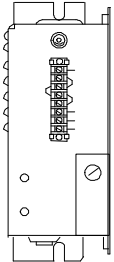

- various output current ranges — purchase a power supply to fit your needs
- mounted alongside an I/O chassis — no I/O chassis slots required
- battery backup (where specified) — supplies memory backup power if the power supply shuts down due to loss of ac power

- provides four slots for mounting:
 - 1771 power-supply modules
 - three communication modules and one power-supply module
- mounts separately or directly to Universal I/O chassis
- removable 1771 wiring arms — service modules without rewiring I/O devices

Power-supply Modules

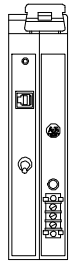

- provide 5V dc power directly to the I/O chassis backplane
- occupy slots in your I/O chassis - require no space outside the chassis and connect directly to backplane
- can provide up to 24 amps per chassis
- single failure-proof chassis power using redundant configurations

I/O Chassis with Integral Power Supply and Adapter

- power supply and adapter included — use a minimal amount of panel space
- provides one or two slots for 1771 I/O modules
- quick-connect, removable connectors for ac power and communication cable connections
- built-in power switch and fuse
- diagnostic indicators for maintenance and troubleshooting

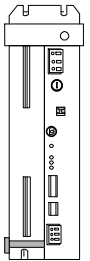

Power-supply Chassis

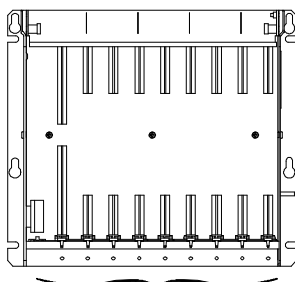

4, 8, 12 or 16 slots

Universal I/O Chassis

- available in 4, 8, 12 or 16-slot versions
- accepts all 1771 I/O compatible modules
- removable 1771 wiring arms — service modules without rewiring I/O devices

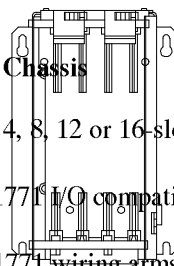

For information on	See page
system and auxiliary power supplies	4
power-supply modules	5
power-supply chassis	7

I/O chassis with integral power supply and adapter	8
universal I/O chassis	9
power requirements and transformer sizing	12

System and Auxiliary Power Supplies

1771 system and auxiliary power supplies provide 5V dc to power 1771 Universal I/O chassis for installed processors and I/O modules. These power supplies fill a variety of application requirements by operating on 120/220V ac.

System and auxiliary power supplies are mounted on the side plate of a 1771 I/O chassis or up to five cable-feet from the I/O chassis.

Specifications

	1771-P1	1771-P2	1771-P7	1771-PS7
Nominal Input Voltage	120V ac @ 0.75A 220/240V ac @ 0.38A	120V ac @ 0.75A 220/240V ac @ 0.38A	120V ac @ 2.0A 220V ac @ 1.0A	120V ac @ 2.0A 220V ac @ 1.0A
Input Voltage Range	120V: 98–132V ac 220V: 196–250 ac	120V: 98–132V ac 220V: 196–250 ac	120V: 97–132V ac 220V: 195–264V ac	120V: 97–132V ac 220V: 195–264V ac
Input Power (Real / Apparent)	64W / 87VA	64W / 87VA	108W / 176VA	171W / 257VA
External Transformer	160VA @ full load	160VA @ full load	270VA @ full load	428VA @ full load
Frequency Range	60/50Hz	60/50Hz	47–63Hz	47–63Hz
Isolation	2500V dc for 1s 1800V ac (rms) for 1s	2500V dc for 1s 1800V ac (rms) for 1s	2500V dc for 1s 1800V ac (rms) for 1s	1.5kV ac (rms) input line to all outputs 1.5kV ac (rms) input line to chassis 1.5kV ac (rms) user power to backplane power 707V ac (rms) user power to chassis
Output Voltage	5.1V dc \pm 5% 5.1V dc \pm 5%	5.1V dc \pm 5% 5.1V dc \pm 5%	5.06V dc \pm 3.8%	5.1V dc
Output Current	6.5A @ 5V dc	6.5A @ 5V dc	16A @ 5V dc	16A @ 5V dc
User Output Current and Voltage	N/A	N/A	N/A	8A @ 5V dc 2A @ 15V dc 2A @ –15V dc 2.5A @ 24V dc
Power Loss Time Delay — Input Power Loss to Processor Disable	13.5ms \pm 2.5ms	13.5ms \pm 2.5ms	13.6ms \pm 2.96ms	15ms to 20ms
Replacement Fuses	120V: 1A, 3AG, slow-blow 220V: 0.5A, 3AG, slow-blow	120V: 1A, 3AG, slow-blow 220V: 0.5A, 3AG, slow-blow	3A, 250V, normal-blow	3A, 250V, normal-blow
Weight	5.89kg (13lbs)	5.89kg (13lbs)	1.95kg (4.3lbs)	2.93kg (6.5lbs) – with mounting bracket
Dimensions (W x H x D)	116mm x 285mm x 182mm (4.56 x 11.25 x 7.16")	116mm x 285mm x 182mm (4.56 x 11.25 x 7.16")	115mm x 315mm x 159mm (4.53 x 12.40 x 6.25")	115mm x 315mm x 183mm (4.53 x 12.40 x 7.2")
Environmental Conditions	Operating Temperature Storage Temperature Relative Humidity	0 to 60°C (32 to 140°F) –40 to 85°C (–40 to 185°F) 5 to 95%, noncondensing	0 to 60°C (32 to 140°F) –40 to 85°C (–40 to 185°F) 5 to 95%, noncondensing	0 to 60°C (32 to 140°F) –40 to 85°C (–40 to 185°F) 5 to 95%, noncondensing
Battery Type	2 alkaline D-size 1.5V or 1 lithium D-size 3.4V	N/A	N/A	N/A
Cables	1771-CL – 0.30m (1ft) 1771-CM – 1.52m (5ft) 1771-CL2 – 0.64m (2.08ft), for 1771-A3B	1771-CD – 1.52m (5ft) 1771-CE – 0.30m (1ft)	1771-CP1 – 0.32m (1.04ft) 1771-CP2 – 1.52m (5ft) 1771-CP3 – 1.52m (5ft), right angle	1771-CA3B – 0.30m (1ft) 1771-CAS – 1.2m (4ft) 1771-PSCC – 1.68m (5.5ft)
Location	side plate of 1771 I/O chassis or up to 5 cable-feet from I/O chassis			

Power-supply modules are used in 1771 I/O chassis to provide 5V dc power directly to the chassis backplane. These power supplies occupy one or two slots and can provide up to 8 amps to the I/O chassis. Power-supply modules can be paralleled to provide up to 16 amps per chassis.

You can use redundant power-supply modules to:

- protect your system from a power-supply failure or power-source failure
- provide up to 24 amps per chassis
- provide internal relay with contacts rated at 1A, 250V ac maximum

Redundant Power-supply Modules (1771-P4R, -P6R)

You determine the number of redundant power-supply modules you need based on your application.

Redundant power-supply modules are designed for N+1¹ redundancy:

Where	Is
N	the minimum quantity of redundant power-supply modules needed to power the chassis without redundancy
1	the additional redundant power-supply module that acts as a buffer to be exchanged upon a power supply failure

¹ N+2 and N+3 systems can also be configured; contact your local Allen-Bradley representative for details.



ATTENTION: Because of the compact form factor of the 1771 I/O system, observe these derating guidelines when using a redundant power-supply system (RPS).

For power-source failures, select from these systems		For power-supply failures, select from these systems	
two RPS	no derating, 60°C @ ≤ 8A	two RPS	no derating, 60°C @ ≤ 8A
four RPS	16A maximum up to 55°C derated to 14A maximum @ 60°C	three RPS	16A maximum up to 55°C derated to 14A maximum @ 60°C
		four RPS	24A maximum up to 55°C derated to 20A maximum @ 60°C

If you do not follow the above guidelines, the RPS may encounter unacceptable internal temperatures.

Power-supply Modules**Specifications**

	1771-P4R	1771-P6R	1771-P5, -P5E	1771-P10
Nominal Input Voltage	120V ac	220V ac	24V dc	125V dc
Input Voltage Range	97-132V ac rms	194-264V ac rms	20.5-30V dc ¹	97-145V dc ¹
Input Power (Real / Apparent)	59W / 92VA		57W	72W
External Transformer	148VA @ full load		N/A	N/A
Frequency Range	47-63Hz		dc ¹	dc ¹
Isolation	2500V dc for 1s 1800V rms for 1s		2160V dc for 1s	2160V dc for 1s
Output Voltage (backplane)	5.06V dc \pm 3.8%		5.06V dc \pm 3.8%	5.06V dc \pm 3.8%
Output Current (maximum)	8A (2 unit system) 14A (3 unit system) ² 20A (4 unit system) ³		8A	8A
Power Loss Time Delay — Input Power Loss to Processor Disable	13.6ms \pm 2.96ms		13.6ms \pm 3.6ms or 60ms (jumper selectable 1771-P5E only)	8 to 10ms
Replacement Fuses	1.5A 250V, slow-blow		5A 32V, normal-blow	1.5A 250V, slow-blow
Weight	0.84kg (2lbs)		1.04kg (2.3lbs)	1.17kg (2.6lbs)
Environmental Conditions	Operating Temperature Storage Temperature Relative Humidity	0 to 60°C (32 to 140°F) -40 to 85°C (-40 to 185°F) 5 to 95%, noncondensing	0 to 60°C (32 to 140°F) -40 to 85°C (-40 to 185°F) 5 to 95%, noncondensing	0 to 60°C (32 to 140°F) -40 to 85°C (-40 to 185°F) 5 to 95%, noncondensing
Terminal Block	ac power: A-B PN 941274-05 (Wago PN 231-205/000-008) ⁴ relay: 941274-03 (Wago PN 231-203/000-0080)		strip	strip
Alarm Relay Rating	30W / 1A ⁵ maximum 24V-250V ac or 24V-125V dc		N/A	N/A
Location	one I/O chassis slot		two I/O chassis slots	two I/O chassis slots

¹ Input voltage range includes ripple. Full wave rectified and filtered dc is acceptable if peak-peak ripple is less than 10% of the input voltage.

² 16A @ 55°C (3 unit system).

³ 24A @ 55°C (4 unit system).

⁴ Wago Corporation, 9085 North Deerbrook Trail, Brown Deer, Wisconsin 53223.

⁵ Spikes, peaks and surges must be within the power rating. Resistive loads only. Ac or dc power = 30W maximum.

	1771-P4S	1771-P6S	1771-P4S1	1771-P6S1
Nominal Input Voltage	120V ac	220V ac	100V ac	200V ac
Input Voltage Range	97-132V ac rms	194-264V ac rms	85-120V ac rms	170-240V ac rms
Input Power (Real / Apparent)	56W / 89VA			
External Transformer	140VA @ full load			
Frequency Range	47-63Hz			
Isolation	2500V dc for 1s 1800V rms for 1s			
Output Voltage (backplane)	5.06V dc \pm 3.8%			
Output Current (maximum)	8A @ 5V dc			
Power Loss Time Delay — Input Power Loss to Processor Disable	13.6ms \pm 2.96ms			
Replacement Fuses	1.5A 250V, slow-blow			
Weight	0.84kg (2lbs)			
Environmental Conditions	Operating Temperature Storage Temperature Relative Humidity	0 to 60°C (32 to 140°F) -40 to 85°C (-40 to 185°F) 5 to 95%, noncondensing		
Terminal Block	A-B PN 941274-05 (Wago PN 231-205/000-008) ¹			
Location	one I/O chassis slot			

¹ Wago Corporation, 9085 North Deerbrook Trail, Brown Deer, Wisconsin 53223.

The 1771-PSC power supply chassis provides four slots for mounting modular power supplies to provide up to 24 amps to a 1771 Universal I/O chassis. It can also be used to mount communication modules that need +5V DC power and a processor enable signal. The 1771-PSC may be mounted either directly to a 1771-A1B, -A2B, -A3B1, or -A4B I/O chassis, or mounted separately.

Power Supply Compatibility

You can use the 1771-PSC with		Current Available	Open Slots
1	1771-P3 ¹	3A	3
2	1771-P3 ¹ (in parallel ²)	6A	2
1	1771-P4 ¹	8A	2
1	1771-P4S, -P6S, -P4S1, or -P6S1	8A	3
2	1771-P4R, -P6R (redundant)	8A	2
1	1771-P5, -P5E or -P10	8A	2
1	1771-P4 ¹ (in parallel ²)	each — 1771-P3 ¹ and 1771-P4 ¹	1
1	1771-P4S (in parallel ²)	each — 1771-P3 ¹ and 1771-P4S	2
3	1771-P4R, -P6R (redundant)	14A	1
2	1771-P4 ¹ (in parallel)	16A	0
2	1771-P4S, -P6S, -P4S1, -P6S1 (in parallel ²)	16A	2
1	1771-P4S (in parallel ²)	each — 1771-P4 ¹ and 1771-P4S	1
2	1771-P5, -P5E or -P10 (in parallel ²)	16A	0
4	1771-P4R, -P6R (redundant ³)	20A	0

¹ Superseded by 1771-P4S, -P6S, -P4S1, -P6S1
² Power supplies operated in parallel; use a 1771-CT interconnect cable.
³ Up to 24 amps at 55°C.

Mounting Dimensions

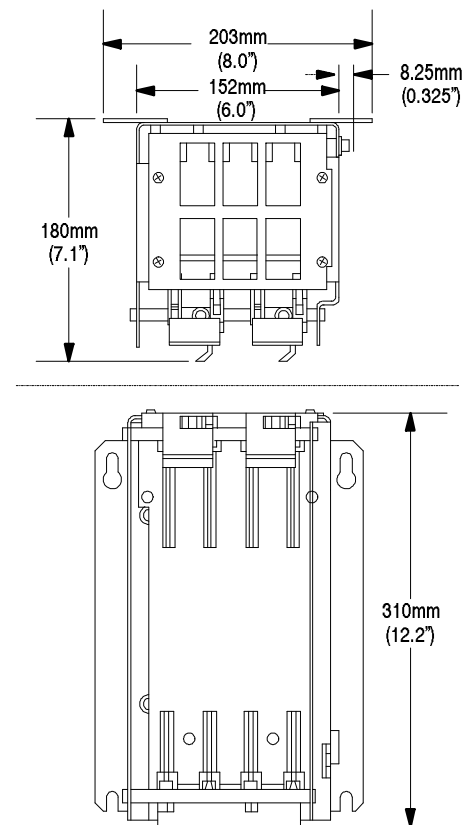

Module Compatibility

The 1771-PSC can provide a mounting location for these modules:

- 1770-RG — PLC-2 Report Generation
- 1771-AF — Fiber Optic Converter
- 1771-DB — Basic Module (in non-block transfer operations)
- 1771-KA2 — Communication Adapter
- 1771-KE — Communication Controller
- 1771-KG — PLC-2 Family/RS-232-C Communication Interface
- 1771-KH — Modem Interface
- 1775-RM — Peripheral Interface Adapter
- 1785-KA — PLC-5 Communication Adapter

Specifications

1771-PSC		
Dimensions (W x H x D)		203 ¹ x 310 x 180mm (8.0 ¹ x 12.2 x 7.1 ¹)
Mounting Holes	horizontal	178mm (7.0 ¹)
	vertical	254mm (10.0 ¹)
Weight flanges	without	1.3kg (2.9lbs)
	with flanges	1.85kg (4.06lbs)
Maximum Backplane Current ²		20A @ 60°C / 24A @ 55°C
Environmental Conditions	Operating Temperature	0 to 60°C (32 to 140°F)
	Storage Temperature	-40 to 85°C (-40 to 185°F)
	Relative Humidity	5 to 95%, noncondensing

¹ Includes flanges, main part of chassis is 152.4mm (6.0¹).
² Maximum backplane current using multiple power supplies.

I/O Chassis with Integral Power Supply and Adapter

The 1771-AM1 and 1771-AM2 are I/O chassis with an integral power supply (user-selectable 110/220V, 50/60Hz ac) and a remote I/O adapter. The 1771-AM1 has one I/O slot for the insertion of any single-slot 1771 I/O module. The 1771-AM2 has two slots for the insertion of two single-slot 1771 I/O modules or one double-slot I/O module.

Specifications

		1771-AM1	1771-AM2
Dimensions (W x H x D)		69.9 x 298.5 x 187.3mm 2.75 x 11.75 x 7.375"	130.2 x 298.5 x 187.3mm 5.125 x 11.75 x 7.375"
Weight		1.35kg (3lbs)	2.27kg (5lbs)
I/O Module Capacity		1 single-slot I/O module	2 single-slot or 1 double-slot I/O module
Conductors	Wire Size Category	14 ga. stranded (maximum); 3/64 inch insulation (maximum) 1 ¹	
Integral Power Supply			
Nominal Input Voltage		120V ac @ 50/60Hz; 220V ac @ 50/60Hz (switch selectable)	
Input Voltage Range		97-132V ac rms; 194-264V ac rms	
Input Power (Real / Apparent)		30W / 48VA	
External Transformer		75VA @ full load	
Frequency Range		47-63Hz	
Isolation		2500V dc for 1s	
Output Voltage		5.1V dc \pm 3.8%	
Output Current		3.5A	
Backplane Current		3A available for I/O Modules	
Power Loss Time Delay		13.6ms \pm 2.96ms	
Replacement Fuse		1.5A 250V, slow-blow	
Environmental Conditions	Operating Temperature Storage Temperature Relative Humidity	0 to 60°C (32 to 140°F) -40 to 85°C (-40 to 185°F) 5 to 95%, noncondensing	
Integral Remote I/O Adapter			
Baud Rate		57.6K; 115.2K bit/s	
Chassis Distance		5,000ft @ 115.2K bit/s; 10,000ft @ 57.6K bit/s	
Removable Wiring Blocks			
Communication Wiring Block		A-B PN 940611-03 (Phoenix Terminal Blocks, Inc., PN 1752179)	
Input Wiring Block		A-B PN 941274-03 (Wago PN 231-203/000-008) ²	

¹ Refer to publication 1770-4.1, *Industrial Automation Wiring and Grounding Guidelines*.

² Wago Corporation, 9085 North Deerbrook Trail, Brown Deer, Wisconsin 53223.

The left-most slot of each chassis accepts either a processor module or an I/O adapter module. The other slots in the chassis accept communication modules, I/O modules and power-supply modules.

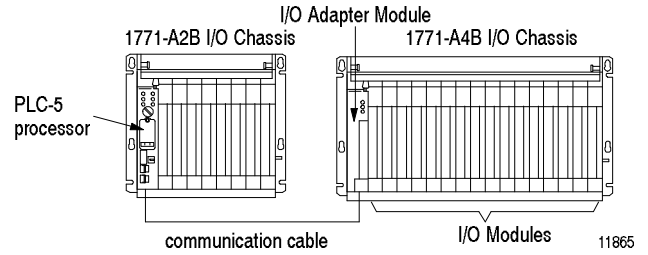

Specifications

I/O Chassis Series B (Cat. No.)	Type of Mount	General Dimensions (W x H x D)	Weight (without modules)	I/O Module Slots	Maximum Backplane Current	Compatible Replacement for Chassis	
						Series A	Supersedes
1771-A1B/B	panel	229 x 315 x 193mm (9.0 x 12.4 x 7.6")	3.6kg (8lbs)	4	16A	1771-A1B	1771-A1
1771-A2B/B	panel	356 x 315 x 193mm (14.0 x 12.4 x 7.6")	4.5kg (10lbs)	8	16A	1771-A2B	1771-A2
1771-A3B/B	panel or 19" rack	483 x 339 x 221mm (19.0 x 13.35 x 8.7")	5.9kg (13lbs)	12	24A	1771-A3B	none
1771-A3B1/B	panel	483 x 315 x 193mm (19.0 x 12.4 x 7.6")	5.9kg (13lbs)	12	24A	1771-A3B1	none
1771-A4B/B	panel	610 x 315 x 193mm (24.0 x 12.4 x 7.6")	7.3kg (16lbs)	16	24A	1771-A4B	1771-A4
	Operating Temperature	Storage Temperature		Relative Humidity		CSA Certification (when product is marked)	
All Chassis	0° to 60°C (32° to 140°F)	-40° to 85°C (-40° to 185°F)		5 to 95% (noncondensing)		Class 1, Division 2, Groups A, B, C and D	

Universal I/O Chassis

Mounting Dimensions

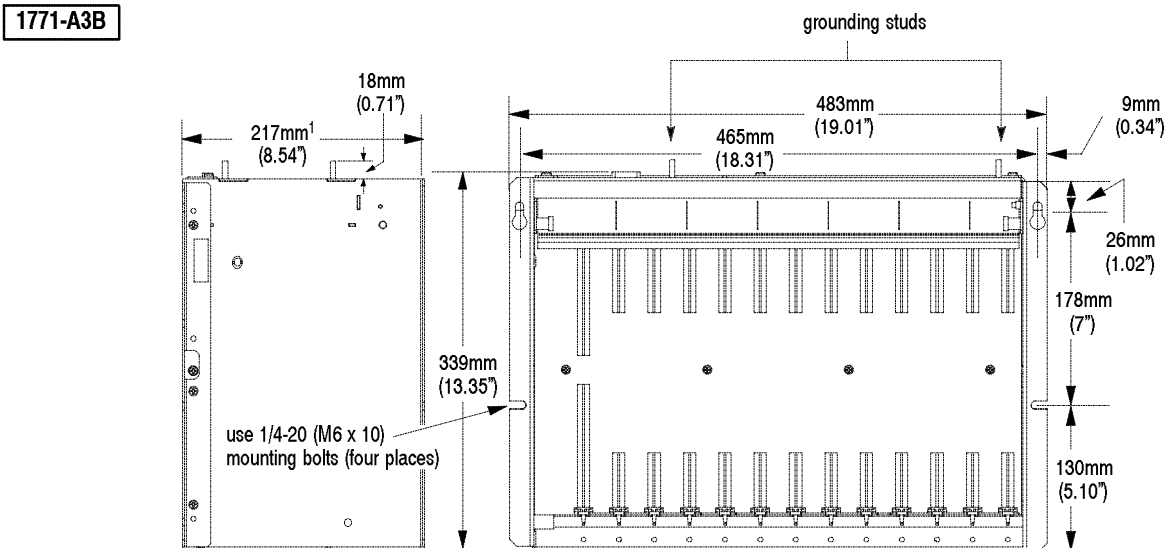
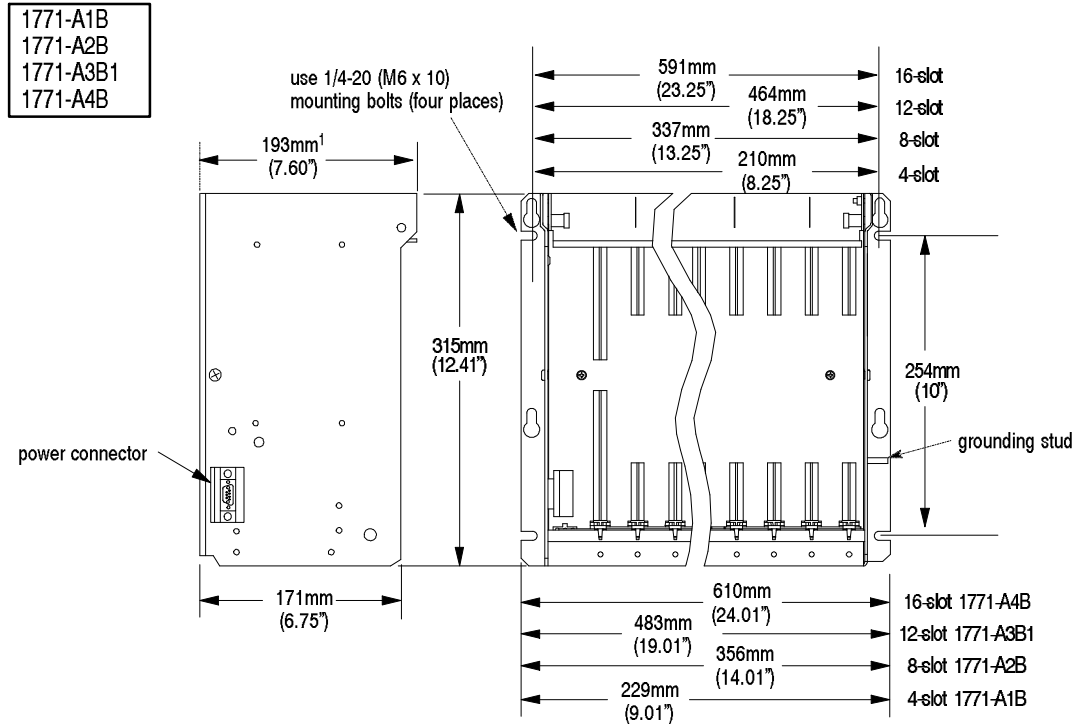

¹ Total maximum depth dimension per installation depends on module wiring and connectors.

Each ac-input power supply generates a shutdown signal on the backplane whenever the ac line voltage drops below its lower voltage limit, and removes the shutdown signal when the line voltage comes back up to the lower voltage limit. This shutdown is necessary to ensure that only valid data is stored in memory.

The external transformer rating (in VA) of each power supply is greater than either its real power dissipation (in Watts) or its apparent power requirements (in VA) because converting ac to dc draws power only from the peak of the ac voltage wave form. If the transformer is too small, it clips the peak of the sine wave; when the voltage is still above the lower voltage limit, the power supply will sense this clipped wave form as low voltage and prematurely shut down the adapter or in-chassis controller processor.

1771-P1, -P2

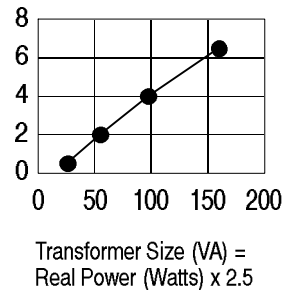
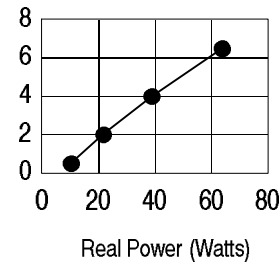
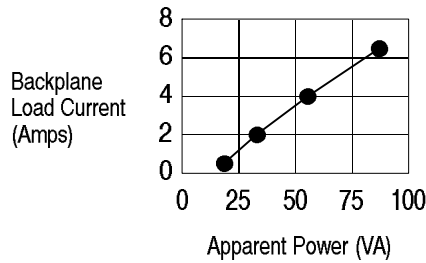

1771-P7

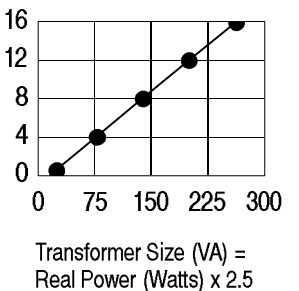
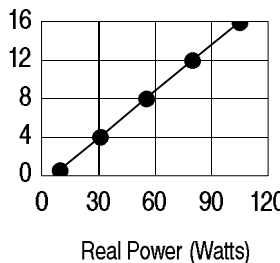
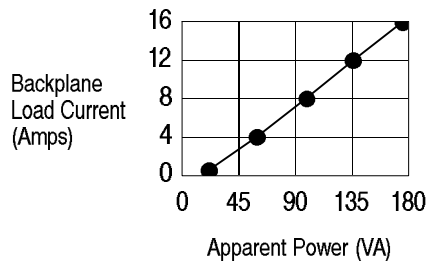

1771-PS7

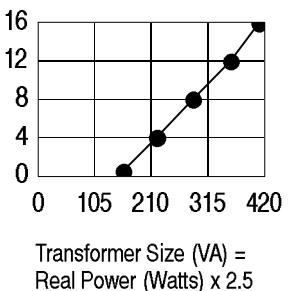
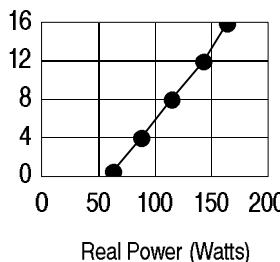
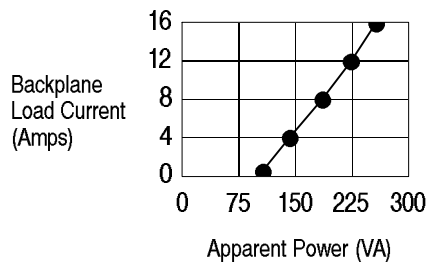

1771-P5, -P5E

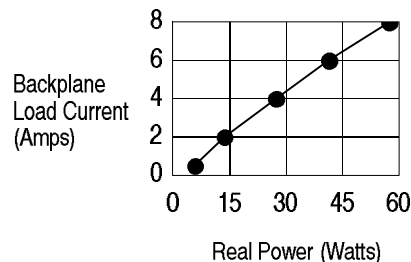

Universal I/O Chassis

1771-P10

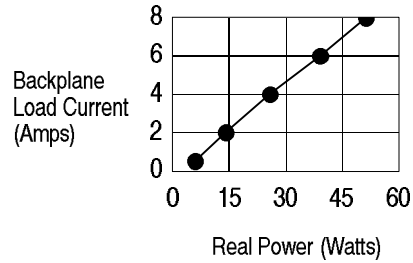

1771-P4R, -P6R

1 unit

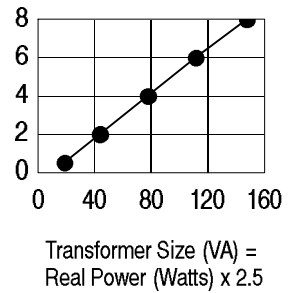
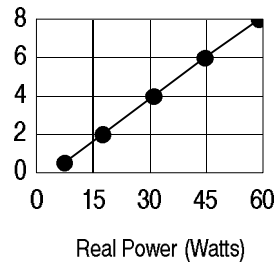
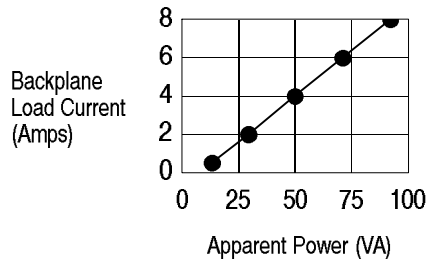

2 units

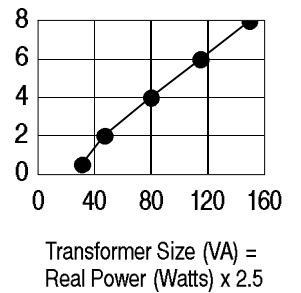
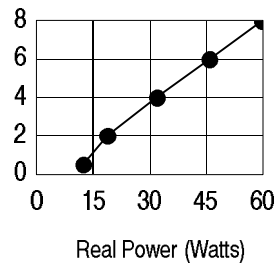
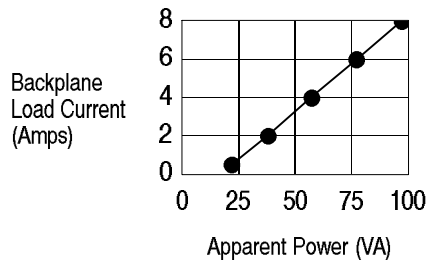

3 units

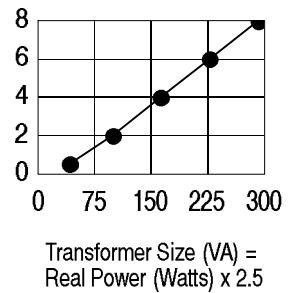
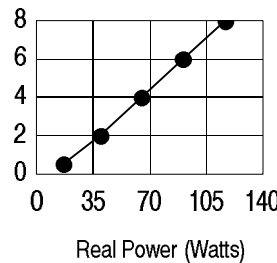
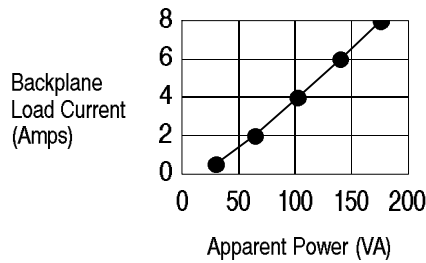

4 units

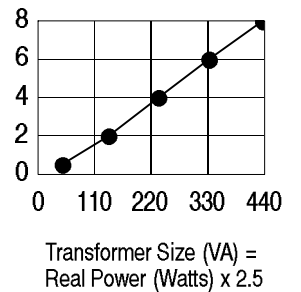
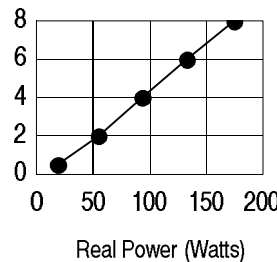
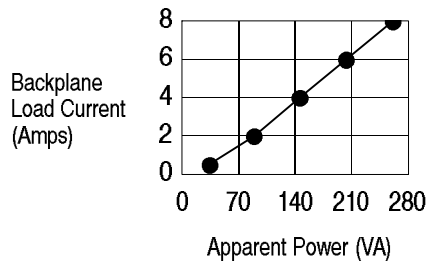

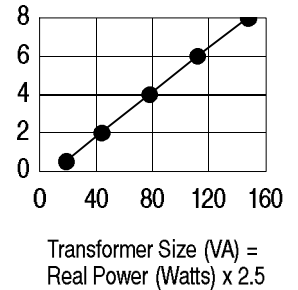
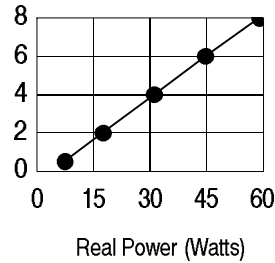
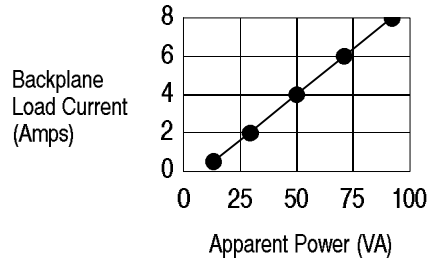
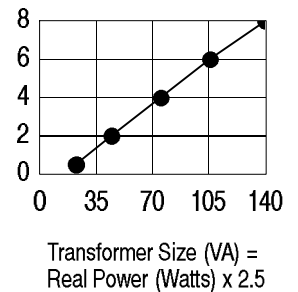
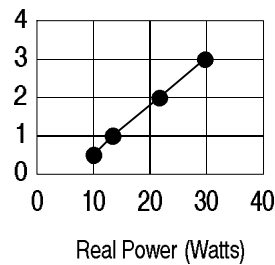
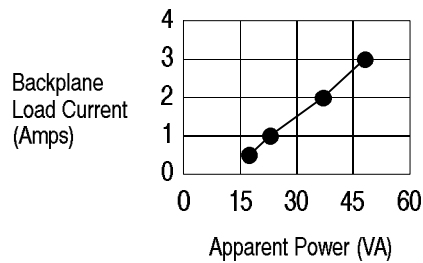
**1771-P4S, -P6S,
-P4S1, -P6S1****1771-AM1, -AM2**

As a subsidiary of Rockwell International, one of the world's largest technology companies — Allen-Bradley meets today's challenges of industrial automation with over 85 years of practical plant-floor experience. More than 11,000 employees throughout the world design, manufacture and apply a wide range of control and automation products and supporting services to help our customers continuously improve quality, productivity and time to market. These products and services not only control individual machines but integrate the manufacturing process, while providing access to vital plant floor data that can be used to support decision-making throughout the enterprise.

With offices in major cities worldwide

WORLD HEADQUARTERS
Allen-Bradley
1201 South Second Street
Milwaukee, WI 53204 USA
Tel: (1) 414 382-2000
Telex: 43 11 016
FAX: (1) 414 382-4444

EUROPE/MIDDLE EAST/AFRICA HEADQUARTERS
Allen-Bradley Europe B.V.
Amsterdamseweg 15
1422 AC Uithoorn
The Netherlands
Tel: (31) 2975/43500
Telex: (844) 18042
FAX: (31) 2975/60222

ASIA/PACIFIC HEADQUARTERS
Allen-Bradley (Hong Kong) Limited
Room 1006, Block B, Sea View Estate
28 Watson Road
Hong Kong
Tel: (852) 887-4788
Telex: (780) 64347
FAX: (852) 510-9436

CANADA HEADQUARTERS
Allen-Bradley Canada Limited
135 Dundas Street
Cambridge, Ontario N1R 5X1
Canada
Tel: (1) 519 623-1810
FAX: (1) 519 623-8930

LATIN AMERICA HEADQUARTERS
Allen-Bradley
1201 South Second Street
Milwaukee, WI 53204 USA
Tel: (1) 414 382-2000
Telex: 43 11 016
FAX: (1) 414 382-2400