



Where Automation Connects.



inRAX[®] MVI56E-MNETC

ControlLogix Platform

Modbus TCP/IP Multi Client

Enhanced Communication Module

April 18, 2011

SETUP GUIDE

Your Feedback Please

We always want you to feel that you made the right decision to use our products. If you have suggestions, comments, compliments or complaints about our products, documentation, or support, please write or call us.

How to Contact Us

ProSoft Technology

5201 Truxtun Ave., 3rd Floor

Bakersfield, CA 93309

+1 (661) 716-5100

+1 (661) 716-5101 (Fax)

www.prosoft-technology.com

support@prosoft-technology.com

Copyright © 2011 ProSoft Technology, Inc., all rights reserved.

MVI56E-MNETC Setup Guide

April 18, 2011

ProSoft Technology[®], ProLinx[®], inRAx[®], ProTalk[®], and RadioLinx[®] are Registered Trademarks of ProSoft Technology, Inc. All other brand or product names are or may be trademarks of, and are used to identify products and services of, their respective owners.

ProSoft Technology[®] Product Documentation

In an effort to conserve paper, ProSoft Technology no longer includes printed manuals with our product shipments. User Manuals, Datasheets, Sample Ladder Files, and Configuration Files are provided on the enclosed CD-ROM, and are available at no charge from our web site: www.prosoft-technology.com

Important Safety Information

North America Warnings

- A** Warning - Explosion Hazard - Substitution of components may impair suitability for Class I, Division 2.
- B** Warning - Explosion Hazard - When in hazardous locations, turn off power before replacing or rewiring modules.
Warning - Explosion Hazard - Do not disconnect equipment unless power has been switched off or the area is known to be nonhazardous.
- C** Suitable for use in Class I, Division 2 Groups A, B, C, and D, T5 Hazardous Locations or Non-Hazardous Locations.

ATEX Warnings and Conditions of Safe Usage

Power, Input, and Output (I/O) wiring must be in accordance with the authority having jurisdiction

- A** Warning - Explosion Hazard - When in hazardous locations, turn off power before replacing or wiring modules.
- B** Warning - Explosion Hazard - Do not disconnect equipment unless power has been switched off or the area is known to be non-hazardous.
- C** These products are intended to be mounted in an IP54 enclosure. The devices shall provide external means to prevent the rated voltage being exceeded by transient disturbances of more than 40%. This device must be used only with ATEX certified backplanes.
- D** DO NOT OPEN WHEN ENERGIZED.

Electrical Ratings

- Backplane Current Load: 800 mA @ 5 Vdc; 3 mA @ 24 Vdc
- Operating Temperature: 0 °C to 60 °C (32 °F to 140 °F)
- Storage Temperature: -40 °C to 85 °C (-40 °F to 185 °F)
- Shock: 30 g operational; 50 g non-operational; Vibration: 5 g from 10 Hz to 150 Hz
- Relative Humidity 5% to 95% (without condensation)
- All phase conductor sizes must be at least 1.3 mm (squared) and all earth ground conductors must be at least 4mm (squared).

Markings

Agency	Applicable Standards
RoHS	
CSA	IEC61010
CE	EMC-EN61326-1:2006 EN61000-6-4:2007
CSA CB Safety	CA/10533/CSA IEC 61010-1 Ed. 2 CB 243333-2056722 (2090408)
cULus	
GOST-R	EN61010
ATEX	EN60079-0 EN60079-15

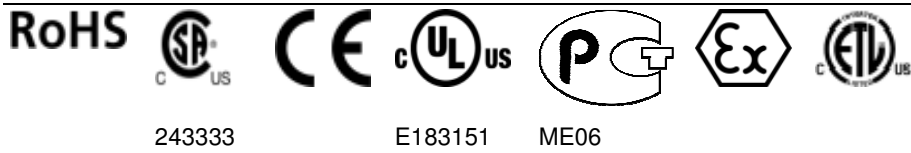

<cULus>
E183151
Class I Division 2 Groups A, B, C, and D
Temp Code T5
0°C to +60°C
Atex
Class I Division 2 Groups A, B, C, and D
Temp Code T5
0°C <= Ta <= 60°C

Battery Life Advisory

Note: Modules manufactured after April 1st, 2011 do not contain a battery. For modules manufactured before that date the following applies:

The module uses a rechargeable Lithium Vanadium Pentoxide battery to back up the real-time clock and CMOS settings. The battery itself should last for the life of the module. However, if left in an unpowered state for 14 to 21 days, the battery may become fully discharged and require recharging by being placed in a powered-up ControlLogix chassis. The time required to fully recharge the battery may be as long as 24 hours.

Once it is fully charged, the battery provides backup power for the CMOS setup and the real-time clock for approximately 21 days. Before you remove a module from its power source, ensure that the battery within the module is fully charged (the BATT LED on the front of the module goes OFF when the battery is fully charged). If the battery is allowed to become fully discharged, the module will revert to the default BIOS and clock settings.

Note: The battery is not user-replaceable or serviceable.

Contents

Your Feedback Please	2
How to Contact Us	2
ProSoft Technology® Product Documentation	2
Important Safety Information.....	3
Battery Life Advisory	4
1 Scope	7
1.1 What's New?	8
1.2 Learning Objectives.....	9
1.3 ProSoft Technology Documentation	10
1.4 Prerequisites	11
2 Before You Begin	13
2.1 System Requirements	14
2.2 Required Items	15
2.3 Sample Files.....	16
3 The Sample Application	17
3.1 About the MODBUS TCP/IP Protocol	18
3.2 General Overview.....	19
3.2.1 Required Steps.....	19
3.3 Architecture	20
3.4 Memory Map	21
4 Procedures	23
4.1 Setting Jumpers	24
4.2 Installing the Module in the Rack	25
4.3 Creating a New RSLogix 5000 Project.....	27
4.3.1 Creating the Module	28
4.3.2 Importing the Add-On Instruction	30
4.4 Connecting Your PC to the ControlLogix Processor	33
4.5 Downloading the Sample Program to the Processor	34
4.6 Using ProSoft Configuration Builder Software	35
4.6.1 Installing ProSoft Configuration Builder	35
4.6.2 Setting Up the Project	36
4.6.3 Uploading the Sample Configuration from the Module	38
4.6.4 Enabling the MNET Client 0 Commands	40
4.7 Connecting Your PC to the Module.....	43
4.7.1 Setting Up a Temporary IP Address	43
4.8 Downloading the Project to the Module	47
4.8.1 Using CIPconnect to Connect to the Module	49
4.8.2 Using RSWho to Connect to the Module	51
4.9 Configuring the NOE Ethernet adapter for Modbus TCP/IP (Server)	53
4.10 Connecting the MVI56E-MNETC Module to the Modbus TCP/IP Server.....	54

4.11	Verifying Communication.....	55
4.11.1	Viewing Exchanged Data.....	55
4.11.2	Checking Module Status through ControlLogix Controller Tags	58
4.11.3	LED Status Indicators	59
5	Building on Success	61
5.1	Frequently Asked Questions.....	62
5.1.1	What are the differences between the MVI56 and the MVI56E modules? What does the "E" stand for?.....	62
5.1.2	What is the difference between the MVI56E-MNET(R) and the MVI56E-MNETC(R)?	63
5.1.3	Is the MVI56E product a direct replacement to my existing MVI56 product?.....	63
5.1.4	How is the MVI56E-MNETC configured?	63
5.1.5	What is ProSoft Configuration Builder (PCB)?	63
5.1.6	What is the purpose of the MVI56E-MNETC Ethernet (E1) Port?.....	63
5.1.7	How do I change the module's IP address?	64
5.1.8	What is the purpose of the Optional MVI56E-MNETC Add-On Instruction?	64
5.1.9	What is ProSoft Discovery Service (PDS)?	64
5.1.10	Does the MVI56E-MNETC module require processor logic?	64
5.1.11	How do I monitor MVI56E-MNETC operation?.....	65
5.1.12	Are there any other ways to monitor module diagnostics besides being connected to the module's network (subnet)?	65
	Glossary of Terms	67
	Index	71

1 Scope

In This Chapter

❖ What's New?	8
❖ Learning Objectives.....	9
❖ ProSoft Technology Documentation.....	10
❖ Prerequisites	11

This document acts as a tutorial, providing step-by-step instructions on how to read and write bi-directional data from one network device to another network device using the MVI56E-MNETC.

1.1 What's New?

MVI56E products are **backward compatible** with existing MVI56 products, ladder logic, and module configuration files already in use. Easily swap and upgrade products while benefiting from an array of new features designed to improve interoperability and enhance ease-of-use.

- **ProSoft Configuration Builder (PCB):** New Windows software for diagnostics, connecting via the module's Ethernet port or CIPconnect[®], to upload/download module configuration information and access troubleshooting features and functions.
- **ProSoft Discovery Service (PDS):** Utility software to find and display a list of MVI56E modules on the network and to temporarily change an IP address to connect with a module's web page.
- **CIPconnect-enabled:** Allows PC-to-module configuration and diagnostics from the Ethernet network through a ControlLogix 1756-ENBT EtherNet/IP[™] module.
- **Personality Module:** An industrial compact flash memory card storing the module's complete configuration and Ethernet settings, allowing quick and easy replacement.
- **LED Scrolling Diagnostic Display:** 4-character, alphanumeric display, providing standard English messages for status and alarm data, and for processor and network communication status.

1.2 Learning Objectives

When you have completed all the steps in this Setup Guide, you will have learned how to

- Understand how the sample application works (page 17)
- Install the MVI56E-MNETC configuration software
- Install the MVI56E-MNETC module
- Import the Add-On Instruction to the processor (page 34)
- Configure the Modbus TCP/IP Client (page 40)
- Verify the MVI56E-MNETC module communication status (page 55)

1.3 ProSoft Technology Documentation

ProSoft Technology provides the following documentation (manuals) with your MVI56E-MNETC.

Documentation, tools, and product support

- **Web Site Support:** Visit the ProSoft Technology web site at www.prosoft-technology.com to download additional documentation, tools, and application information.
- **Email Technical Support:** Send your support questions to Support@prosoft-technology.com.
- **Telephone Support:** Please call ProSoft Technology Technical Support at: (Country Code 1+) 661-716-5100. Support is available 24 hours a day, 7 days a week. ProSoft Technology telephone support is free and unlimited.

1.4 Prerequisites

To get the most benefit from this setup guide, you should have the following skills:

- **Rockwell Automation® RSLogix™ 5000 software:** launch the program, configure and transfer the Add-On Instruction to the processor
- **Microsoft Windows:** install and launch programs, execute menu commands, navigate dialog boxes and enter data.
- **Ethernet networking:** connect the MVI56E-MNETC module to an Ethernet network using a valid IP address and subnet mask
- **Hardware installation and wiring:** install the module and safely connect Modbus TCP/IP Client and ControlLogix devices to a power source and to the MVI56E-MNETC module's Ethernet port

2 Before You Begin

In This Chapter

- ❖ System Requirements 14
- ❖ Required Items 15
- ❖ Sample Files..... 16

2.1 System Requirements

The MVI56E-MNETC module requires the following minimum hardware and software components:

- Rockwell Automation ControlLogix[®] processor (firmware version 10 or higher), with compatible power supply, and one free slot in the rack for the MVI56E-MNETC module. The module requires 800 mA of available 5 Vdc power
- Rockwell Automation RSLogix 5000 programming software
 - Version 16 or higher required for Add-On Instruction
 - Version 15 or lower must use Sample Ladder, available from www.prosoft-technology.com
- Rockwell Automation RSLinx[®] communication software version 2.51 or higher
- ProSoft Configuration Builder (PCB) (included)
- ProSoft Discovery Service (PDS) (included in PCB)
- Pentium[®] II 450 MHz minimum. Pentium III 733 MHz (or better) recommended
- Supported operating systems:
 - Microsoft Windows[®] Vista
 - Microsoft Windows XP Professional with Service Pack 1 or 2
 - Microsoft Windows 2000 Professional with Service Pack 1, 2, or 3
 - Microsoft Windows Server 2003
- 128 Mbytes of RAM minimum, 256 Mbytes of RAM recommended
- 100 Mbytes of free hard disk space (or more based on application requirements)
- 256-color VGA graphics adapter, 800 x 600 minimum resolution (True Color 1024 × 768 recommended)
- CD-ROM drive

Note: The Hardware and Operating System requirements in this list are the minimum recommended to install and run software provided by ProSoft Technology[®]. Other third party applications may have different minimum requirements. Refer to the documentation for any third party applications for system requirements.

Note: You can install the module in a local or remote rack. For remote rack installation, the module requires EtherNet/IP or ControlNet communication with the processor.

2.2 Required Items

This Setup Guide uses a sample application that shows you how to establish communication between the MVI56E-MNETC module (Modbus TCP/IP Client) and a Modbus TCP/IP Server device. The sample application requires the following equipment.

Item	Description
MVI56E-MNETC	Modbus TCP/IP Multi Client Enhanced Communication Module
1756-L63	ControlLogix processor
1756-A7/B	1 ControlLogix rack
1756-PA72/B	1 ControlLogix rack power supply
CPU434 12A	Quantum processor (Modbus device)
CPS 114 20	Quantum power supply
140XBP01000	Quantum rack
140NOE77111	NOE Card
Ethernet cable	Ethernet cable to connect MVI56E-MNETC module to Ethernet network for Modbus TCP/IP communication and diagnostics (supplied with the module)

2.3 Sample Files

Note: This procedure requires RSLogix 5000 version 16 (or later), which supports Add-On Instructions. For RSLogix version 15 (or older) applications, please refer to the *MVI56E-MNETC User Manual* for information on how to use the sample ladder logic.

The sample MVI56EMNETC_AddOn_Rung_v1_5.L5X Add-On Instruction file contains all elements required for the MVI56E-MNETC module to function.

- User-defined Data Types (UDTs)
- Add-On Instruction (AOI)
- Ladder rung with AOI
- Controller tags

Item	Description
MVI56EMNETC_AddOn_Rung_v1_5.L5X	Sample rung import file containing Add-On Instruction

Copy the file from the *ProSoft Solutions CD-ROM*, or download them from www.prosoft-technology.com. Save it to a convenient location in your PC, such as *Desktop* or *My Documents*.

3 The Sample Application

In This Chapter

❖ About the MODBUS TCP/IP Protocol.....	18
❖ General Overview.....	19
❖ Architecture	20
❖ Memory Map	21

3.1 About the MODBUS TCP/IP Protocol

MODBUS is a widely used protocol originally developed by Modicon in 1978. Since that time, the protocol has been adopted as a standard throughout the automation industry.

The original MODBUS specification uses a serial connection to communicate commands and data between Client and server devices on a network. Later enhancements to the protocol allow communication over Ethernet networks using TCP/IP as a "wrapper" for the MODBUS protocol. This protocol is known as MODBUS TCP/IP.

MODBUS TCP/IP is a Client/server protocol. The Client establishes a connection to the remote server. When the connection is established, the Client sends the MODBUS TCP/IP commands to the server. The MVI56E-MNETC module works both as a Client and as a server.

Aside from the benefits of Ethernet versus serial communications (including performance, distance, and flexibility) for industrial networks, the MODBUS TCP/IP protocol allows for remote administration and control of devices over a TCP/IP network. The efficiency, scalability, and low cost of a MODBUS TCP/IP network make this an ideal solution for industrial applications.

The MVI56E-MNETC module acts as an input/output module between devices on a MODBUS TCP/IP network and the Rockwell Automation backplane. The module uses an internal database to pass data and commands between the processor and the Client and server devices on the MODBUS TCP/IP network.

3.2 General Overview

This Setup Guide shows you how to configure the MVI56E-MNETC module and establish communication with a Modbus TCP/IP device (a Quantum processor with a NOE Ethernet adapter, for this example).

The MVI56E-MNETC Ethernet application port will be configured as a Modbus TCP/IP (MNET) Client device. The NOE Ethernet adapter will operate as a Modbus TCP/IP Server device, passing data to the Quantum processor. The MVI56E-MNETC will be configured to send two MNET Client commands to the Modbus TCP/IP Server device:

- Write 10 words (Modbus Function 16 - Preset [Write] Multiple Registers)
- Read 10 words (Modbus Function 3 - Read Holding Registers)

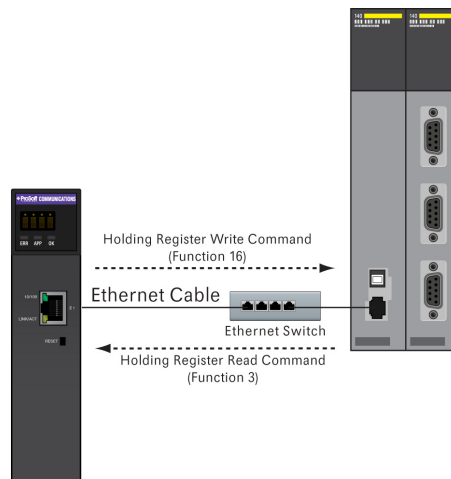

When you finish the steps in this Setup Guide, you will have enough information to set up your own application.

3.2.1 Required Steps

This Setup Guide will take you through the following steps:

- 1 Install the ProSoft Module in the rack
- 2 Use the Add-On Instruction to Configure the Module (page 27)
- 3 Connect your PC to the Processor (page 33)
- 4 Download the Sample Program to the Processor (page 34)
- 5 Set up the Sample Application (page 38)
 - a Configure the Modbus TCP/IP Client
 - b Configure the Modbus TCP/IP Client Read Command
 - c Configure the Modbus TCP/IP Client Write Command (page 41, page 42)
- 6 Transfer the configuration to the module (page 47)
- 7 Set up the NOE Modbus TCP/IP Server (page 53)
- 8 Verify Communication (page 55)

3.3 Architecture

The sample application uses the following hardware and connections.

- A Personal Computer running a supported version of Microsoft Windows, with a web browser, RSLogix 5000, ProSoft Discovery Service and an Ethernet port
- A ControlLogix processor with MVI56E-MNETC module acting as a Modbus TCP/IP Client
- A Quantum processor with a NOE Ethernet adapter acting as a Modbus TCP/IP Server
- An Ethernet network connecting the PC with the MVI56E-MNETC, either directly, or through an Ethernet hub or switch.
- An Ethernet cable connecting the MVI56E-MNETC Modbus TCP/IP Client to the Modbus TCP/IP Server.

The following illustration shows the sample application.

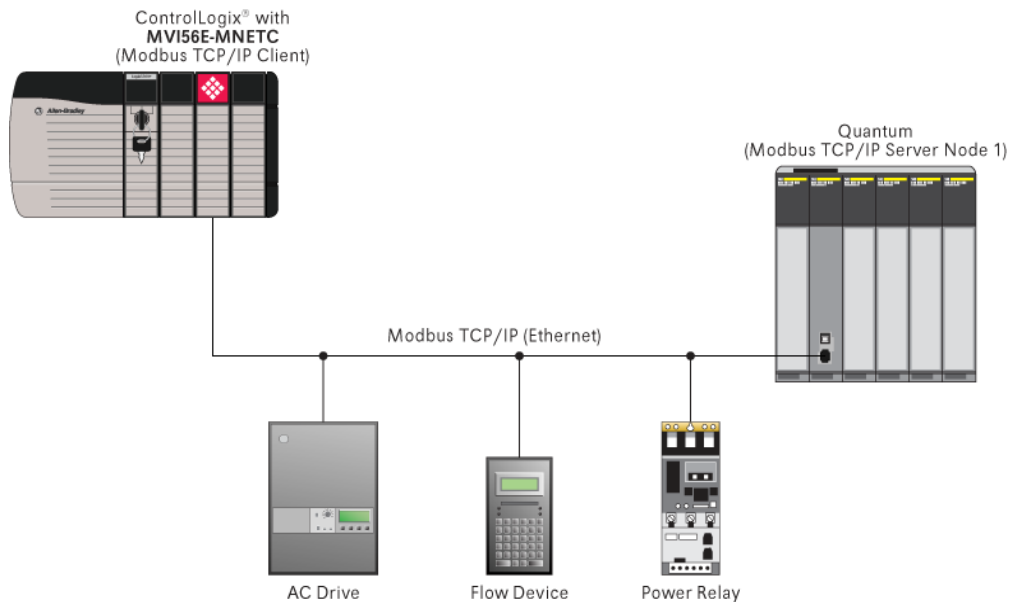

Note: The illustration does not show the required Ethernet connection for processor programming.

3.4 Memory Map

The memory map consists of the starting addresses for Read Data and Write Data areas in the MVI56E-MNETC module and in the Quantum processor. The sample application reads and writes 10 words between the Modbus TCP/IP Client and the Modbus TCP/IP Server.

The following table describes the memory map for data transfer between the MVI56E-MNETC module and the Quantum processor.

Function	MVI56E-MNETC Database Start Address (Client)	Quantum Memory Start Address (Server)	Word Count
Read	1000	400801	10
Write	0	400401	10

4 Procedures

In This Chapter

❖ Setting Jumpers	24
❖ Installing the Module in the Rack.....	25
❖ Creating a New RSLogix 5000 Project	27
❖ Connecting Your PC to the ControlLogix Processor.....	33
❖ Downloading the Sample Program to the Processor	34
❖ Using ProSoft Configuration Builder Software.....	35
❖ Connecting Your PC to the Module	43
❖ Downloading the Project to the Module	47
❖ Configuring the NOE Ethernet adapter for Modbus TCP/IP (Server)	53
❖ Connecting the MVI56E-MNETC Module to the Modbus TCP/IP Server	54
❖ Verifying Communication.....	55

4.1 Setting Jumpers

The Setup Jumper acts as "write protection" for the module's flash memory. In "write protected" mode, the Setup pins are not connected, and the module's firmware cannot be overwritten. Do not jumper the Setup pins together unless you are directed to do so by ProSoft Technical Support.

The following illustration shows the MVI56E-MNETC jumper configuration.

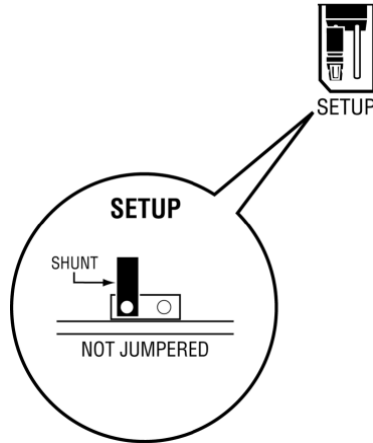

Note: If you are installing the module in a remote rack, you may prefer to leave the Setup pins jumpered. That way, you can update the module's firmware without requiring physical access to the module.

4.2 Installing the Module in the Rack

If you have not already installed and configured your ControlLogix processor and power supply, please do so before installing the MVI56E-MNETC module. Refer to your Rockwell Automation product documentation for installation instructions.

Warning: You must follow all safety instructions when installing this or any other electronic devices. Failure to follow safety procedures could result in damage to hardware or data, or even serious injury or death to personnel. Refer to the documentation for each device you plan to connect to verify that suitable safety procedures are in place before installing or servicing the device.

After you have checked the placement of the jumpers, insert the MVI56E-MNETC into the ControlLogix chassis. Use the same technique recommended by Rockwell Automation to remove and install ControlLogix modules.

You can install or remove ControlLogix system components while chassis power is applied and the system is operating. However, please note the following warning.

Warning: When you insert or remove the module while backplane power is on, an electrical arc can occur. An electrical arc can cause personal injury or property damage by sending an erroneous signal to your system's actuators. This can cause unintended machine motion or loss of process control. Electrical arcs may also cause an explosion when they happen in a hazardous environment. Verify that power is removed or the area is non-hazardous before proceeding. Repeated electrical arcing causes excessive wear to contacts on both the module and its mating connector. Worn contacts may create electrical resistance that can affect module operation.

- 1 Align the module with the top and bottom guides, and then slide it into the rack until the module is firmly against the backplane connector.

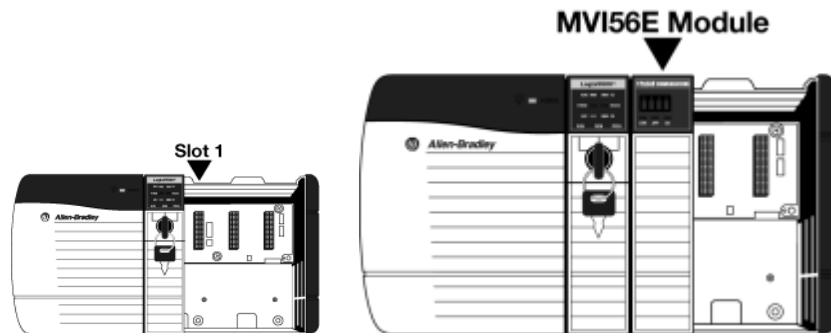

- 2 With a firm, steady push, snap the module into place.
- 3 Check that the holding clips on the top and bottom of the module are securely in the locking holes of the rack.
- 4 Make a note of the slot location. You must identify the slot in which the module is installed in order for the sample program to work correctly. Slot numbers are identified on the green circuit board (backplane) of the ControlLogix rack.
- 5 Turn power ON.

Note: If you insert the module improperly, the system may stop working or may behave unpredictably.

4.3 Creating a New RSLogix 5000 Project

- 1 Open the **FILE** menu, and then choose **NEW**.

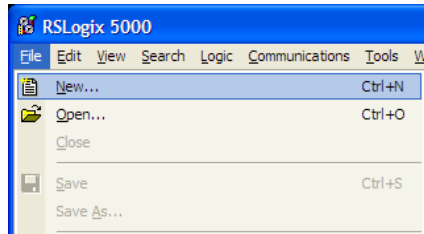

- 2 Select your ControlLogix controller model.
- 3 Select **REVISION 16**.
- 4 Enter a name for your controller, such as *My_Controller*.
- 5 Select your ControlLogix chassis type.
- 6 Select **SLOT 0** for the controller.

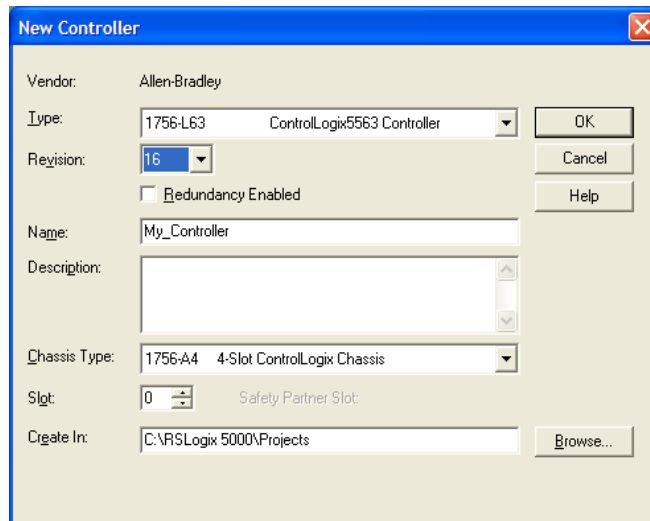

4.3.1 Creating the Module

1 Add the MVI56E-MNETC module to the project.

In the *Controller Organization* window, select **I/O CONFIGURATION** and click the right mouse button to open a shortcut menu. On the shortcut menu, choose **NEW MODULE**.

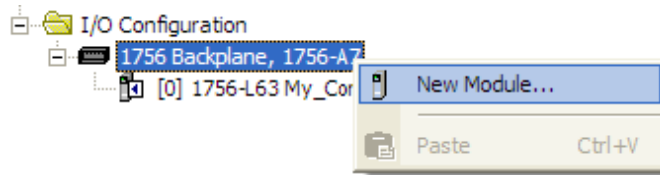

This action opens the *Select Module* dialog box.

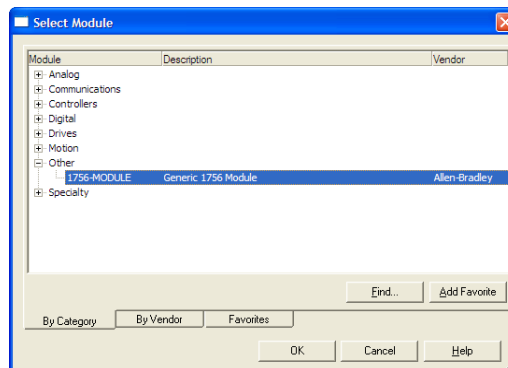

2 Select the 1756-MODULE (GENERIC 1756 MODULE) from the list and click OK.

This action opens the *New Module* dialog box.

3 In the *New Module* dialog box, enter the following values.

Parameter	Value
Name	Enter a module identification string. Example: MNETC
Description	Enter a description for the module. Example: MODBUS TCP/IP MULTI CLIENT ENHANCED COMMUNICATION MODULE
Comm Format	Select DATA-INT .
Slot	Enter the slot number in the rack where the MVI56E-MNETC module is located.
Input Assembly Instance	1
Input Size	250
Output Assembly Instance	2
Output Size	248
Configuration Assembly Instance	4
Configuration Size	0

Important: You must select the *Comm Format* as **DATA - INT** in the dialog box, otherwise the module will not communicate over the backplane of the ControlLogix rack.

- 4 Click **OK** to continue.
- 5 Edit the Module Properties. Select the *Requested Packet Interval* value for scanning the I/O on the module. This value represents the minimum frequency at which the module will handle scheduled events. This value should not be set to less than 1 millisecond. The default value is 5 milliseconds. Values between 1 and 10 milliseconds should work with most applications.

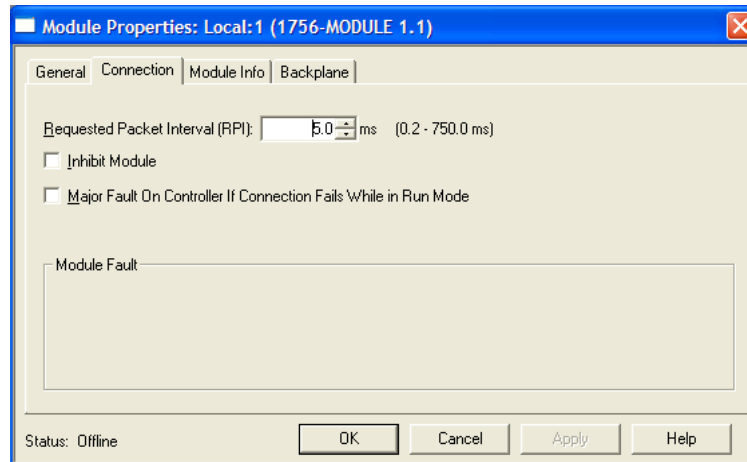

6 Save the module.

Click **OK** to close the dialog box. Notice that the module now appears in the *Controller Organization* window.

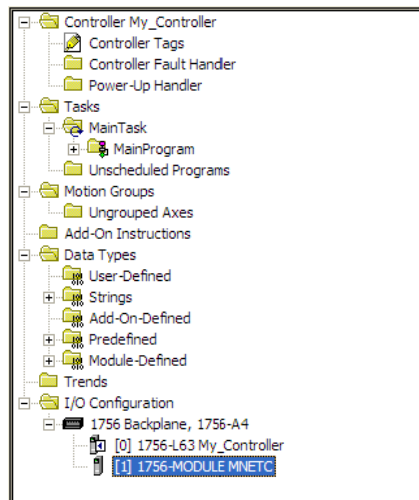

4.3.2 Importing the Add-On Instruction

- 1 In the *Controller Organization* window, expand the **TASKS** folder and subfolder until you reach the **MAINPROGRAM** folder.
- 2 In the **MAINPROGRAM** folder, double-click to open the **MAINROUTINE** ladder.
- 3 Select an empty rung in the new routine, and then click the right mouse button to open a shortcut menu. On the shortcut menu, choose **IMPORT RUNG**.

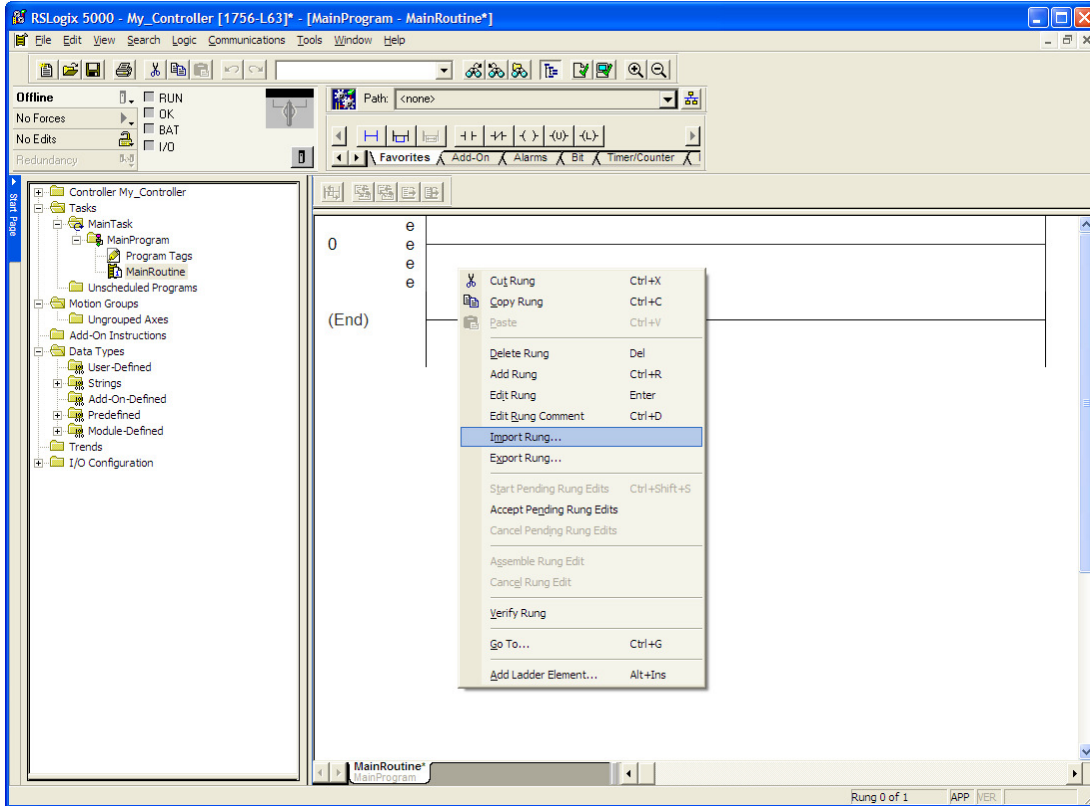

- 4 Navigate to the location on your PC where you saved the Add-On Instruction (for example, *My Documents* or *Desktop*). Select the **MVI56EMNETC_ADDON_RUNG_v1_5.L5X** file.

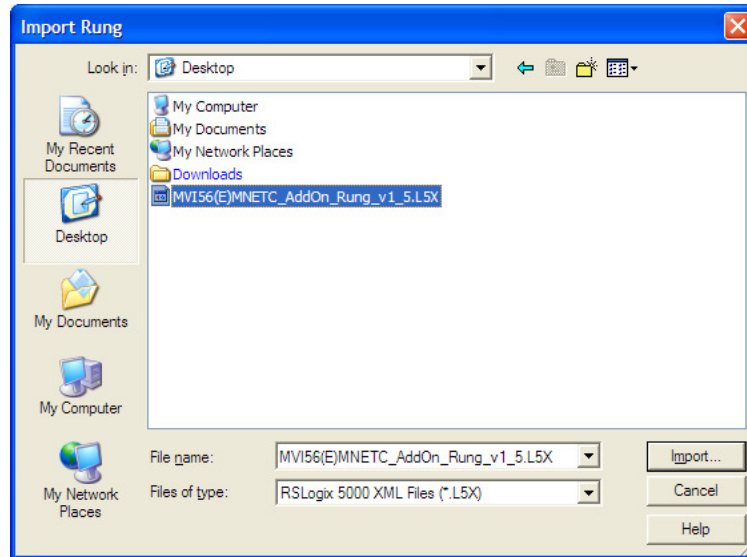

This action opens the *Import Configuration* dialog box, showing the controller tags that will be created.

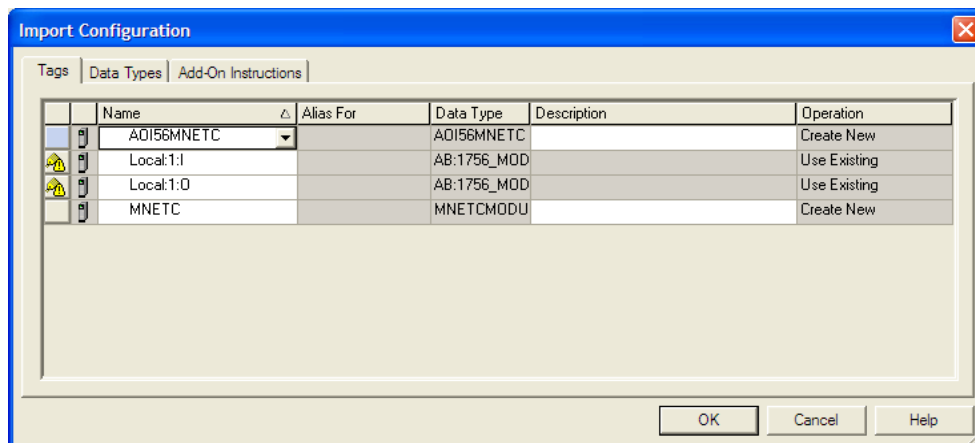

- 5 If you are using the module in a different slot (or remote rack), select the correct connection input and output variables that define the path to the module. If your module is located in Slot 1 of the local rack, this step is not required.

- Click **OK** to confirm the import. RSLogix will indicate that the import is in progress:

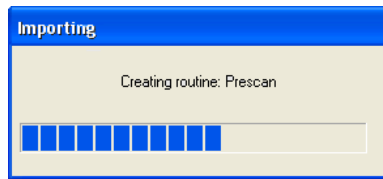

When the import is completed, the new rung with the Add-On Instruction will be visible as shown in the following illustration.

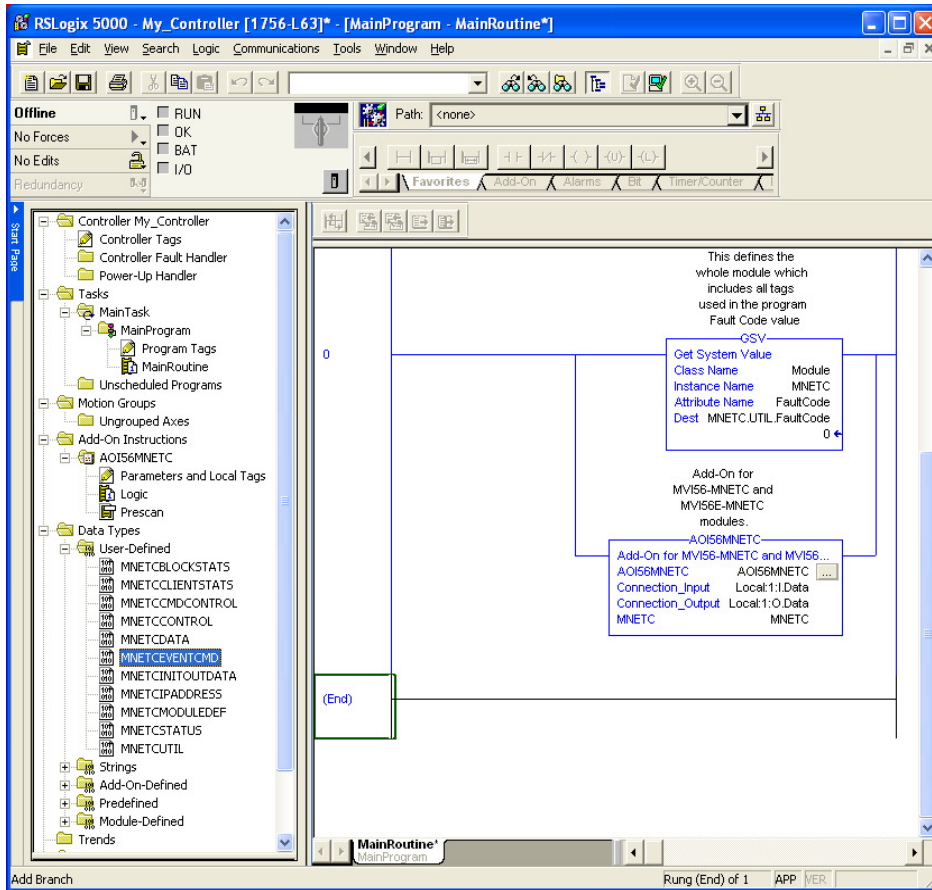

The procedure has also imported new user-defined data types, data objects and the Add-On Instruction for your project.

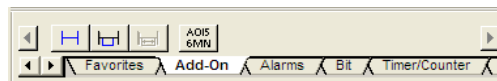

- Save the application and then download the sample ladder logic to the processor.

4.4 Connecting Your PC to the ControlLogix Processor

There are several ways to establish communication between your PC and the ControlLogix processor. The following steps show how to establish communication through the serial interface. It is not mandatory that you use the processor's serial interface. You may access the processor through whatever network interface is available on your system. Refer to your Rockwell Automation documentation for information on other connection methods.

- 1 Connect the right-angle connector end of the cable to your controller at the communications port.

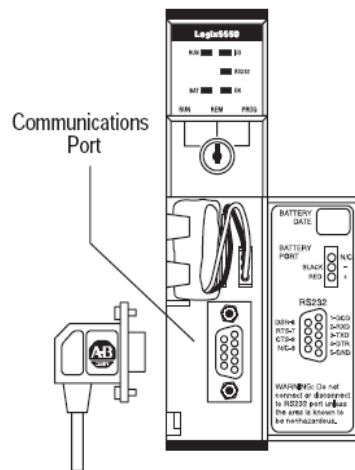

- 2 Connect the straight connector end of the cable to the serial port on your computer.

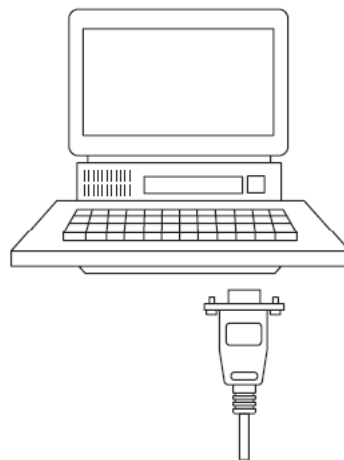

4.5 Downloading the Sample Program to the Processor

Note: The key switch on the front of the ControlLogix processor must be in the REM or PROG position.

- 1 If you are not already online with the processor, open the *Communications* menu, and then choose **DOWNLOAD**. RSLogix 5000 will establish communication with the processor. You do not have to download through the processor's serial port, as shown here. You may download through any available network connection.
- 2 When communication is established, RSLogix 5000 will open a confirmation dialog box. Click the **DOWNLOAD** button to transfer the sample program to the processor.

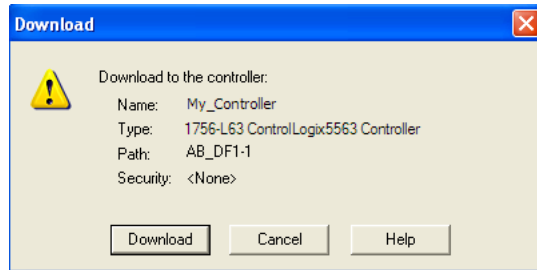

- 3 RSLogix 5000 will compile the program and transfer it to the processor. This process may take a few minutes.
- 4 When the download is complete, RSLogix 5000 will open another confirmation dialog box. If the key switch is in the REM position, click **OK** to switch the processor from PROGRAM mode to RUN mode.

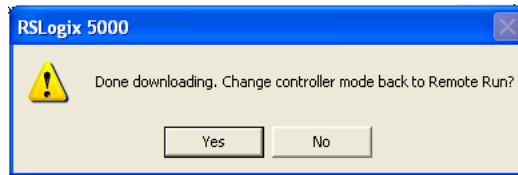

Note: If you receive an error message during these steps, refer to your RSLogix documentation to interpret and correct the error.

4.6 Using ProSoft Configuration Builder Software

ProSoft Configuration Builder (PCB) provides a quick and easy way to manage gateway configuration files customized to meet your application needs. *PCB* is not only a powerful solution for new configuration files, but also allows you to import information from previously installed (known working) configurations to new projects.

Note: During startup and initialization, the MVI56E-MNETC module receives its protocol and backplane configuration information from the installed Personality Module (Compact Flash). Use *ProSoft Configuration Builder* to configure module settings and to download changes to the Personality Module.

4.6.1 Installing ProSoft Configuration Builder

To install ProSoft Configuration Builder from the CD-ROM

- 1 Insert the *ProSoft Solutions* CD-ROM into the CD drive of your PC. Wait for the startup screen to appear.

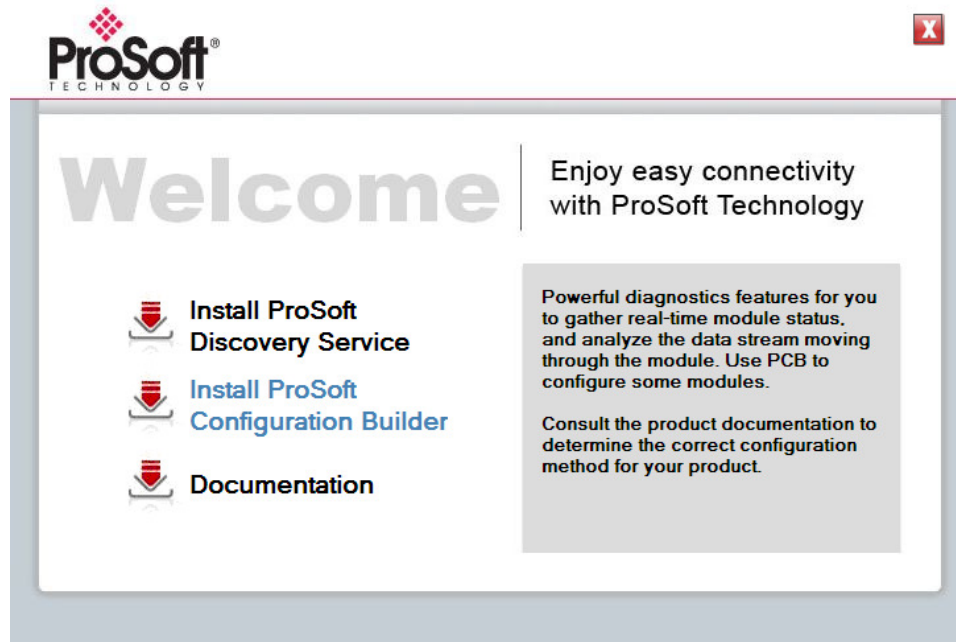

- 2 On the startup screen, click **INSTALL PROSOFT CONFIGURATION BUILDER**. This action starts the installation wizard for *ProSoft Configuration Builder*.
- 3 Click **NEXT** on each page of the installation wizard. Click **FINISH** on the last page of the wizard.

4.6.2 Setting Up the Project

To begin, start **PROSOFT CONFIGURATION BUILDER (PCB)**.

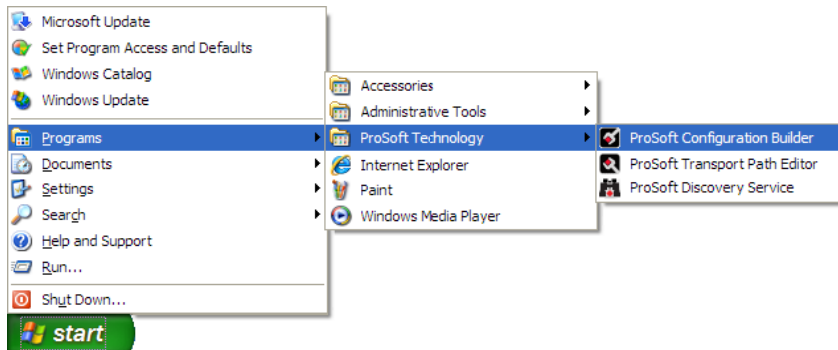

If you have used other Windows configuration tools before, you will find the screen layout familiar. *PCB's* window consists of a tree view on the left, and an information pane and a configuration pane on the right side of the window. When you first start *PCB*, the tree view consists of folders for *Default Project* and *Default Location*, with a *Default Module* in the *Default Location* folder. The following illustration shows the *PCB* window with a new project.

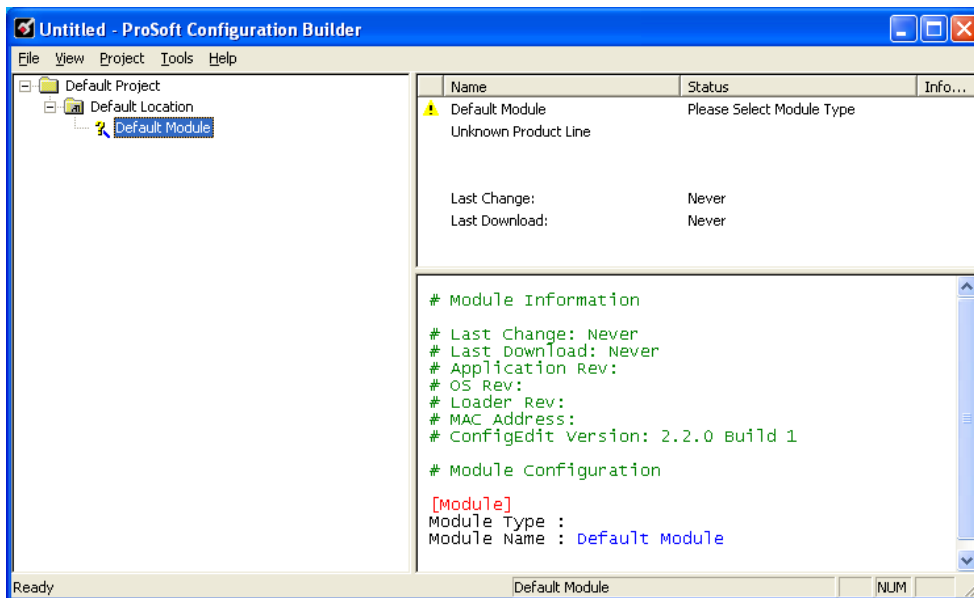

Your first task is to add the MVI56E-MNETC module to the project.

- 1 Use the mouse to select **DEFAULT MODULE** in the tree view, and then click the right mouse button to open a shortcut menu.

- 2 On the shortcut menu, select **CHOOSE MODULE TYPE**. This action opens the *Choose Module Type* dialog box.

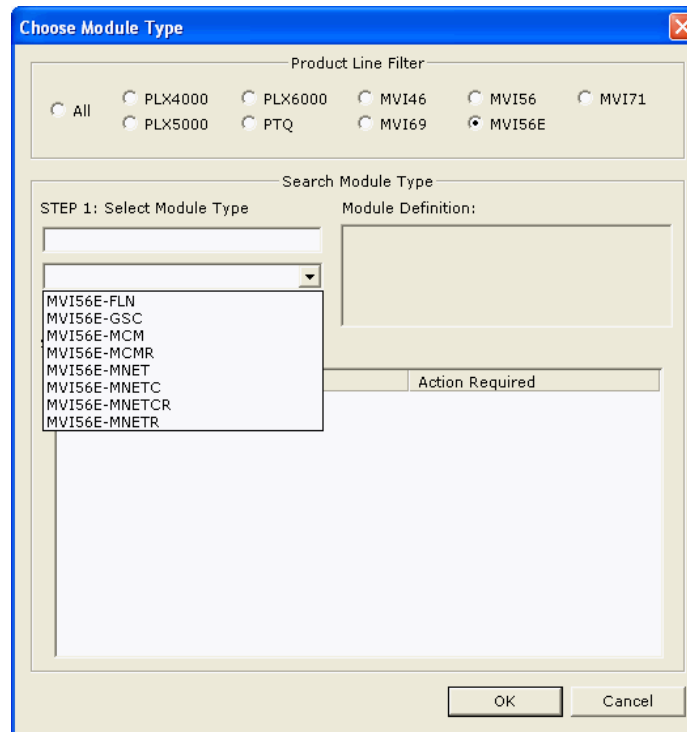

- 3 In the *Product Line Filter* area of the dialog box, select **MVI56E**. In the *Select Module Type* dropdown list, select **MVI56E-MNETC**, and then click **OK** to save your settings and return to the *ProSoft Configuration Builder* window.

4.6.3 Uploading the Sample Configuration from the Module

The MVI56E-MNETC module contains a sample configuration file, with configuration parameters that match the sample application in this Setup Guide. To retrieve the sample configuration file, follow these steps.

- 1 In ProSoft Configuration Builder, select the **MVI56E-MNETC** module, and then click the right mouse button to open a shortcut menu. On the shortcut menu, choose **UPLOAD FROM DEVICE TO PC**.

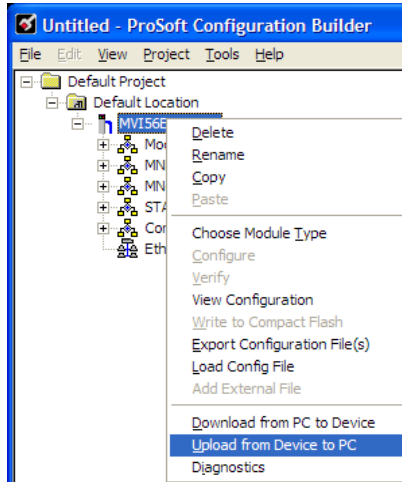

This action opens the *Upload Files* dialog box.

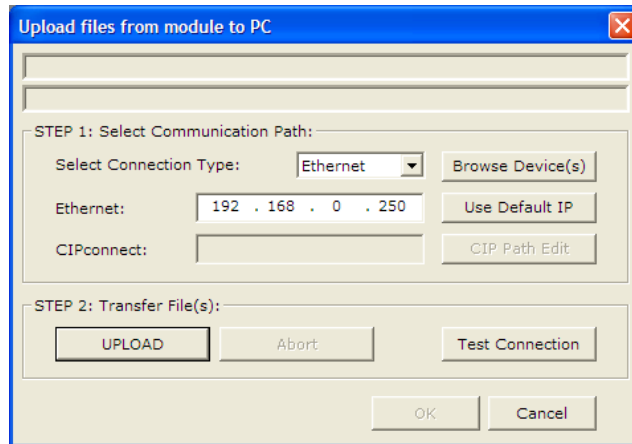

- In the *Upload Files* dialog box, click **BROWSE DEVICES** to locate the MVI56E-MNETC module. This action opens the *ProSoft Discovery Service* dialog box. Select the module, and then click the right mouse button to open a shortcut menu. On the shortcut menu, choose **SELECT FOR PCB**. This action places the module's Ethernet address in the Upload Files dialog box.

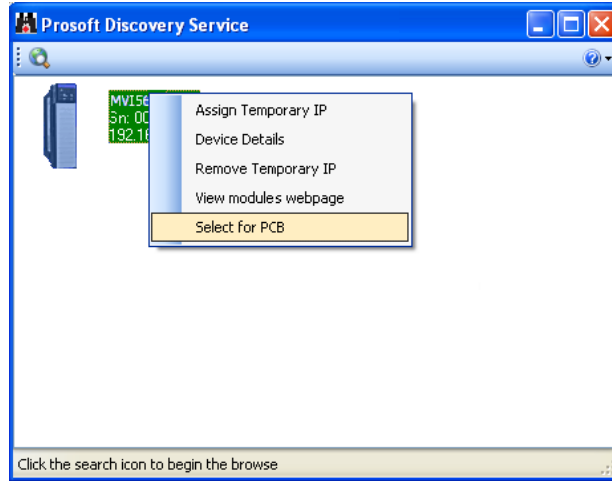

- Click the **X** in the top right corner to close the *ProSoft Discovery Service* dialog box.
- In the *Upload Files* dialog box, click **UPLOAD**. When the upload is complete, as shown in the following illustration, click the **OK** button.

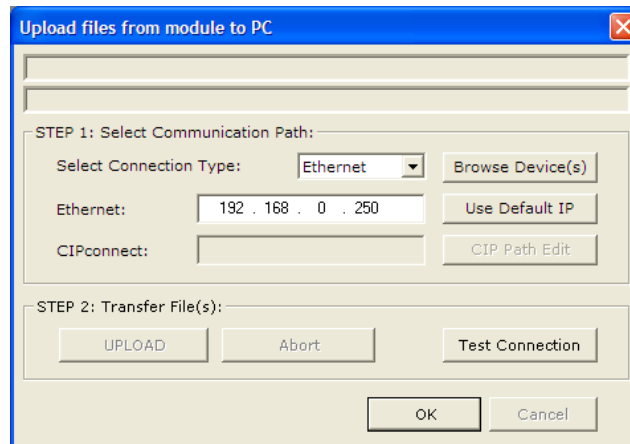

ProSoft Configuration Builder now contains the sample configuration for your MVI56E-MNETC module. In the following steps, you will configure the Read and Write commands.

4.6.4 Enabling the MNET Client 0 Commands

The default module configuration contains two Modbus Client commands associated with MNET Client 0. In the default configuration file, these commands are disabled.

- 1 To enable the commands, expand the **MVI56E-MNETC** node in ProSoft Configuration Builder until the **MNET CLIENT 0 COMMANDS** tag is visible.

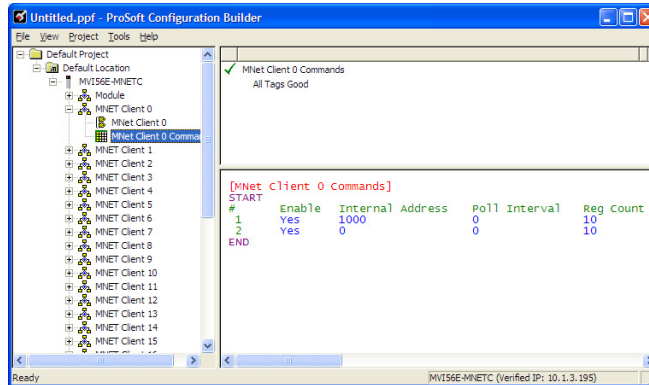

- 2 Double-click the **MNET CLIENT 0 COMMANDS** tag to open the *Edit MNET Client 0 Commands* dialog box.

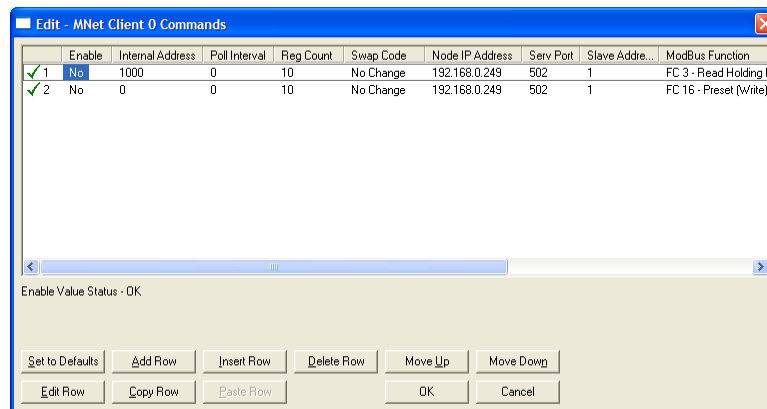

Select the first command in the list, and then click **EDIT ROW**.

Important: The commands must also be enabled in the ladder logic in order for them to be executed. The *MNETC.CONTROL.CmdControl.WriteCmdBits[x]* controller tag array holds 16-command bit arrays for each Client. If a bit for a specific command is set to zero (0) in the *WriteCmdBits[x]* controller tag, the command will not be executed, regardless of its enabled or disabled state in the configuration.

Configuring the Modbus Client Read Command

The Modbus Read Command reads 10 words of data from the Quantum processor (Modbus Slave) and transfers it to the MVI56E-MNETC module's internal database. The following table describes the relationship between memory addresses in the Modbus Master (MVI56E-MNETC) and the Modbus Slave (Quantum processor).

MVI56E-MNETC Database Address	Quantum Memory Address
1000	400801
1001	400802
1002	400803
1003	400804
1004	400805
1005	400806
1006	400807
1007	400808
1008	400809
1009	400810

In the sample configuration, the Modbus Read Command is present, but disabled. To enable the command, change the **ENABLE** field from No to **YES**, as shown in the following illustration.

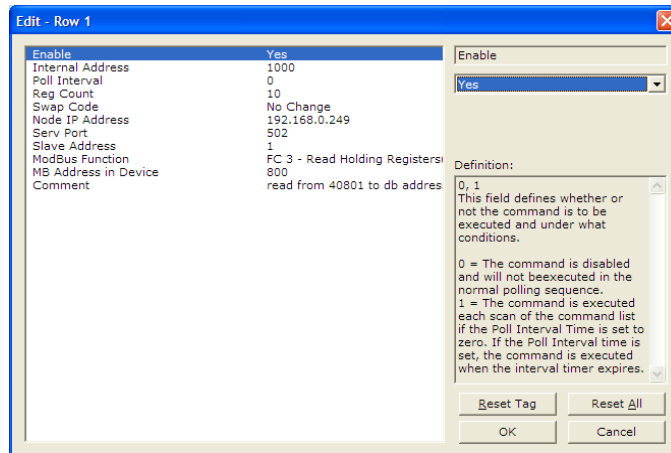

Notes:

- FC 3 represents Modbus Function Code 3, the command code to Read Holding Registers
- The DevAddress parameter is 0-based so 800 = 400801, 801 = 400802, and so on.
- The Enable code must be set to 1 to enable the command (0 = disable)
- The destination Slave node address must be set as 1 (Node parameter)

Configuring the Modbus Client Write Command

The Modbus Write Command will write data from the MVI56E-MNETC module to the Quantum processor as follows.

MVI56E-MNETC Database Address	Quantum Memory Address
0	400401
1	400402
2	400403
3	400404
4	400405
5	400406
6	400407
7	400408
8	400409
9	400411

In the sample configuration, a Modbus Write Command is present, but disabled. To enable this command, change the **ENABLE** field from No to **YES**, as shown in the following illustration.

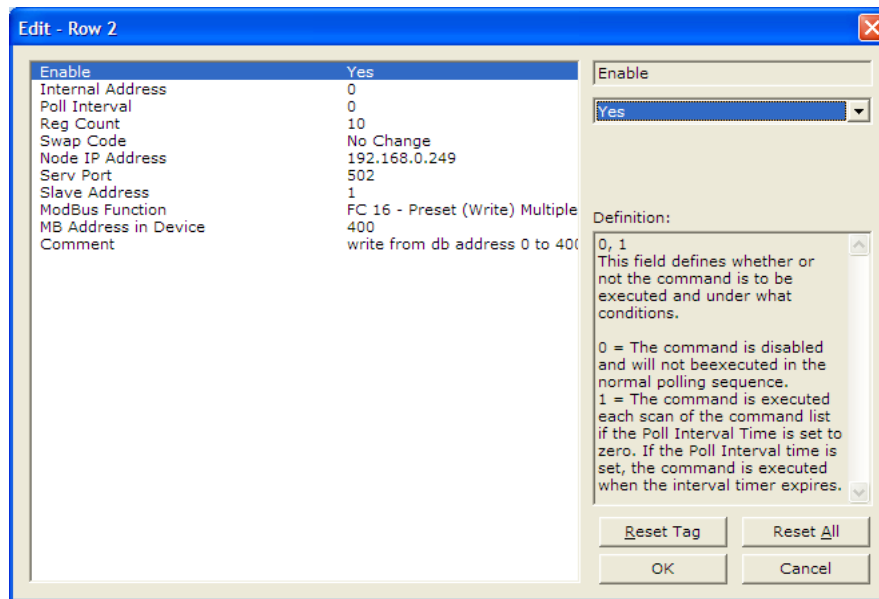

Notes:

- Func 16 represents Modbus Function Code 16, the command code to Preset (Write) Holding Registers
- The **DEVADDRESS** parameter is 0-based so 400 = 400401, 401 = 400402, and so on.
- The **ENABLE** code must be set to 1 to enable the command (0 = disable).
- The destination Slave node address must be set as 1 (Node parameter)

4.7 Connecting Your PC to the Module

With the module securely mounted, connect one end of the Ethernet cable to the *Config (E1)* Port, and the other end to an Ethernet hub or switch accessible from the same network as your PC. You can also connect directly from the Ethernet Port on your PC to the *Config (E1)* Port on the module by using an Ethernet crossover cable (not included).

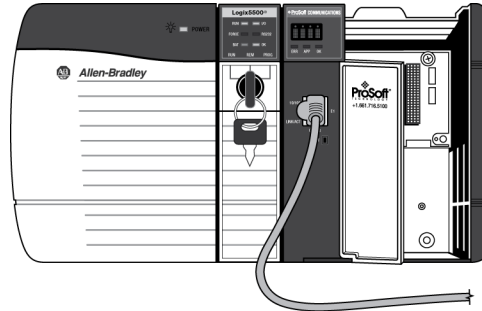

4.7.1 Setting Up a Temporary IP Address

Important: *ProSoft Configuration Builder* locates MVI56E-MNETC modules through UDP broadcast messages. These messages may be blocked by routers or layer 3 switches. In that case, *ProSoft Discovery Service* will be unable to locate the modules. To use *ProSoft Configuration Builder*, arrange the Ethernet connection so that there is no router/ layer 3 switch between the computer and the module OR reconfigure the router/ layer 3 switch to allow routing of the UDP broadcast messages.

- 1 In the tree view in *ProSoft Configuration Builder*, select the **MVI56E-MNETC** module.

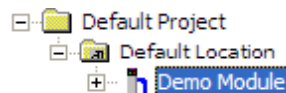

- 2 Click the right mouse button to open a shortcut menu. On the shortcut menu, choose **DIAGNOSTICS**.

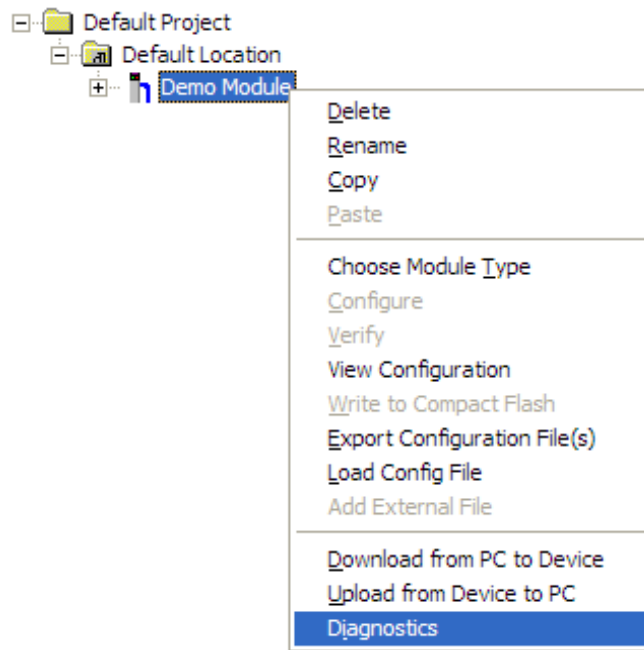

- 3 In the *Diagnostics* window, click the **SET UP CONNECTION** button.



- 4 In the *Connection Setup* dialog box, click the **BROWSE DEVICE(S)** button to open the *ProSoft Discovery Service*. Select the module, then right-click and choose **ASSIGN TEMPORARY IP**.

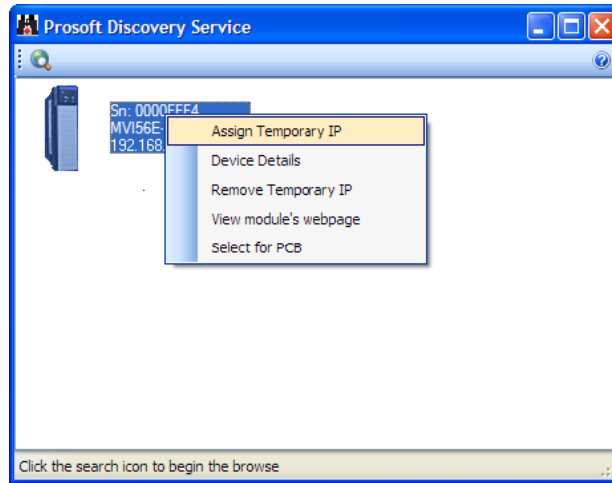

- 5 The module's default IP address is usually 192.168.0.250. Choose an unused IP within your subnet, and then click **OK**.

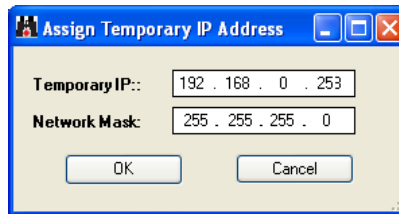

Important: The temporary IP address is only valid until the next time the module is initialized. For information on how to set the module's permanent IP address, see the user manual's Ethernet Configuration section.

- 6 Close the *ProSoft Discovery Service* window. Enter the temporary IP in the Ethernet address field of the *Connection Setup* dialog box, then click the **TEST CONNECTION** button to verify that the module is accessible with the current settings.

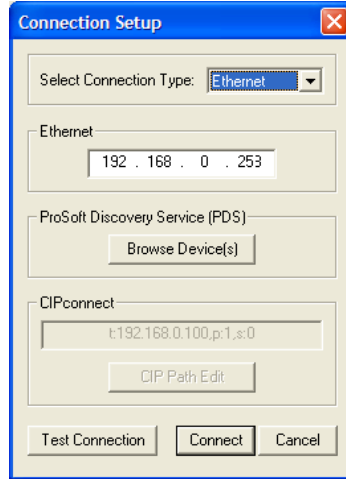

- 7 If the *Test Connection* is successful, click **CONNECT**. The *Diagnostics* menu will display in the *Diagnostics* window.

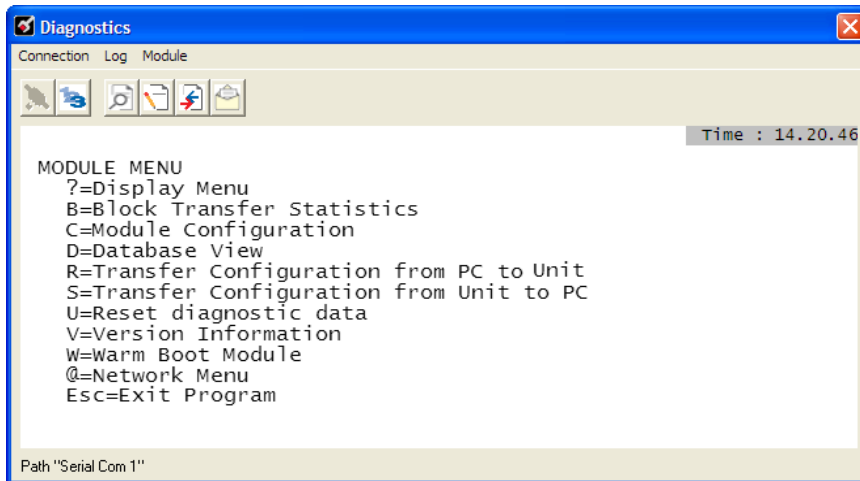

4.8 Downloading the Project to the Module

Note: For alternative methods of connecting to the module with your PC, refer to Using CIPconnect to Connect to the Module (page 49) or Using RSWho to Connect to the Module (page 51).

In order for the module to use the settings you configured, you must download (copy) the updated Project file from your PC to the module.

- 1 In the tree view in *ProSoft Configuration Builder*, click once to select the **MVI56E-MNETC** module.

- 2 Open the **PROJECT** menu, and then choose **MODULE / DOWNLOAD**.

This action opens the *Download* dialog box. Notice that the Ethernet address field contains the temporary IP address you assigned previously. *ProSoft Configuration Builder* will use this temporary IP address to connect to the module.

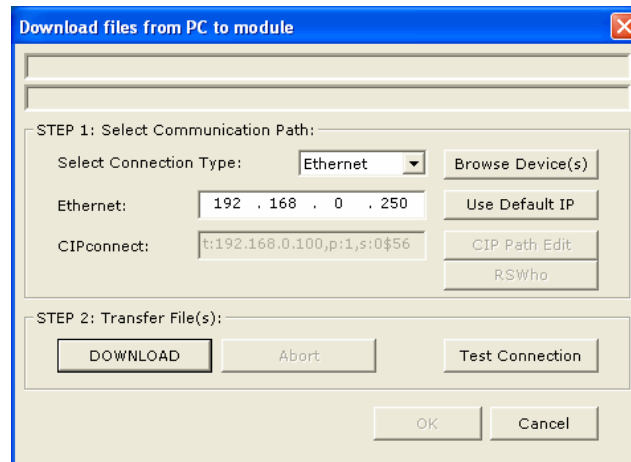

Click **TEST CONNECTION** to verify that the IP address allows access to the module.

- 3 If the connection succeeds, click **DOWNLOAD** to transfer the Ethernet configuration to the module.

If the *Test Connection* procedure fails, you will see an error message. To correct the error, follow these steps.

- 1 Click **OK** to dismiss the error message.
- 2 In the *Download* dialog box, click **BROWSE DEVICE(S)** to open *ProSoft Discovery Service*.

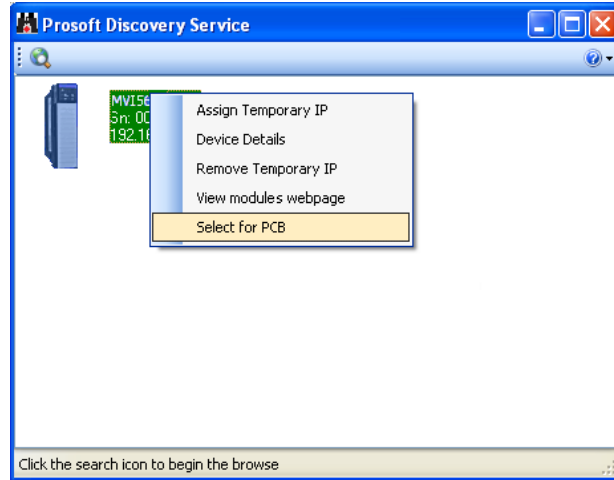

- 3 Select the module, and then click the right mouse button to open a shortcut menu. On the shortcut menu, choose **SELECT FOR PCB**.
- 4 Close *ProSoft Discovery Service*.
- 5 Click **DOWNLOAD** to transfer the configuration to the module.

4.8.1 Using CIPconnect to Connect to the Module

You can use CIPconnect® to connect a PC to the MVI56E-MNETC module over Ethernet using Rockwell Automation's 1756-ENBT EtherNet/IP® module. This allows you to configure the MVI56E-MNETC module and network, upload and download files, and view network and module diagnostics from a PC. RSLinx is not required when you use CIPconnect. All you need are:

- The IP addresses and slot numbers of any 1756-ENBT modules in the path
- The ControlNet node numbers and slot numbers of any 1756-CNBx ControlNet Bridge modules in the path
- The slot number of the MVI56E-MNETC in the destination ControlLogix chassis (the last ENBT/CNBx and chassis in the path).

To use CIPconnect, follow these steps.

- 1 In the *Select Connection Type* dropdown list, choose **1756-ENBT**. The default path appears in the text box, as shown in the following illustration.

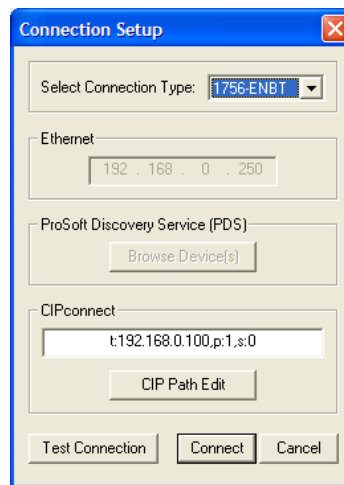

2 Click **CIP PATH EDIT** to open the *CIPconnect Path Editor* dialog box.

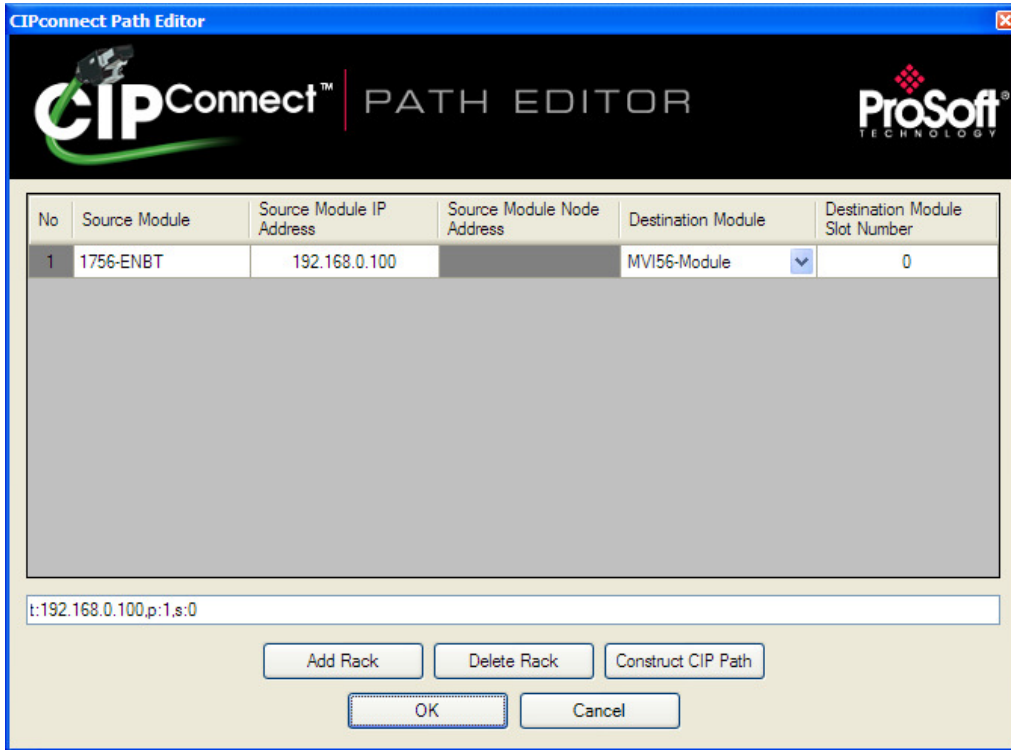

The *CIPconnect Path Editor* allows you to define the path between the PC and the MVI56E-MNETC module. The first connection from the PC is always a 1756-ENBT (Ethernet/IP) module.

Each row corresponds to a physical rack in the CIP path.

- If the MVI56E-MNETC module is located in the same rack as the first 1756-ENBT module, select **RACK No. 1** and configure the associated parameters.
- If the MVI56E-MNETC is available in a remote rack (accessible through ControlNet or Ethernet/IP), include all racks (by using the **ADD RACK** button).

Parameter	Description
Source Module	Source module type. This field is automatically selected depending on the destination module of the last rack (1756-CNB or 1756-ENBT).
Source Module IP Address	IP address of the source module (only applicable for 1756-ENBT)
Source Module Node Address	Node address of the source module (only applicable for 1756-CNB)
Destination Module	Select the destination module associated to the source module in the rack. The connection between the source and destination modules is performed through the backplane.
Destination Module Slot Number	The slot number where the destination MVI56E module is located.

To use the CIPconnect Path Editor, follow these steps.

- 1 Configure the path between the 1756-ENBT connected to your PC and the MVI56E-MNETC module.
 - If the module is located in a remote rack, add more racks to configure the full path.
 - The path can only contain ControlNet or Ethernet/IP networks.
 - The maximum number of supported racks is six.
- 2 Click **CONSTRUCT CIP PATH** to build the path in text format
- 3 Click **OK** to confirm the configured path.

4.8.2 Using RSWho to Connect to the Module

You need to have RSLinx installed on your PC to use this feature. You also need an ENBT module set up in the rack. For information on setting up the ENBT module, see Using CIPconnect to Connect to the Module (page 49).

- 1 In the tree view in *ProSoft Configuration Builder*, right-click the **MVI56E-MNETC** module.
- 2 From the shortcut menu, choose **DOWNLOAD FROM PC TO DEVICE**.
- 3 In the *Download* dialog box, choose **1756 ENBT** from the *Select Connection Type* dropdown box.

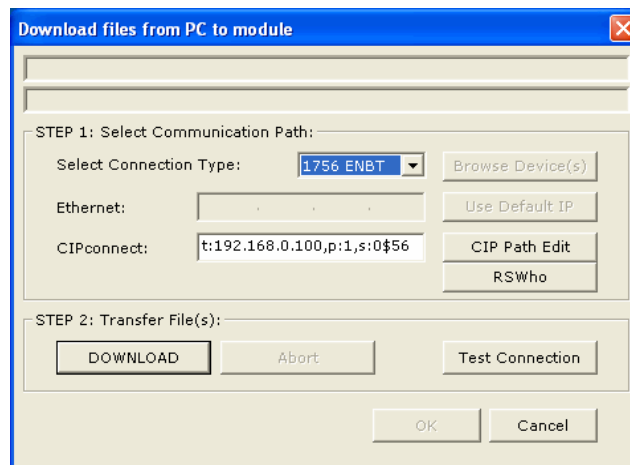

- 4 Click **RSWHO** to display modules on the network. The MVI56E-MNETC module will automatically be identified on the network.

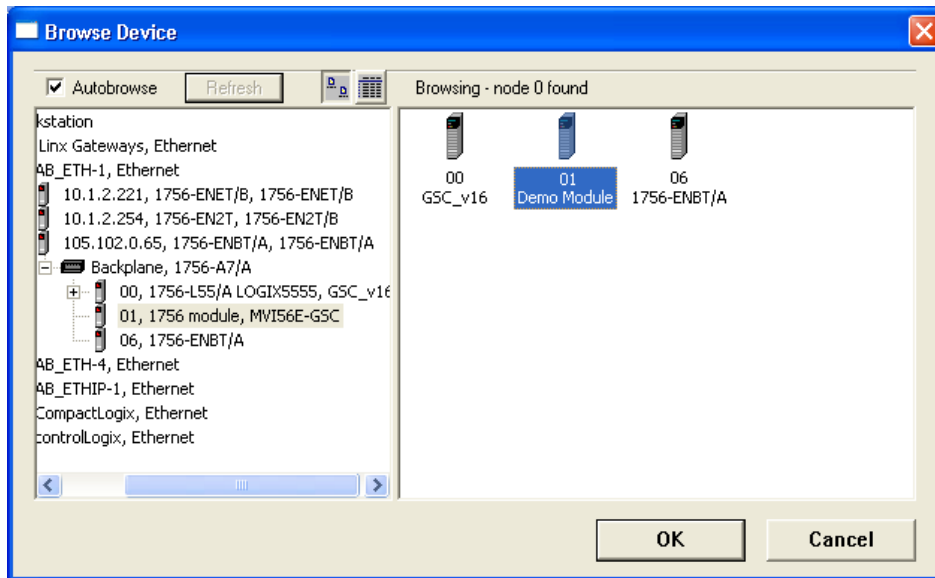

- 5 Select the module, and then click **OK**.
- 6 In the *Download* dialog box, click **DOWNLOAD**.

4.9 Configuring the NOE Ethernet adapter for Modbus TCP/IP (Server)

The next part of this tutorial is to configure the remote Modbus TCP/IP Server. For this example, the Modbus TCP/IP Server will be a NOE communication adapter.

The IP Address for the Modbus TCP/IP Server must match the IP Address settings for the MNET Client 0 Commands in ProSoft Configuration Builder.

The following illustration shows the **ETHERNET / I/O SCANNER** dialog box with the NOE card configured as a Modbus TCP/IP Server in Concept version 2.6.

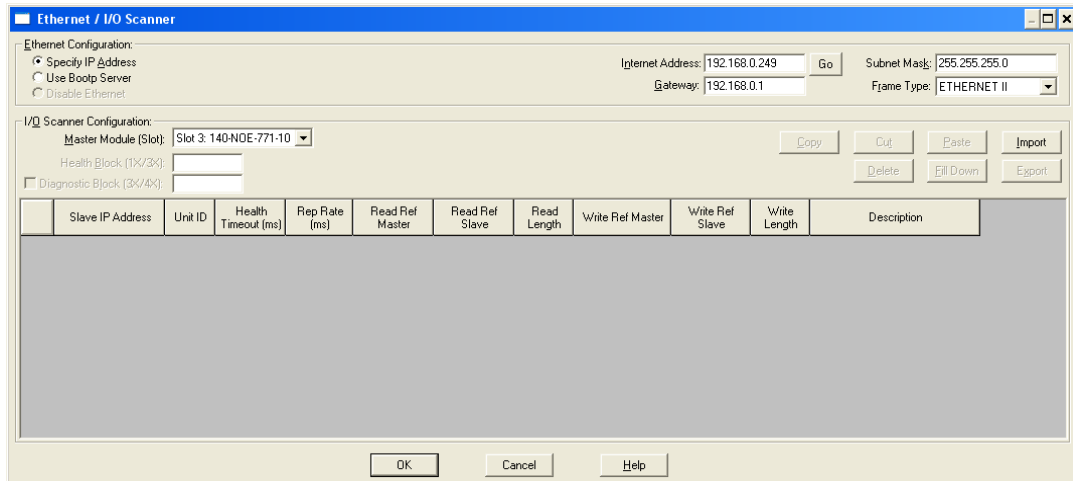

4.10 Connecting the MVI56E-MNETC Module to the Modbus TCP/IP Server

The final part of this tutorial is to connect the supplied Ethernet cable to the Ethernet Application Port on the MVI56E-MNETC module either directly, or through an Ethernet hub or switch, to the Ethernet port on an NOE card in the same rack with the Quantum processor.

The following illustration shows the Ethernet connection between the MVI56E-MNETC module and the Quantum processor.

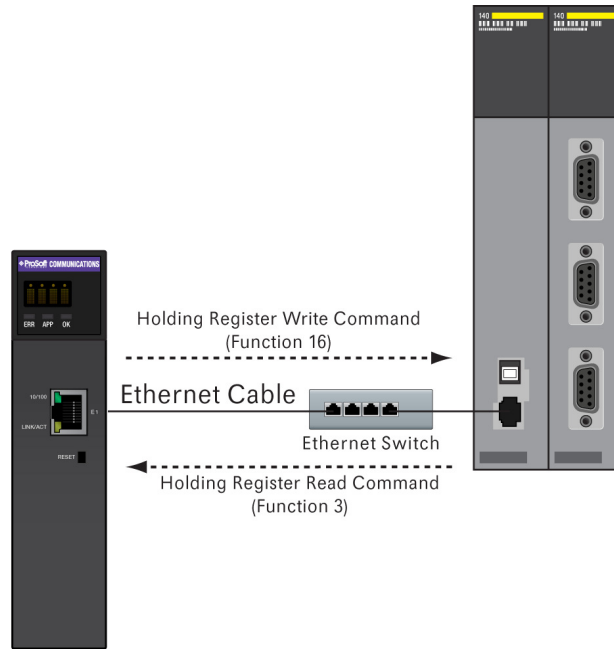

4.11 Verifying Communication

There are several ways to verify that the MVI56E-MNETC module is communicating with the processor and with the Modbus TCP/IP Client network. You can:

- View Exchanged Data
- View the Module Status in the RSLogix 5000 Controller Tags
- View the LED Status Indicators

4.11.1 Viewing Exchanged Data

The following illustration describes the source and destination for the data exchanged by the two Modbus TCP/IP Client Commands.

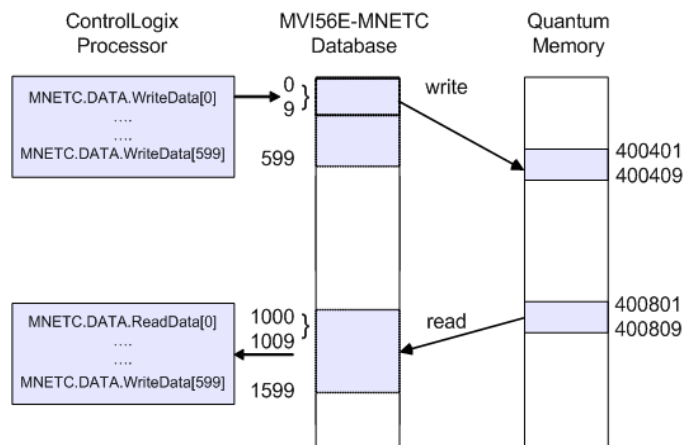

Checking Write Data

The following steps show you how to verify that the WriteData Command is working.

- 1 In RSLogix, navigate to the processor controller tags **MNETC.DATA.WRITEDATA[0]** through **MNETC.DATA.WRITEDATA[9]**.
- 2 For words **[0]** through **[9]**, enter the numbers shown in the following illustration.

[-] MNETC.DATA.WriteData	[...]
[+] MNETC.DATA.WriteData[0]	1
[+] MNETC.DATA.WriteData[1]	2
[+] MNETC.DATA.WriteData[2]	3
[+] MNETC.DATA.WriteData[3]	4
[+] MNETC.DATA.WriteData[4]	5
[+] MNETC.DATA.WriteData[5]	6
[+] MNETC.DATA.WriteData[6]	7
[+] MNETC.DATA.WriteData[7]	8
[+] MNETC.DATA.WriteData[8]	9
[+] MNETC.DATA.WriteData[9]	10

This action sends the values you entered to the **MODBUS CLIENT 0** on the MVI56E-MNETC, and then to the Quantum processor, where you will be able to see the data in Concept.

- 3 In Concept, navigate to the **REFERENCE DATA EDITOR** to monitor the processor memory addresses from 400401 through 400410. The data should match the data you sent from RSLogix 5000.

RDE Template (untitled) - Animation ON				
	Variable Name	Data Type	Address	Value
1				
2			400401	1
3			400402	2
4			400403	3
5			400404	4
6			400405	5
7			400406	6
8			400407	7
9			400408	8
10			400409	9
11			400410	10

Checking Read Data

The following steps show you how to verify that the ReadData Command is working.

- 1 In Concept, navigate to the **REFERENCE DATA EDITOR**, and enter the following values in processor memory addresses from 400801 through 400810 as shown in the following illustration.

RDE Template (untitled) - Animation ON				
	Variable Name	Data Type	Address	Value
14				
15			400801	101
16			400802	102
17			400803	103
18			400804	104
19			400805	105
20			400806	106
21			400807	107
22			400808	108
23			400809	109
24			400810	110

This action populates the memory addresses in the Quantum processor that the MVI56E-MNETC will attempt to retrieve with the ReadData Command.

- 2 In RSLogix 5000, the values in **MNETC.DATA.READDATA[0]** through **[9]** should match the data you entered in Concept.

- MNETC.DATA.ReadData	{...}
+ MNETC.DATA.ReadData[0]	101
+ MNETC.DATA.ReadData[1]	102
+ MNETC.DATA.ReadData[2]	103
+ MNETC.DATA.ReadData[3]	104
+ MNETC.DATA.ReadData[4]	105
+ MNETC.DATA.ReadData[5]	106
+ MNETC.DATA.ReadData[6]	107
+ MNETC.DATA.ReadData[7]	108
+ MNETC.DATA.ReadData[8]	109
+ MNETC.DATA.ReadData[9]	110

Tip: Repeat these tests, using different values each time, to verify that the same data appears in the proper place in each processor.

4.11.2 Checking Module Status through ControlLogix Controller Tags

You can view network status through the ControlLogix controller tags that are updated through the MVI56E-MNETC sample ladder.

To verify that the Modbus TCP/IP Client is communicating with one or more Modbus TCP/IP Servers, view the contents of the two ReadData array elements beginning at the address you used for the **COMMAND ERROR POINTER** parameter, minus the value of the **READ REGISTER START** parameter.

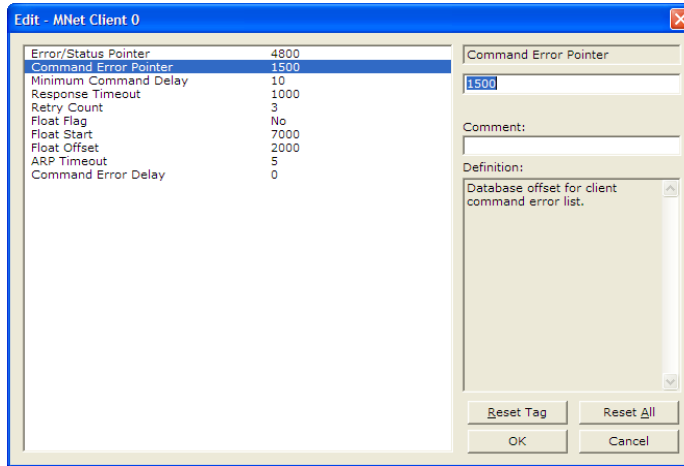

In this case, the **COMMAND ERROR POINTER** was set to 1500 and the **READ REGISTER START** to 1000. This means that $(1500 - 1000 = 500)$; so **READDATA[500]** and **READDATA[501]** will tell you the individual status of each of the two commands issued by the module.

To verify that the Modbus TCP/IP Server is communicating with a Modbus TCP/IP Client, view the contents of the **MNETC.STATUS.CLIENTSTATUS[0]** tag for total commands issued, responses received, errors, and so on.

-	MNETC.STATUS.ClientStatus[0]	{...}
+	MNETC.STATUS.ClientStatus[0].CmdReq	21772
+	MNETC.STATUS.ClientStatus[0].CmdResp	31859
+	MNETC.STATUS.ClientStatus[0].CmdErr	1
+	MNETC.STATUS.ClientStatus[0].Requests	21772
+	MNETC.STATUS.ClientStatus[0].Responses	31859
+	MNETC.STATUS.ClientStatus[0].ErrSent	0
+	MNETC.STATUS.ClientStatus[0].ErrRec	0
+	MNETC.STATUS.ClientStatus[0].CmErrWord	0
+	MNETC.STATUS.ClientStatus[0].CmErr	0
+	MNETC.STATUS.ClientStatus[0].LastErr	-48

The following controller tags should increment periodically, indicating that the Modbus TCP/IP Client is continuously sending commands and receiving responses:

- **MNETC.STATUS.CLIENTSTATUS[0].CMDREQ**
- **MNETC.STATUS.CLIENTSTATUS[0].CMDRESP**
- **MNETC.STATUS.CLIENTSTATUS[0].REQUESTS**
- **MNETC.STATUS.CLIENTSTATUS[0].RESPONSES**

If the error counters continuously increment, the **LASTERROR** controller tag value shows the command index that caused the latest failure.

+	MNETC.STATUS.ClientStatus[]CurErr	0
+	MNETC.STATUS.ClientStatus[]LastErr	0

4.11.3 LED Status Indicators

Scrolling LED Status Indicators

The scrolling LED display indicates the module's operating status as follows:

Initialization Messages

Code	Message
Boot / DDOK	Module is initializing
Ladd	Module is waiting for required module configuration data from ladder logic to configure the application port(s)
Waiting for Processor Connection	Module did not connect to processor during initialization <ul style="list-style-type: none"> ▪ Sample ladder logic or AOI is not loaded on processor ▪ Module is located in a different slot than the one configured in the ladder logic/AOI ▪ Processor is not in RUN or REM RUN mode
Last config: <date>	Indicates the last date when the module changed its IP address. You can update the module date and time through the module's web page, or with the Optional MVI56E Add-On Instruction.
	After power up and every reconfiguration, the module will display the configuration of the application port(s). The information consists of: Client <ul style="list-style-type: none"> ▪ C0 C2 C3 C4 C29

Operation Messages

After the initialization step, the following message pattern will be repeated.

<Backplane Status> <IP Address> <Backplane Status> <Port Status>

Code	Message
<Backplane Status>	OK: Module is communicating with processor ERR: Module is unable to communicate with processor. For this scenario, the <Port Status> message above is replaced with "Processor faulted or is in program mode".
<IP Address>	Module IP address
<C0>	OK: Port is communicating without error Communication Errors: port is having communication errors. Refer to PCB diagnostics for further information about the error.

Ethernet LED Indicators

The Ethernet LEDs indicate the module's Ethernet port status as follows:

LED	State	Description
Data	OFF	Ethernet connected at 10Mbps duplex speed
	AMBER Solid	Ethernet connected at 100Mbps duplex speed
Link	OFF	No physical network connection is detected. No Ethernet communication is possible. Check wiring and cables.
	GREEN Solid or Blinking	Physical network connection detected. This LED must be ON solid for Ethernet communication to be possible.

Non-Scrolling LED Status Indicators

The non-scrolling LEDs indicate the module's operating status as follows:

LED Label	Color	Status	Indication
APP	Red or Green	OFF	The module is not receiving adequate power or is not securely plugged into the rack. May also be OFF during configuration download.
		GREEN	The MVI56E-MNETC is working normally.
		RED	The most common cause is that the module has detected a communication error during operation of an application port. The following conditions may also cause a RED LED: <ul style="list-style-type: none"> ▪ The firmware is initializing during startup ▪ The firmware detects an on-board hardware problem during startup ▪ Failure of application port hardware during startup ▪ The module is shutting down ▪ The module is rebooting due to a ColdBoot or WarmBoot request from the ladder logic or Debug Menu
OK	Red or Green	OFF	The module is not receiving adequate power or is not securely plugged into the rack.
		GREEN	The module is operating normally.
		RED	The module has detected an internal error or is being initialized. If the LED remains RED for over 10 seconds, the module is not working. Remove it from the rack and re-insert it to restart its internal program.
ERR	Red	OFF	The battery voltage is OK and functioning.
		ON	The battery voltage is low or battery is not present. Allow battery to charge by keeping module plugged into rack for 24 hours. If ERR LED still does not go off, contact ProSoft Technology, as the battery is not a user-serviceable item.

5 Building on Success

In This Chapter

- ❖ Frequently Asked Questions 62

Now that you have successfully installed, configured, and verified operation of the MVI56E-MNETC module, you should have a better understanding of how to make it work for your specific application. The following resources are available to help you build on your success.

- For more information about the MVI56E-MNETC module, including detailed hardware and software configuration, troubleshooting, and application information, refer to the *MVI56E-MNETC User Manual*.
- For technical support and warranty information for your MVI56E-MNETC module, refer to *Support, Service, and Warranty* in the *MVI56E-MNETC User Manual*.
- For more information on ProSoft Technology products and services, please visit www.prosoft-technology.com.

5.1 Frequently Asked Questions

5.1.1 *What are the differences between the MVI56 and the MVI56E modules? What does the "E" stand for?*

The "E" stands for **E**nhanced with **E**thernet communication capabilities. The new enhancements are:

- **PCB:** ProSoft Configuration Builder software; a Windows-based configuration utility providing a graphical user interface for module diagnostics with screen navigation, improving interoperability with the module.
- **Seamless Migration:** MVI56E products are backward compatible with existing ladder logic and module configuration files, allowing for a smooth transition when upgrading MVI56 products.
- **Personality Module:** The MVI56E incorporates a non-volatile CF (Industrial Compact Flash) memory card for storing the module's setup and network configuration data (or personality). This feature benefits the end-user with quick replacement of modules for disaster recovery. Restore a module by a simple exchange of the Personality Module with absolutely no PC or configuration requirements.
- **Ethernet Configuration port:** Allows for remote module connectivity. Replaces the serial communication port, becoming the primary configuration port with faster access.
- **LED Display:** The LED provides detailed, plain English diagnostics and error information for the module, backplane communication, and network conditions.
- **Discovery Service:** Allows PCB configuration software (or separate utility) to find and display products located on the network with key product attributes such as name, serial number, and IP address. The user will be able to change IP address, upload/download, and enter into diagnostics from the list.
- **CIPconnect[®]-enabled:** Allows end-users to use PCB from remote locations to local and remote chassis installed MVI56E module(s) through a 1756-ENxT. Multi hop (Ethernet and ControlNet™) connections are supported. RSLinx OEM is not required.

5.1.2 What is the difference between the MVI56E-MNET(R) and the MVI56E-MNETC(R)?

The MNETC and MNETCR modules support up to 30 Modbus TCP/IP Clients, while the MNET and MNETR modules support one Client.

- If your ControlLogix application needs to poll a large number of Modbus TCP/IP Server devices, and requires quick responses from these servers, you can divide the Servers among multiple Clients, and avoid timeouts if an individual Server does not respond to a Modbus TCP/IP command from a Client. The single Modbus TCP/IP Client in the MNET and MNETR modules must open and close connections to each server device they talk to, whereas the MNETC or MNETCR can have each client connect to its own server device and keep these connections open, thereby improving performance. The MNETC and MNETCR modules act as Modbus TCP/IP Clients only.
- If your application must respond to commands from another Modbus TCP/IP Client on the network, use the MNET or MNETR module. The MNET and MNETR modules can act as both a Modbus TCP/IP Server and as a Modbus TCP/IP Client

5.1.3 Is the MVI56E product a direct replacement to my existing MVI56 product?

Yes

5.1.4 How is the MVI56E-MNETC configured?

The module is configured using ProSoft Configuration Builder (PCB) software via the module's Ethernet port or through the backplane using CIPconnect[®]. The product no longer requires Windows HyperTerminal for configuration and does not come with a serial port.

5.1.5 What is ProSoft Configuration Builder (PCB)?

ProSoft Configuration Builder (PCB) provides a quick and easy way to manage module diagnostics and troubleshooting operations. Built-in module diagnostics menus and the serial port data stream analyzer can be accessed using PCB through the module's high-speed Ethernet configuration port (E1) or through Rockwell Automation 1756-ENxT or 1756-CNBx communications interfaces using CIPconnect[®].

5.1.6 What is the purpose of the MVI56E-MNETC Ethernet (E1) Port?

The Ethernet port (E1) is the application port as well as the configuration port and allows a remote PC to upload and download configuration files and monitor the module operation through ProSoft Configuration Builder (PCB).

5.1.7 How do I change the module's IP address?

- 1 Use ProSoft Discovery Service to temporarily change a MVI56E module's configuration port IP address.
- 2 Use ProSoft Configuration Builder to edit and download the Ethernet configuration to the module.
- 3 Use the Optional Add-On Instruction (AOI). The AOI file is available on the *ProSoft Solutions CD-ROM*, or can be downloaded from www.prosoft-technology.com.

5.1.8 What is the purpose of the Optional MVI56E-MNETC Add-On Instruction?

The Optional Add-On Instruction (AOI) allows the processor to perform the following tasks:

- 1 Set the MVI56E Ethernet settings
- 2 Read the MVI56E Ethernet settings
- 3 Set MVI56E date/time information
- 4 Read the MVI56E date/time information

Items 1 and 2 can also be performed through ProSoft Configuration Builder (PCB) for permanent IP address changes or through ProSoft Discovery Service for temporary changes. Items 3 and 4 can also be performed through the module's built-in web page.

The Optional AOI is needed only for specific applications where Ethernet or CIPconnect access from a programmer's personal computer (PC) to the module is not possible.

5.1.9 What is ProSoft Discovery Service (PDS)?

ProSoft Discovery Service (PDS) is Windows-based software that connects to the Ethernet port of the module for the following purposes:

- Automatic module discovery on the Ethernet network
- Set a temporary IP address for the module for easy commissioning
- Allow PCB to select the module for monitoring and IP address reconfiguration

The ProSoft Discovery Service software is supplied as a stand-alone utility, as well as being integrated into PCB.

5.1.10 Does the MVI56E-MNETC module require processor logic?

Yes, ladder logic is required for data transfer between the MVI56E module and the ControlLogix[®] processor.

- For RSLogix[™] 5000 version 16 applications (or later), the included Add-On Instruction encapsulates the entire ladder logic into one single instruction.
- For RSLogix 5000 version 15 and older, sample ladder logic is available from the ProSoft Technology[®] website at www.prosoft-technology.com.

5.1.11 How do I monitor MVI56E-MNETC operation?

Module operation can be monitored either through the processor controller tags or through the ProSoft Configuration Builder diagnostic window. Available status information includes number of messages sent, number of messages received, number of errors, and error codes.

5.1.12 Are there any other ways to monitor module diagnostics besides being connected to the module's network (subnet)?

PCB can monitor the module via ControlLogix backplanes and process networks using CIPconnect. The PC running PCB can use its Ethernet port to connect to any 1756-ENxT EtherNet/IP™ interface module which is on the same Ethernet subnet. Through this connection, PCB can use CIPconnect to route through the ControlLogix backplane to other 1756-ENxT or 1756-CNBx modules, for up to five more route links, to reach an MVI56E module in a chassis connected on EtherNet/IP or ControlNet™ process networks.

Glossary of Terms

A

ASCII

American Standard Code for Information Interchange. A communication mode in which each eight-bit byte in a message contains one ASCII character code. ASCII characters (or hexadecimal characters) are sometimes used as a key to encrypt data and ensure its secure transmission.

C

Client

A client is a software program, or the device on which that program runs, that makes requests for information from a software program, or the device on which that program runs, in a client-server relationship.

A Client on an Ethernet network is equivalent to a Master on a serial network.

D

Default Gateway

The IP address of a network router where data is sent if the destination IP address is outside the local subnet. The gateway is the device that routes the traffic from the local area network to other networks such as the Internet.

E

ESD

Electrostatic Discharge. Can cause internal circuit damage to the coprocessor.

Ethernet

A set of network cabling and network access (CSMA/CD) protocol standards for bus topology computer networks invented by Xerox but now controlled by the 802.3 subcommittee of the IEEE.

F

Firmware

Software for embedded computers.

Full-Duplex

A communications circuit or system designed to simultaneously transmit and receive two different streams of data. Telephones are an example of a full-duplex communication system. Both parties on a telephone conversation can talk and listen at the same time. If both talk at the same time, their two signals are not corrupted.

H

Half-Duplex

A communications circuit or system designed to transmit and receive data, but not both simultaneously. Citizens' Band (CB) or walkie-talkie radios are an example of a half-duplex communication system. Either party to a radio conversation may talk or listen; but both cannot talk at the same time without corrupting each other's signal. If one operator is "talking", the other must be "listening" to have successful communication.

I

IP Address

A 32-bit identification number for each node on an Internet Protocol network. These addresses are represented as four sets of 8-bit numbers (numbers from 0 to 255), separated by periods ("dots").

Networks using the TCP/IP Protocol route messages based on the IP address of the destination. Each number can be 0 to 255. For example, 192.168.0.100 could be an IP address. Each node on the network must have a unique IP address.

L

LED

Light-emitting diode.

M

MAC ID

A hexadecimal number that uniquely identifies an Ethernet device. This MAC ID number is encoded onto the hardware by the manufacturer at the time the device is made and may not be changed.

Master

A Master is a program or device that initiates all requests for information from other programs or the devices on a network, known as a Slaves, in a Master-Slave communication model.

A Client on an Ethernet network is equivalent to a Master on a Serial network.

N

Network

A series of stations or nodes connected by some type of communication medium. A network may consist of a single link or multiple links.

Node

An address or software location on the network.

P

Peer-to-Peer

A network relationship between devices where each device can send commands as a master or client, and respond to commands as a slave or server.

Power Supply

Device that supplies electrical power to the I/O chassis containing the processor, coprocessor, or other modules.

Protocol

The language or packaging of information that is transmitted between nodes on a network.

S

Server

A Server is a software program, or the device on which that program runs, that provides a specific kind of service to a Client software program, or the device on which that program runs, on an Ethernet network.

A Server on an Ethernet network is equivalent to a Slave on a Serial network.

Simplex

A communications circuit or system designed to either transmit data or receive data, but not both. Broadcast television is an example of simplex communication system. A television station sends a TV signal but cannot receive responses back from the television sets to which it is transmitting. The TV sets can receive the signal from the TV station but cannot transmit back to the station.

Slave

A Slave is a software program, or the device on which that program runs, which provides a specific kind of service to a Master software program, or the device on which that program runs, on a serial network.

A Slave on a Serial network is equivalent to a Server on an Ethernet network.

Subnet Mask

A mask used to determine what subnet an IP address belongs to. An IP address has two components: the network address, and the host (node or device) address. For example, consider the IP address 150.215.017.009. Assuming this is part of a Class B network (with a subnet mask of 255.255.0.0), the first two numbers (150.215) represent the Class B network address, and the second two numbers (017.009) identify a particular host on this network.

Index

A

About the MODBUS TCP/IP Protocol • 18
Architecture • 20
Are there any other ways to monitor module diagnostics besides being connected to the module's network (subnet)? • 65
ASCII • 67

B

Battery Life Advisory • 4
Before You Begin • 13
Building on Success • 61

C

Checking Module Status through ControlLogix Controller Tags • 58
Checking Read Data • 57
Checking Write Data • 56
Client • 67
Configuring the Modbus Client Read Command • 19, 41
Configuring the Modbus Client Write Command • 19, 42
Configuring the NOE Ethernet adapter for Modbus TCP/IP (Server) • 19, 53
Connecting the MVI56E-MNETC Module to the Modbus TCP/IP Server • 54
Connecting Your PC to the ControlLogix Processor • 19, 33
Connecting Your PC to the Module • 43
Creating a New RSLogix 5000 Project • 19, 27
Creating the Module • 28

D

Default Gateway • 67
Does the MVI56E-MNETC module require processor logic? • 64
Downloading the Project to the Module • 19, 47
Downloading the Sample Program to the Processor • 9, 19, 34

E

Enabling the MNET Client 0 Commands • 9, 40
ESD • 67
Ethernet • 67
Ethernet LED Indicators • 60

F

Firmware • 67
Frequently Asked Questions • 62
Full-Duplex • 67

G

General Overview • 19

H

Half-Duplex • 68
How do I change the module's IP address? • 64
How do I monitor MVI56E-MNETC operation? • 65
How is the MVI56E-MNETC configured? • 63
How to Contact Us • 2

I

Important Safety Information • 3
Importing the Add-On Instruction • 30
Installing ProSoft Configuration Builder • 35
Installing the Module in the Rack • 25
IP Address • 68
Is the MVI56E product a direct replacement to my existing MVI56 product? • 63

L

Learning Objectives • 9
LED • 68
LED Status Indicators • 59

M

MAC ID • 68
Master • 68
Memory Map • 21

N

Network • 68
Node • 68
Non-Scrolling LED Status Indicators • 60

P

Peer-to-Peer • 69
Power Supply • 69
Prerequisites • 11
Procedures • 23
ProSoft Technology Documentation • 10
ProSoft Technology® Product Documentation • 2
Protocol • 69

R

Required Items • 15
Required Steps • 19

S

Sample Files • 16
Scope • 7
Scrolling LED Status Indicators • 59
Server • 69
Setting Jumpers • 24
Setting Up a Temporary IP Address • 43
Setting Up the Project • 36
Simplex • 69

Slave • 69
Subnet Mask • 69
System Requirements • 14

T

The Sample Application • 9, 17

U

Uploading the Sample Configuration from the Module •
19, 38
Using CIPconnect to Connect to the Module • 47, 49,
51
Using ProSoft Configuration Builder Software • 35
Using RSWho to Connect to the Module • 47, 51

V

Verifying Communication • 9, 19, 55
Viewing Exchanged Data • 55

W

What are the differences between the MVI56 and the
MVI56E modules? What does the • 62
What is ProSoft Configuration Builder (PCB)? • 63
What is ProSoft Discovery Service (PDS)? • 64
What is the difference between the MVI56E-MNET(R)
and the MVI56E-MNETC(R)? • 63
What is the purpose of the MVI56E-MNETC Ethernet
(E1) Port? • 63
What is the purpose of the Optional MVI56E-MNETC
Add-On Instruction? • 64
What's New? • 8

Y

Your Feedback Please • 2