

# Operation Manual

Bently Nevada™ Asset Condition Monitoring

---

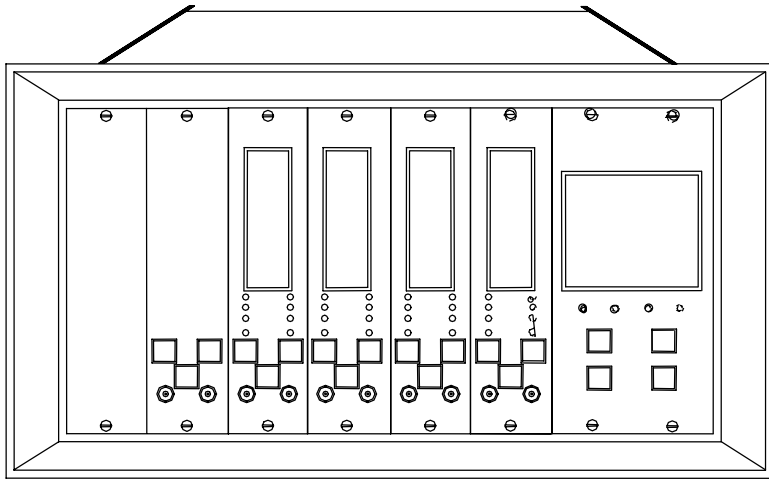

## 3300/16 Dual Vibration Monitor



imagination at work

Part Number 86830-01  
Rev. P (08/07)

**Copyright 1990. Bently Nevada LLC.  
All rights reserved.**

The information contained in this document is subject to change without notice.

The following are trademarks of General Electric Company in the United States and other countries:

Actionable Information, Actionable Information to the Right People at the Right Time, ADRE, Because Better Machines Start With Better Bearings, Because the Right Results Require the Right Knowledge, Because You Depend on Your Machinery, Bently ALIGN, Bently BALANCE, Bently DOCUVIEW, Bently LUBE, Bently PERFORMANCE, Bently Nevada, CableLoc, ClickLoc, Data Manager, Decision Support, DemoNet, Dynamic Data Manager, Dynamic Transmitter, Engineer Assist, FieldMonitor, flexiTAM, flexiTAM, FluidLoc, Helping You Protect and Manage All Your Machinery, HydroVU, Key Ø, Keyphasor, Machine Condition Manager 2000, MachineLibrary, Machine Manager, MicroPROX, Move Data, Not People, Move Information, Not Data, NSV, Preformalign, Prime Spike, PROXPAC, Proximitor, REBAM, SE, Seismoprobe, ServoFluid, Smart Monitor, Snapshot, System 1, System Extender, TDXnet, TDIXconnX, Tecknowledgy, TipLoc, TorXimitor, Transient Data Manager, Trendmaster, TrimLoc, VAM, Velomitor, X Lerometer

## Contact Information

The following ways of contacting Bently Nevada are provided for those times when you cannot contact your local representative:

Mailing Address	1631 Bently Parkway South Minden, Nevada USA 89423 USA
Telephone	1.775.782.3611 1.800.227.5514
Fax	1.775.215.2873
Internet	<a href="http://www.ge-energy.com/bently">www.ge-energy.com/bently</a>

**Note:**

In this document procedures are given only for channel A. Procedures for channel B are similar except for the obvious substitutions of corresponding switches, terminals, and indicators.

---

# Additional Information

---

## Notice:

This manual does not contain all the information required to operate and maintain the product. Refer to the following manuals for other required information.

**3300 System Overview (Part Number 80171-01)**

**3300 System Installation Instructions (Part Number 80172-01)**

**3300 System Troubleshooting (Part Number 80173-01)**

**3300/12 AC Power Supply (Part Number 89602-01)**

**3300/14 DC Power Supply (Part Number 101256-01)**

**3300/03 System Monitor (Part Number 89604-01)**

**3300 Internal Barrier Manual (Part Number 88837-01)**

## RELATED PARTS

**3300/16 Field Wiring Diagram Packet (Part Number 100311-01)**

**3300/16 Data Sheet (Part Number 141498-01)**

**3300/16 Meter Scales (Part Number 84113-16)**

## Product Disposal Statement

Customers and third parties, who are not member states of the European Union, who are in control of the product at the end of its life or at the end of its use, are solely responsible for the proper disposal of the product. No person, firm, corporation, association or agency that is in control of product shall dispose of it in a manner that is in violation of any applicable federal, state, local or international law. Bently Nevada LLC is not responsible for the disposal of the product at the end of its life or at the end of its use.

## SYMBOLS

Special symbols are used in the manual to illustrate specifics in the step-by-step processes. For example:



Press

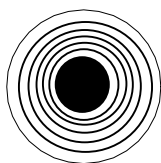

Flashing

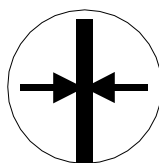

Connect

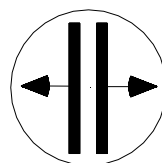

Disconnect

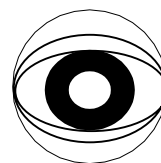

Observe

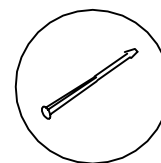

Screwdriver

# Contents

---

<b>1. Dual Vibration Monitoring System .....</b>	<b>1</b>
<b>2. Front Panel Features.....</b>	<b>2</b>
<b>3. Monitor Functions .....</b>	<b>3</b>
<b>4. Channel Vibration.....</b>	<b>6</b>
<b>5. LED Functionality.....</b>	<b>7</b>
5.1 OK LEDs.....	7
5.2 Bypass LEDs.....	8
5.3 Alert LEDs.....	9
5.4 Danger LEDs.....	10
<b>6. Read Gap Voltage .....</b>	<b>11</b>
<b>7. Read Setpoint Values .....</b>	<b>12</b>
7.1 Read Alert Setpoints.....	12
7.2 Read Danger Setpoints.....	13
<b>8. Monitor Removal .....</b>	<b>14</b>
<b>9. Monitor Disassembly .....</b>	<b>15</b>
9.1 Side Cover Removal .....	15
9.2 Front Panel Removal.....	16
9.3 Input Module .....	17
9.3.1 Input Module Removal.....	17
9.3.2 Dual Relay Module Options.....	18
9.3.3 Quad Relay Module Options.....	18
<b>10. Monitor Options .....</b>	<b>19</b>
<b>11. Meter Scale Replacement.....</b>	<b>21</b>
<b>12. Alarm Setpoint Adjustment.....</b>	<b>22</b>
12.1 Alert and Danger Setpoint Adjustment .....	22
12.2 Gap Alert Setpoint Adjustment.....	23
12.3 Channel B Adjust .....	23
<b>13. Channel Bypass.....</b>	<b>24</b>
<b>14. Danger Bypass .....</b>	<b>25</b>
<b>15. Test Alarms .....</b>	<b>26</b>
15.1 Test Equipment Setup .....	26

---

15.2	Test Channel Alarms .....	27
15.3	Test Gap Alarms.....	29
15.4	Channel B and Reinstallation.....	30
<b>16.</b>	<b>Test OK Limits .....</b>	<b>31</b>
16.1	Test Equipment Setup .....	31
16.2	Test Upper OK Limit.....	32
16.3	Test Lower OK Limit.....	32
16.4	Channel B and Reinstallation.....	33
<b>17.</b>	<b>Calibrate Channels .....</b>	<b>34</b>
17.1	Calibration Equipment Setup.....	34
17.2	Calibration Procedure .....	35
<b>18.</b>	<b>Zero Position Adjustment .....</b>	<b>37</b>
<b>19.</b>	<b>Self Test.....</b>	<b>39</b>
<b>20.</b>	<b>Error Codes.....</b>	<b>43</b>
<b>21.</b>	<b>Appendix A – Monitor Options for PWA 140720-01 .....</b>	<b>44</b>
21.1	Jumper Locations for PWA 140720-01 .....	44
21.2	Main Board Option Settings.....	45
21.3	Recorder Output Options.....	46
21.4	Gap Full Scale Range Options.....	46
21.5	Vibration Full Scale Range Options .....	47
21.6	Transducer Input Options.....	48
21.7	Trip Multiply.....	48
<b>22.</b>	<b>Appendix B - Monitor Options for PWA 135305-01 .....</b>	<b>50</b>
22.1	Jumper Locations for 135305-01 .....	50
22.2	Main Board Option Settings.....	51
22.3	Recorder Output Options.....	52
22.4	Gap Full Scale Range Options.....	52
22.5	Vibration Full Scale Range Options .....	53
22.6	Transducer Input Options.....	54
22.7	Trip Multiply.....	54
<b>23.</b>	<b>Appendix C – Monitor Options for PWA 86739-01 .....</b>	<b>56</b>
23.1	Jumper locations for 86739-01.....	56
23.2	Main Board Option Settings.....	57
23.3	Recorder Output Options.....	58
23.4	Gap Full Scale Range Options.....	58
23.5	Vibration Full Scale Range Options .....	59

---

- 23.6 Transducer Input Options.....59
- 23.7 Trip Multiply.....60
- 24. Recommended Spare Parts.....61**
- 25. Index.....63**

# 1. Dual Vibration Monitoring System

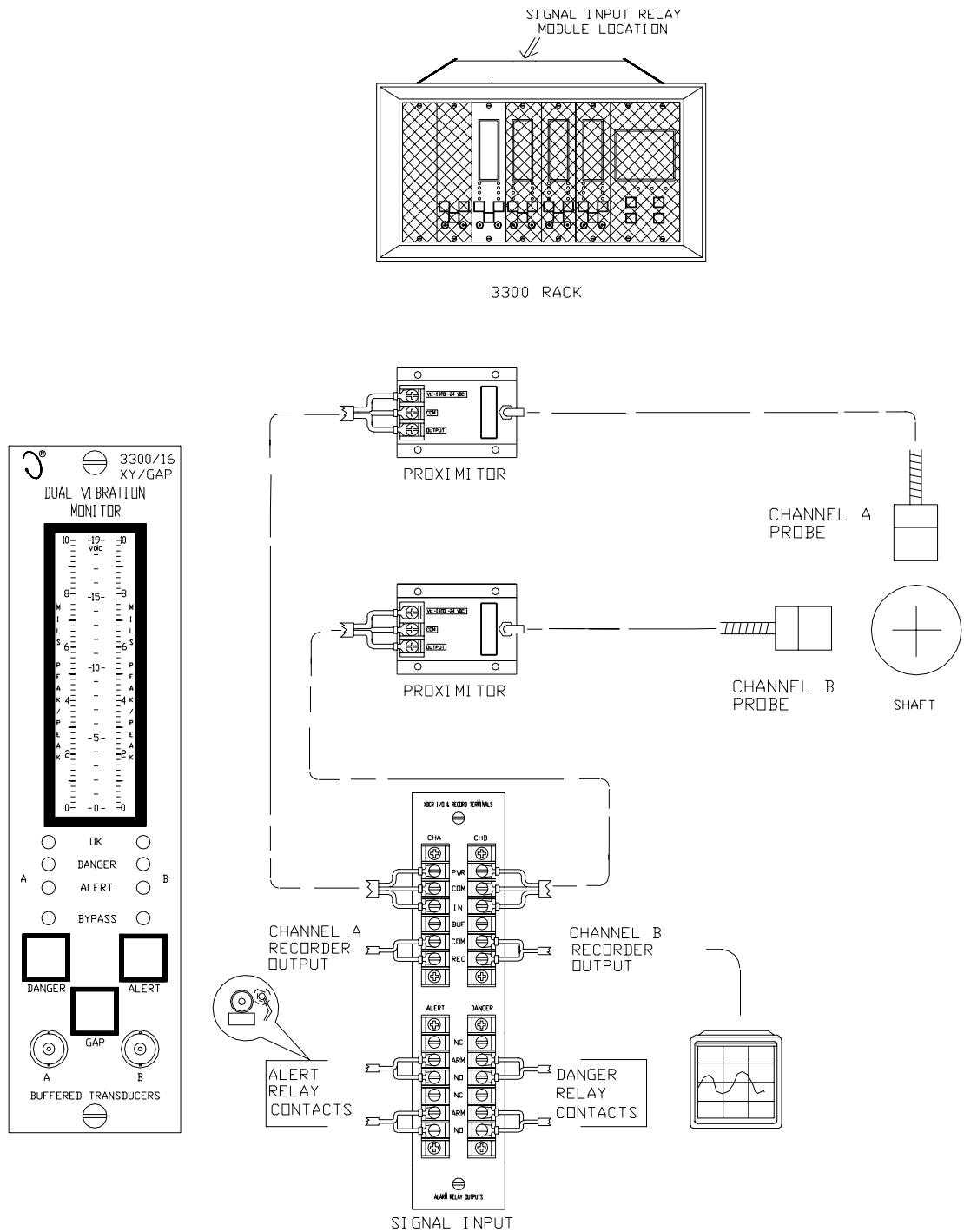

## 2. Front Panel Features

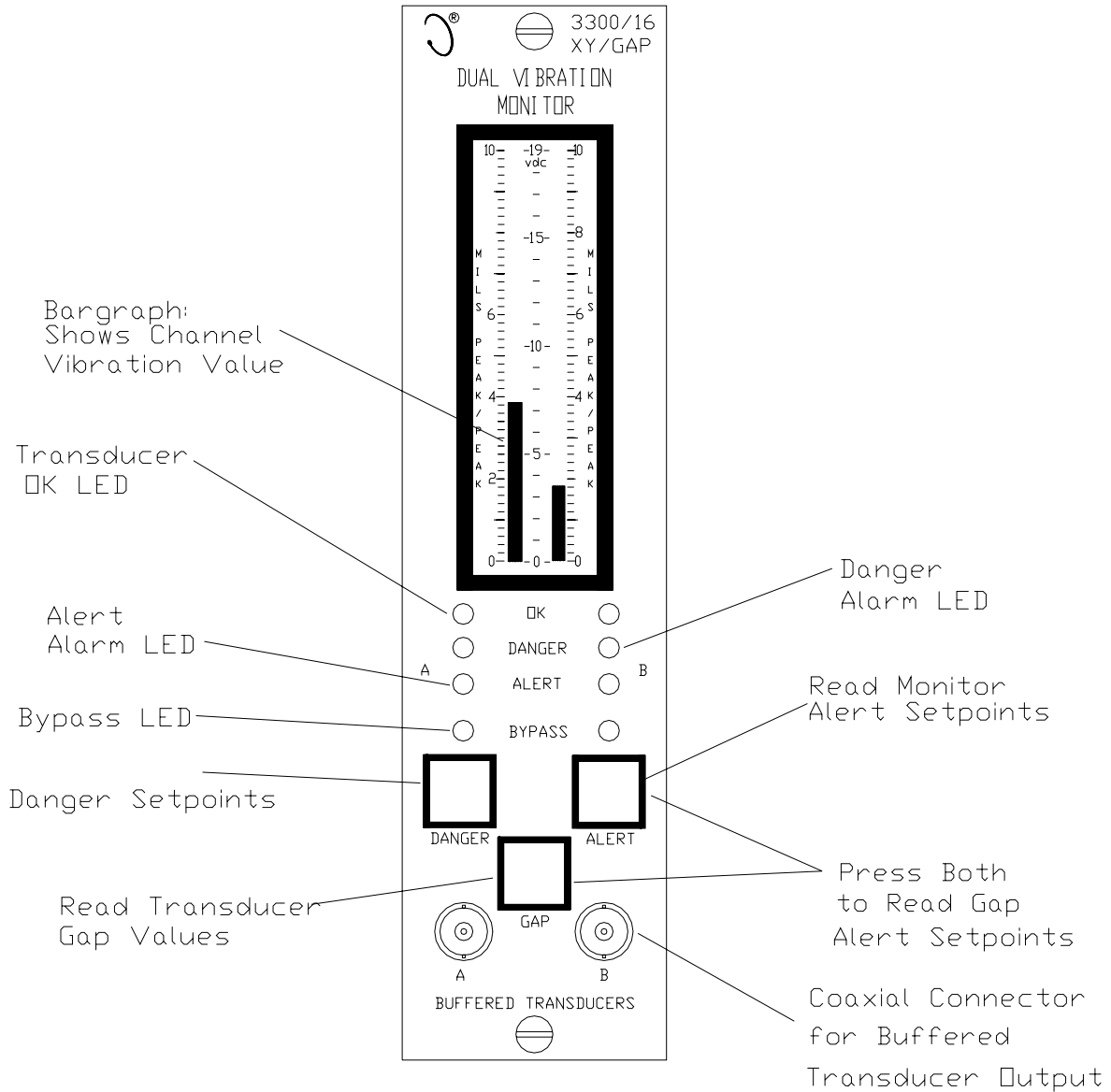



## 3. Monitor Functions

---

**RADIAL VIBRATION** - Radial vibration is defined as shaft dynamic motion in a direction perpendicular to the shaft centerline. The Dual Vibration Monitor displays values for two channels (Channel A and B).

**PROBE GAP VOLTAGE** - Probe gap is measured as a negative dc voltage that is directly proportional to the gap distance between the face of a proximity probe and the surface being monitored. Probe gap value for each channel is displayed on the front panel meter by pressing the GAP switch.

**OK** - When the Proximity output voltage is within its upper/lower limits, the transducer is defined as OK. The OK detection circuit controls the channel **OK** LED and the monitor relay drive to the system Relay.

**OK RELAY** - The OK Relay is located on the Power Input Module. Every channel in the rack must be OK or bypassed to energize the OK Relay.

**TIMED OK/CHANNEL DEFEAT** - Timed OK/Channel Defeat prevents faulty transducer wiring from causing false alarms. If the probe input signal level on a given channel is not within upper/lower OK limits, that channel **OK** LED goes off, the **BYPASS** LED goes on, the channel is disabled, and the OK Relay deenergizes. Once the channel input signal level is restored within the upper/lower OK limits for at least 30 seconds, the channel **OK** LED will start flashing at 1 Hertz (Hz) to indicate the OK state is restored, the **BYPASS** LED goes off, and monitoring is enabled. You must press the **RESET** switch on the front panel of the System Monitor to stop the **OK** LED from flashing (it will then remain on steadily). If the channel remains in the not OK state, set the Channel Bypass switch on the monitor circuit board to put the channel "out of service". You can then operate the monitor as a single-channel monitor, and the OK Relay will return to an OK state (energized). Without this feature, the OK Relay could not be reactivated. In the Timed OK/Channel Defeat and Channel Bypass modes, the recorder output is clamped to zero vibration value and the display is clamped to zero.

**VIBRATION ALARM** - Pressing the **ALERT** or **DANGER** switches on the front panel of the monitor displays the Alert (first-level alarm) or Danger (second-level alarm) vibration setpoints on the front panel meter. When the radial vibration signal level is equal to or exceeds preset Alert setpoints for the selected time delay, the **ALERT** LEDs come on and the appropriate Alert Alarm relay contacts are activated. When the radial vibration signal level exceeds preset Danger setpoints, the **DANGER** LEDs come on and the appropriate Danger alarm relay contacts are activated.

**GAP ALARM** - Pressing the GAP and **ALERT** switches simultaneously displays the Gap Alert setpoints. When the gap level is equal to or outside the over and under setpoint window limits for 6 seconds, the **ALERT** LEDs come on and the appropriate Alert Alarm relay contacts are activated.

**FIRST OUT** - Separate First Out circuits exist for the Alert and Danger alarms. A monitor with First Out option selected flashes a channel alarm LED if that channel was the first channel in the rack to go into alarm since the last rack power up or reset. Pressing the **RESET** switch on the System Monitor acknowledge the First Out.

**ALARMS RELAYS** - Monitor alarms can operate in a latching or nonlatching mode. In the nonlatching mode, the alarm resets automatically when the alarm no longer exists. In the latching mode, you must reset the alarm condition manually by pressing the RESET switch on the front panel of the System Monitor (or by closing external Reset contacts). The alarm will not reset if the alarm condition still exists.

**DANGER BYPASS** - When you maintain machinery, you can set a Danger Bypass switch on the monitor circuit board behind the front panel to inhibit the Danger relay drive. This function causes the BYPASS LEDs to come on, but other front panel functions are not affected. You can enable this switch by installing a jumper on the circuit board in the monitor.

**CHANNEL BYPASS** - If a channel remains not OK, you can set the Channel Bypass switch on the monitor circuit board to put the channel "out of service".

**ZERO POSITION** - A reference gap value that you can set when the Gap Full Scale Range is in engineering units (mils or micrometers). You can then read gap on the meter scale relative to this zero position on the center of the gap meter scale. Selecting a Gap Full Scale Range in engineering units increases gap resolution on the display because only a selected area within the transducer's OK limits is displayed.

**BUFFERED OUTPUT** - The coaxial cable connectors on the front panel of the monitor and the terminals on the Signal Input Relay Module provide buffered signals from the respective channel transducers. Use these connectors to attach external equipment to the monitor.

**TRIP MULTIPLY** - The Trip Multiply function multiplies setpoints by 2X or 3X in response to an external contact closure through terminals on the Power Input Module. The front panel meter and recorder outputs could saturate in this mode.

**RECORDER OUTPUTS** - The recorder output is proportional to the measured vibration signal over the monitor full-scale range. The output range is user selectable to be 0 to -10Vdc, +1 to +5Vdc, or +4 to +20 mA.

The recorder clamping option, available when the +4 to +20 mA recorder output is selected, allows the user to choose the recorder output level used to annunciate a transducer not OK condition. With this option, the recorder output will clamp to either +2 mA or +4 mA (user selectable) when a transducer is not OK.

**SELF-TEST** - The monitor has three categories of self-test: Power-up, Cyclic, and User-invoked.

Power-up self-test is performed automatically each time the monitor power is turned on. A series of basic tests and transducer OK tests are performed.

Cyclic self-test is performed automatically during monitor operation. Errors encountered during cyclic tests disable the monitor and flash the error code on the LCD bargraph. If the error is intermittent, the monitor will resume operating, but the error codes will be stored for retrieval during a User-invoked self test. Stored error codes are indicated by the **OK** LEDs flashing at 5 Hz provided that the channel is OK.

User-invoked self-test performs the Power-up self test and lets you read and clear error codes stored during cyclic tests. Stored errors are annunciated by flashing the **OK** LEDs at 5 Hz and displaying the error codes on the front panel LCD bargraph.

## 4. Channel Vibration

The monitor continuously indicates measured vibration for channels A and B.

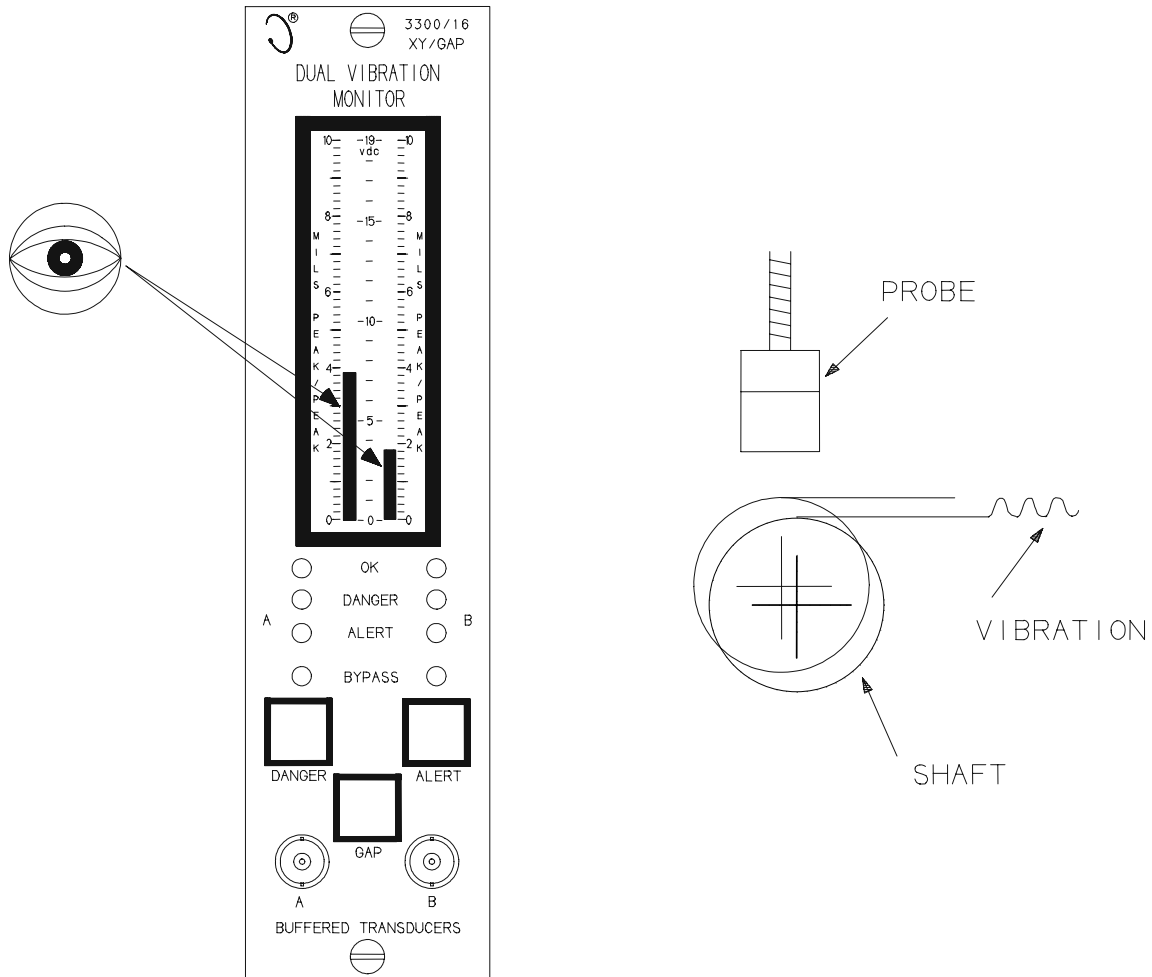

# 5. LED Functionality

## 5.1 OK LEDs

Note: Since each channel in the system controls the OK Relay, either channel can cause a Not OK Relay condition (deenergized relay).

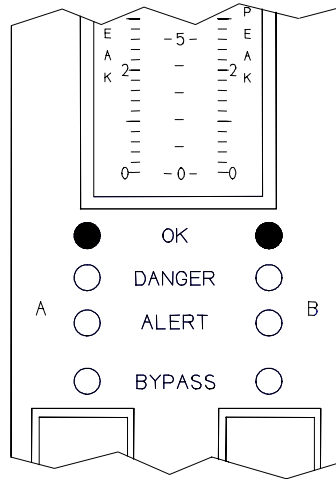

LED Display		Condition	OK Relay Drive
A	B		
● OK ●	Channel A and B in operating range.	ON	
● OK ○ ○ OK ●	Respective channel A or B transducer in Not OK condition or bypassed.	OFF	
○ OK ○	Monitor in self-test, or both transducers in Not OK condition or bypassed.	OFF	
⊙ OK ⊙	Flashing at 5 Hz means that an error was encountered during cyclic test. To read the error message, see section 19.	ON	
⊙ OK ⊙ ⊙ OK ● ● OK ⊙	Flashing at 1 Hz means that the transducer has been Not OK since the last reset.	ON	

## 5.2 Bypass LEDs

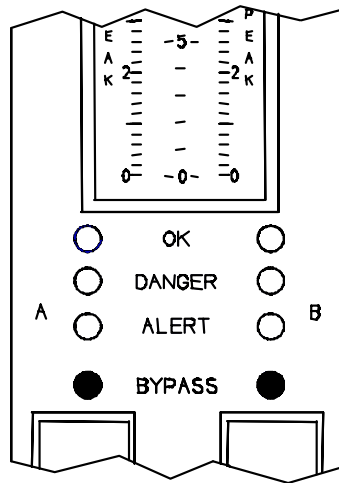

LED Display		Condition
A	B	
●	●	Monitor in Danger Bypass mode or System in Power-Up mode or User-invoked self-test in progress or Timed OK/Channel Defeat or both Channels bypassed or Monitor has detected an active error or Rack Inhibit Contacts at back of rack closed.
○	●	Channel A or B bypassed or Timed OK/Channel Defeat
●	○	
⊙	⊙	Trip Multiply activated Flashing overridden by: <ul style="list-style-type: none"> <li>• Timed OK/Channel Defeat or</li> <li>• Channel A or B bypassed</li> </ul>
●	⊙	
⊙	●	

### 5.3 Alert LEDs

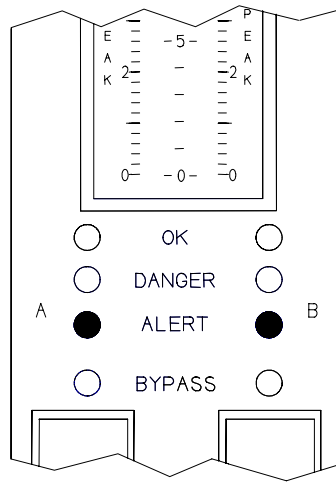

LED Display		Condition	Alert Relay Drive
A	B		
●	○	Vibration signal has exceeded the channel A alert level (see section 7.1).	ON
○	●	Vibration signal has exceeded the channel B alert level (see section 7.1).	ON
●	●	Vibration signal has exceeded the channel A and B alert level (see section 7.1).	ON
⊙	○	First out condition for vibration signal which has exceeded the channel A alert level.	ON
○	⊙	First out condition for vibration signal which has exceeded the channel B alert level.	ON

## 5.4 Danger LEDs

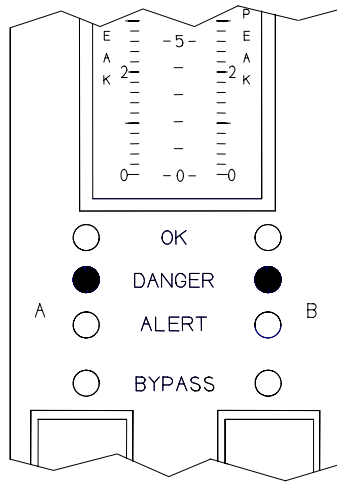

LED Display		Condition	Danger Relay Drive	
A	B		"or" voting	"and" voting
● DANGER	○	Vibration has exceeded the channel A danger level (see section 7.2).	ON	OFF
○ DANGER	●	Vibration has exceeded the channel B danger level (see section 7.2).	ON	OFF
● DANGER	●	Vibration has exceeded the channel A and channel B danger level (see section 7.2).	ON	ON
○ DANGER	◎	First out condition for vibration signal which has exceeded the channel B danger level.	ON	OFF
◎ DANGER	○	First out condition for vibration signal which has exceeded the channel A danger level.	ON	OFF



## 6. Read Gap Voltage

Press the **GAP** switch to read the Gap values for both channel A and B using the center meter scale.

For example, this monitor is indicating a Gap voltage of 6 Vdc for channel A and 3 Vdc for channel B. with 0 -19 Vdc Gap full scale option, Gap is displayed from the bottom scale zero as shown below.

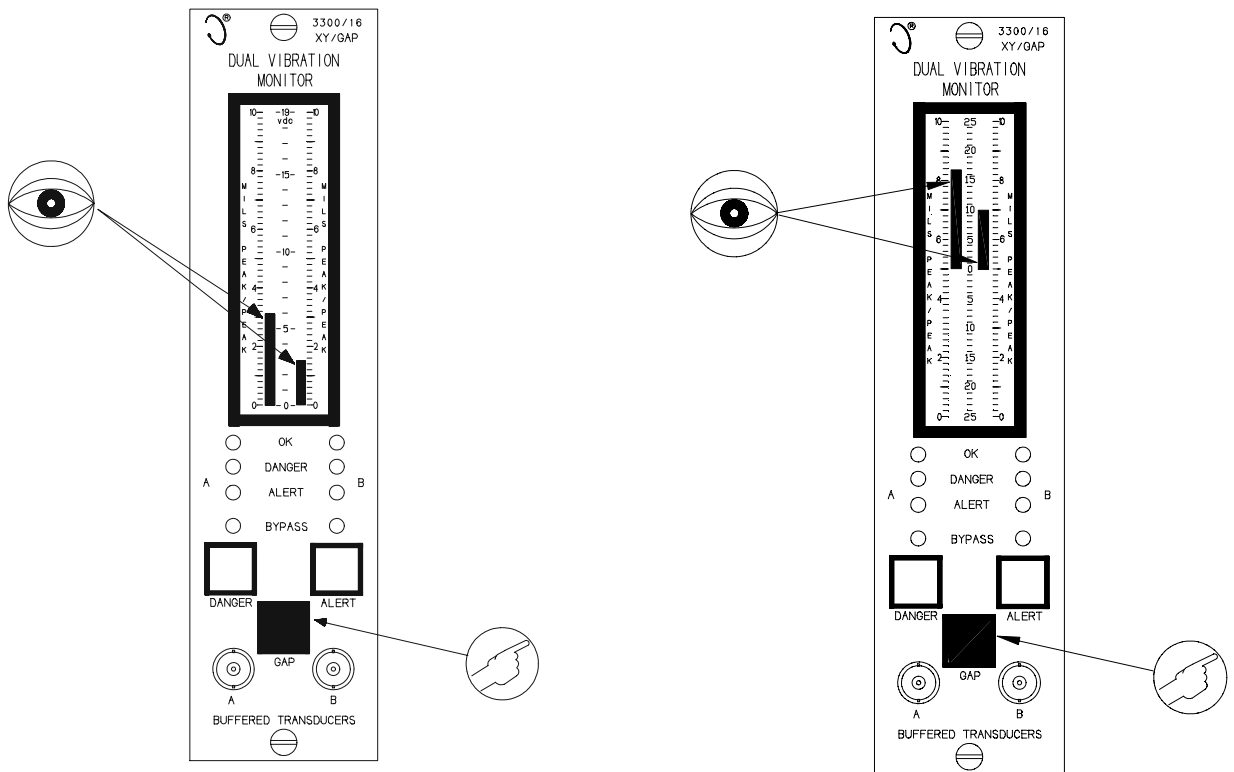

For all other Gap full scales, Gap is displayed from the center as shown below.

For example, this monitor is indicating a Gap value of 16 mil toward for channel A and 10 mil toward for channel B.

# 7. Read Setpoint Values

## 7.1 Read Alert Setpoints

Press the **ALERT** switch to read the Alert setpoint for both channel A and B on the meter scale.

This monitor shows Alert setpoints of the 6.0 mil for channel A and 5.2 mil for channel B.

Press the **GAP** and **ALERT** switches simultaneously to read the Gap Alert setpoint windows for both channel A and B on the meter scale using the center scale.

This monitor shows over and under Alert setpoints of 18 mil toward and 9 mil away for channel A and 15 mil toward and 5 mil away from channel B.

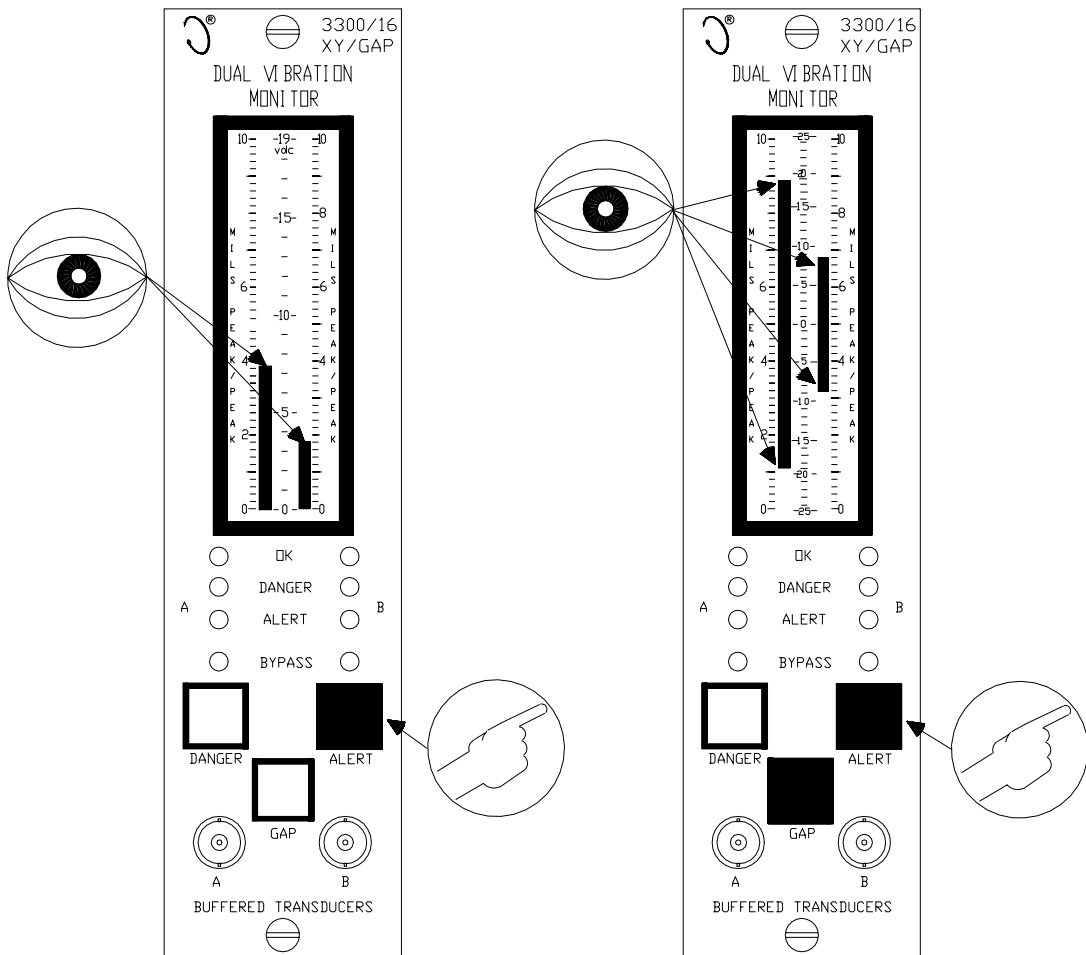

## 7.2 Read Danger Setpoints

Press the **DANGER** switch to read the Danger setpoints for both channel A and B on the meter scale.

This monitor shows a Danger setpoint of 7.6 mil for channel A and 6.2 mil for channel B.

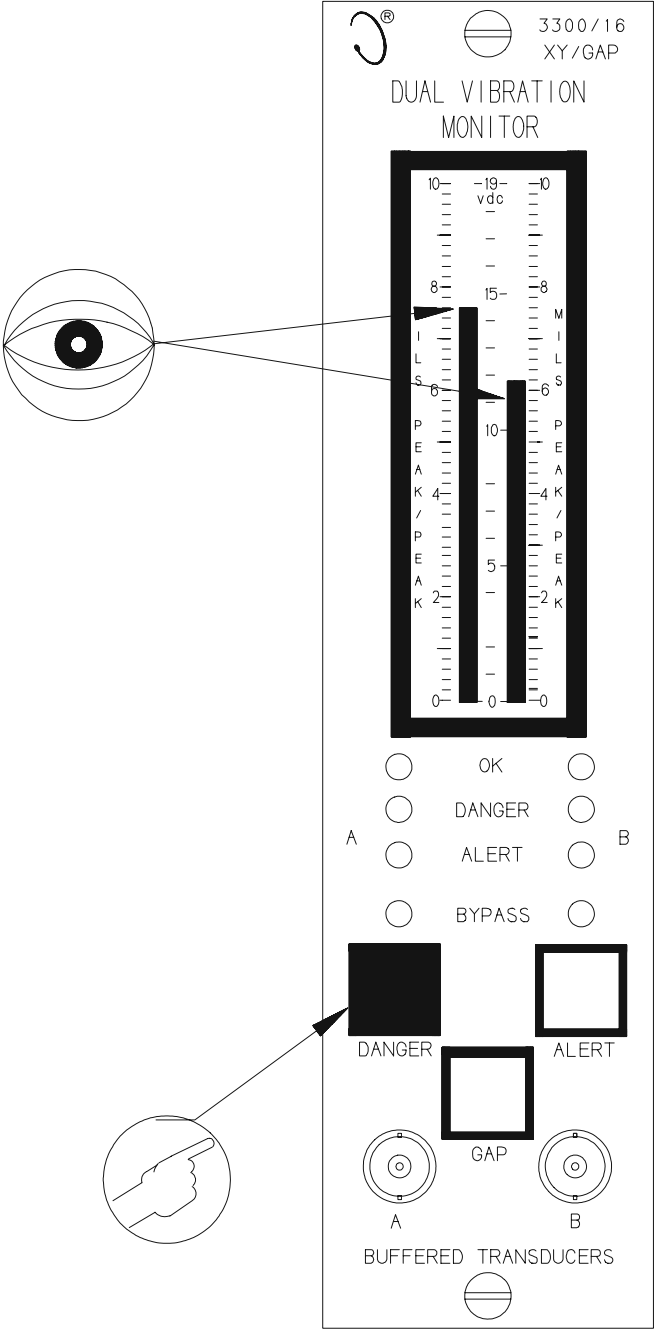

## 8. Monitor Removal

### **Caution**

Improper rack operation may occur.

Power down rack or inhibit rack alarms when installing or removing a monitor.

1. Loosen two screws.

2. Pull monitor from rack.

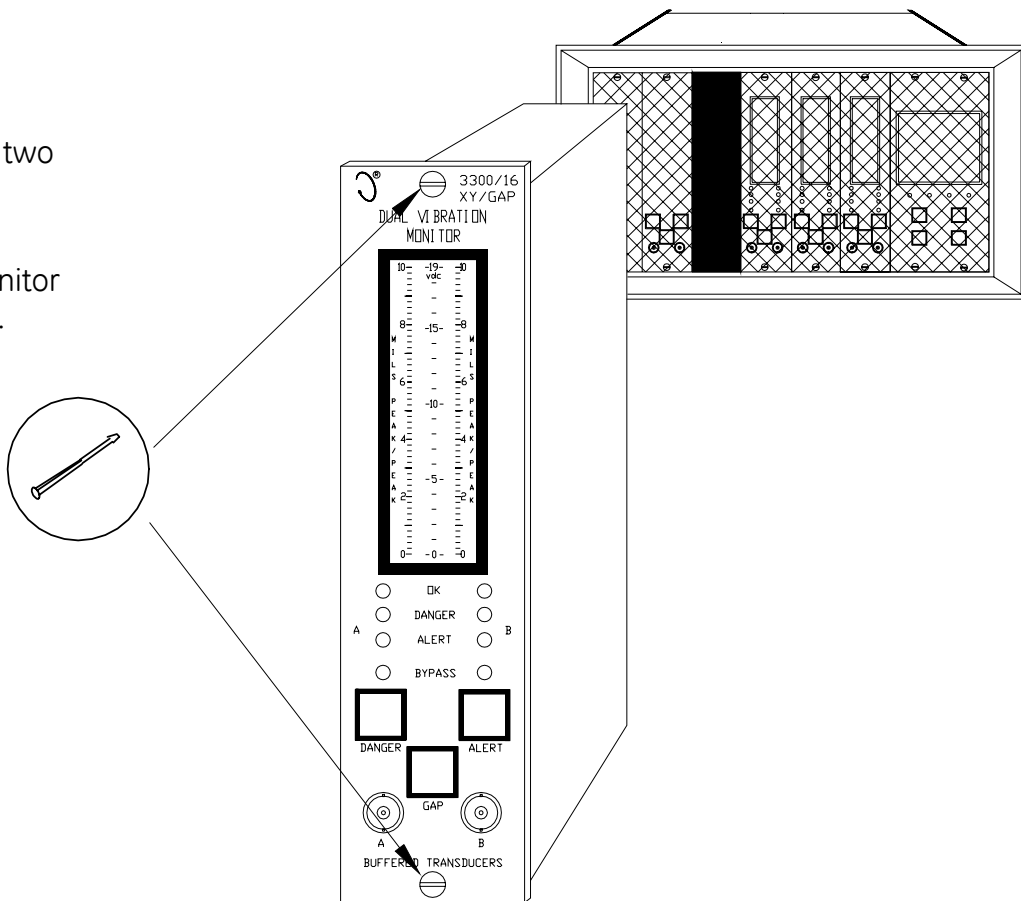

# 9. Monitor Disassembly

## 9.1 Side Cover Removal



### Caution

Components are sensitive to Electro-Static Discharge (ESD). Proper grounding should be implemented prior to removing the Side Cover Panel.

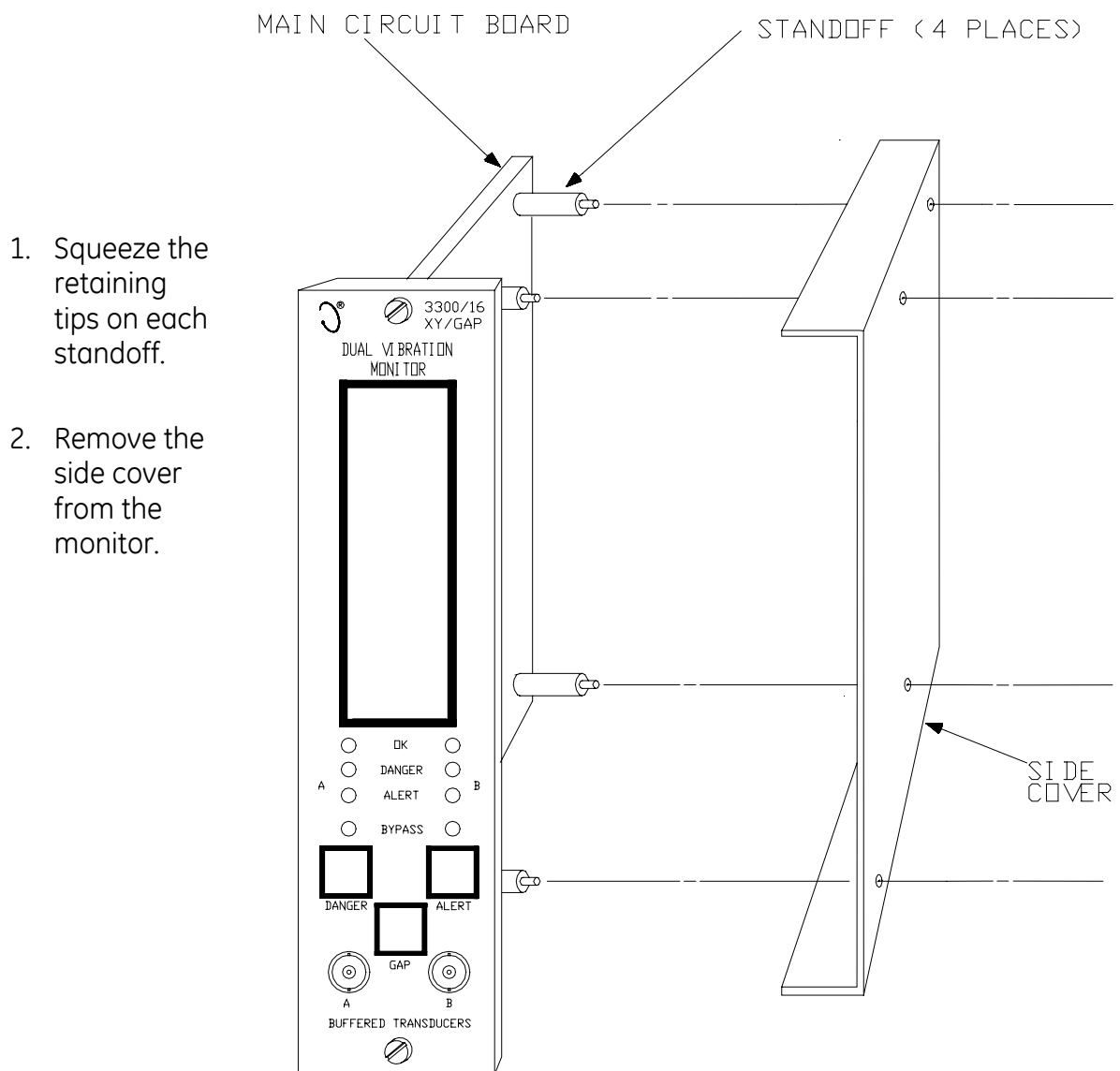

## 9.2 Front Panel Removal

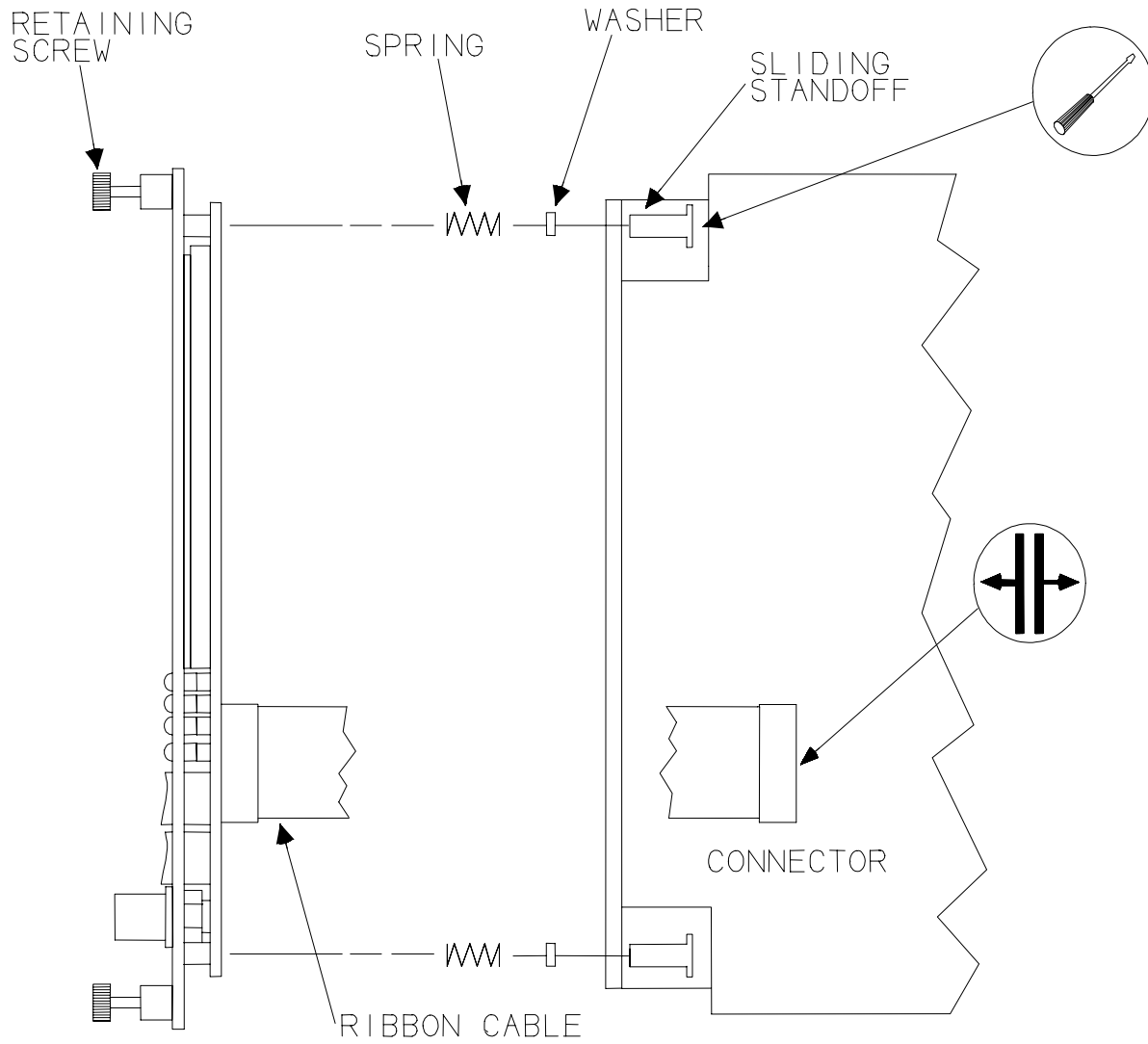



## WARNING

High voltage present. Contact could cause shock, burns, or death.

Do not touch exposed wires or terminals

### 9.3 Input Module

The Signal Input Relay Module is on the back of the rack.

For relay configuration, see 3300 System Installation Instructions.

For field wiring, see the Field Wiring Diagrams located behind the manual.

#### 9.3.1 Input Module Removal

1. Loosen two screws.
2. Pull the module from the rack.

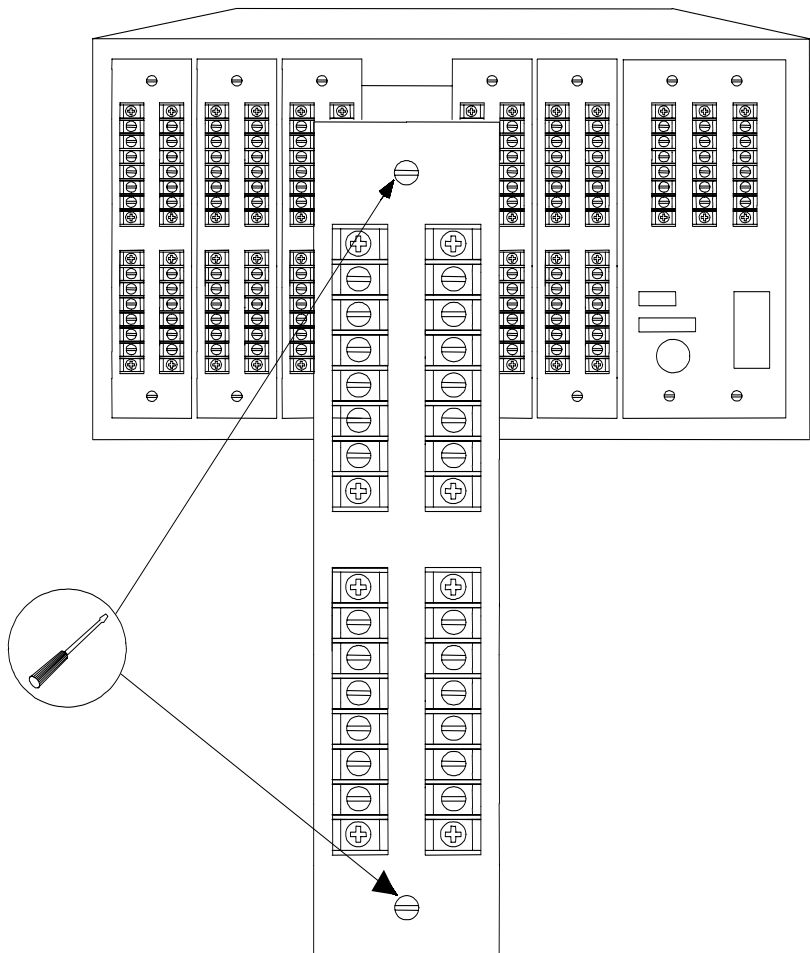

### 9.3.2 Dual Relay Module Options

Alert Relay	Jumper	
	In	Out
Normally Energized	W3	W4, W11
Normally De-energized*	W4, W11	W3
Danger Relay	Jumper	
	In	Out
Normally Energized	W2	W1, W12
Normally De-energized*	W1, W12	W2
OR Bus**	Jumper	
	In	Out
No Options*	-----	W5 - W8
Alert & Danger Bus 1	W6, W8	W5, W7
Alert & Danger Bus 2	W5, W7	W6, W8

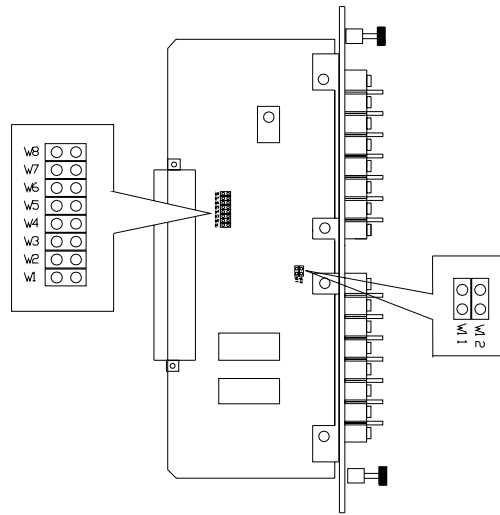

**Note:** For relay configuration of monitors with internal safety barriers, refer to the 3300 Internal Barrier Installation Manual or the 3300 System Installation Manual.

### 9.3.3 Quad Relay Module Options

Alert Relays	Jumper	
	In	Out
Normally Energized	W3A,W4C	W2,W3C W3B,W4D
Normally De-energized*	W2,W3C W3D,W4D	WA, W4C
Danger Relays	Jumper	
	In	Out
Normally Energized	W4B,W4F	W1,W3B W4A,W4E
Normally De-energized*	W1,W3B W4A,W4E	W4B,W4F

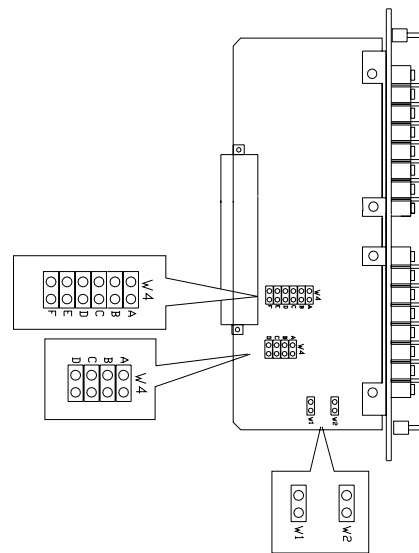

**NOTE:** For Quad Relays, AND voting logic must be done externally by wiring the contacts in series.

\* Shipped as options

\*\* OR Bus option is not available with Quad relays. See 80172 System Installation Guide.



# 10. Monitor Options

PART NUMBER	FULL SCALE RANGE	TRANSDUCER INPUT	ALARM RELAY	AGENCY APPROVAL
3300/16 - AXX -		BXX -	CXX -	DXX
01 = 0 - 3 mil pp 02 = 0 - 5 mil pp 03 = 0 - 10 mil pp 04 = 0 - 15 mil pp 05 = 0 - 20 mil pp 11 = 0 - 100 µm pp 12 = 0 - 150 µm pp 13 = 0 - 200 µm pp 14 = 0 - 400 µm pp 15 = 0 - 500 µm pp	01 = 3300 8mm or 7200 5mm & 8mm or 3300XL 8mm Proximitor® Sensor 200 mV/mil 02 = 3000 Proximitor® Sensor 200 mV/mil 03 = 7200 11mm Proximitor® Sensor 100mV/mil 04 = 3300 HTPS 16mm 7200 14 mm 3300 XL 11 mm Proximitor® Sensor 100 mV/mil 05 = 3300 RAM Proximitor® Sensor 200 mV/mil	00 = NONE 01 = EPOXY SEALED 02 = HERMETICALLY SEALED 03 = QUAD RELAY	00 = NOT REQUIRED 01 = CSA/NRTL 02 = BASEEFA	

BARRIERS USED

TRIP MULTIPLY

EXX - FXX

00 = NO	00 = NONE
01 =EXTERNAL *	01 = 2X TRIP MULTIPLY
02 = INTERNAL	02 = 3X TRIP MULTIPLY

\* External barriers should only be used with 3300 8mm or 7200 5mm & 8 mm or 3300XL 8mm Proximitor® Sensors and 3300 RAM Proximitor® Sensors. \* See Calibration Section **17.2** for more information.

NOTE: Verify that the transducer power supply level (-Vt) is appropriate for the transducer being used. Both the Power Supply and the System Monitor must be programmed to supply the correct voltage. The 3000 transducer requires a

supply voltage of -18 Vdc, while the 3300 and 7200 transducers require -24 Vdc. Power converter (part number 89634-01) can be used to convert -24 Vdc to -18 Vdc for use with the 3000 transducer.

## IMPORTANT!

Due to continuing changes in technology, the Main PWA (printed wiring assembly) has been upgraded to improve functionality and manufacturability. The Main PWA in the Dual Vibration Monitor can be one of three versions depending on when you purchased your monitor.

The general functionality of all three PWAs is the same, except Error Code #9 has been updated to test additional circuitry on PWA 140720-01.

Since the different versions require that you use different jumpers to set programmable options, you need to use different Appendices of this manual to program your monitor. The following table shows how to identify your PWA and lists which Appendix to use to program your monitor.

<b>PWA Version</b>	<b>PWA Number (printed on the top side of the board)</b>	<b>Section that shows jumper locations and the jumper settings for each PWA</b>
Original	86739-01	Appendix C
Second Generation	135305-01	Appendix B
Third Generation	140720-01	Appendix A

# 11. Meter Scale Replacement

To replace a meter scale:

1. Set the vibration full-scale range and gap full-scale range. (See Section 10, Monitor Options)
2. Cut the selected vibration meter scale and clear adhesive backed gap scale from the back of this manual. Be sure to cut along the marked outline so the meter scales will fit properly.
3. Remove the backing from the clear adhesive backed gap scale.
4. Position the gap scale such that the bottom tick mark lines up with the bottom tick mark of the vibration meter scale.
5. Remove the old meter scale from the monitor and replace it with the new one.

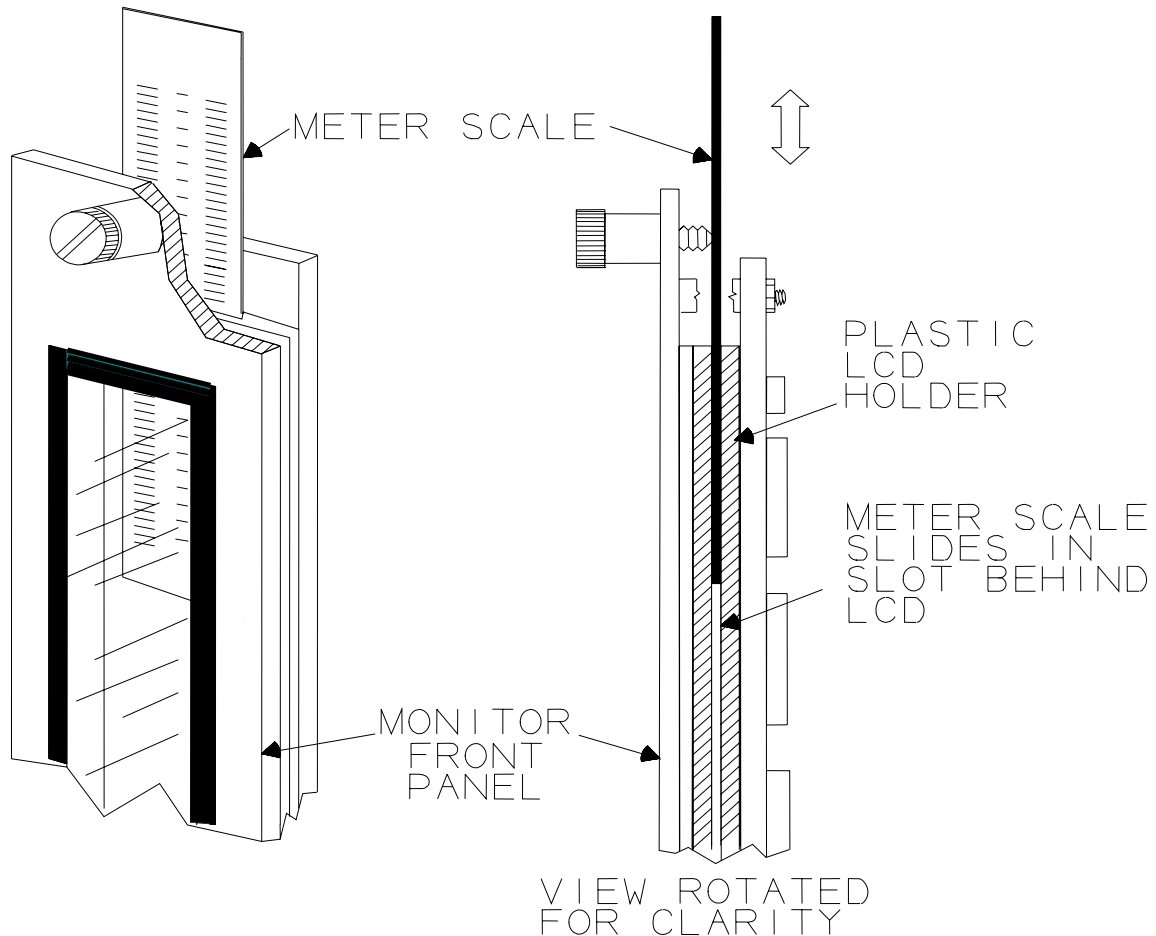

# 12. Alarm Setpoint Adjustment

## 12.1 Alert and Danger Setpoint Adjustment



### Caution

Changing Alarm Setpoints will change the trip levels of the machine.

1. Open front panel.
2. Set the adjust channel A switch (**AA**) to the left (ON). The left (Channel A) bargraph will start flashing the channel A vibration signal.

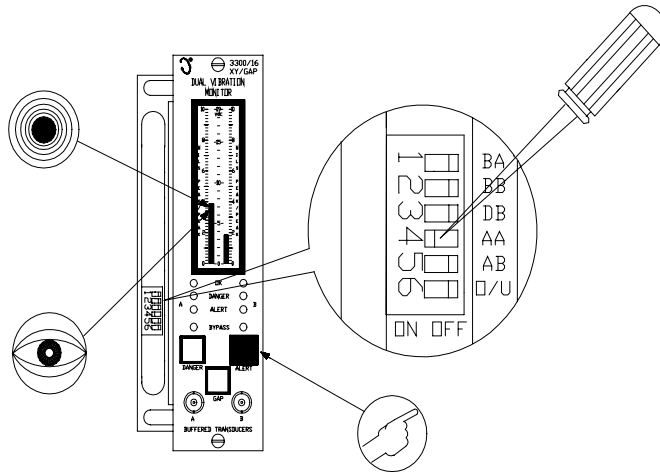

3. Press and hold the **ALERT** or **DANGER** switch on the front panel. Use the outer meter scale.
4. Press the (↑) or (↓) switches on the System Monitor to adjust the setpoint level up or down.

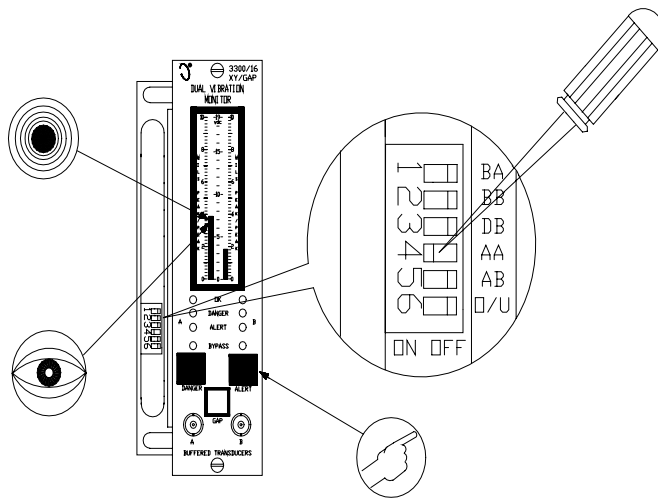

## 12.2 Gap Alert Setpoint Adjustment

1. To adjust Gap Alert setpoints, first select Under Gap setpoints by setting the Over/Under (**O/U**) switch to the right.
2. Press and hold the **GAP** and **ALERT** switches simultaneously on the front panel. The left bargraph will flash the Gap Alert setpoint window. Use the center meter scale.
3. Use the (↑) or (↓) switches on the System Monitor to adjust the Under Gap setpoint level up or down.
4. Repeat steps 2 and 3 for Over Gap Alert setpoints after setting the Over/Under (**O/U**) switch to the left.
5. Reset **AA** to the right (OFF).

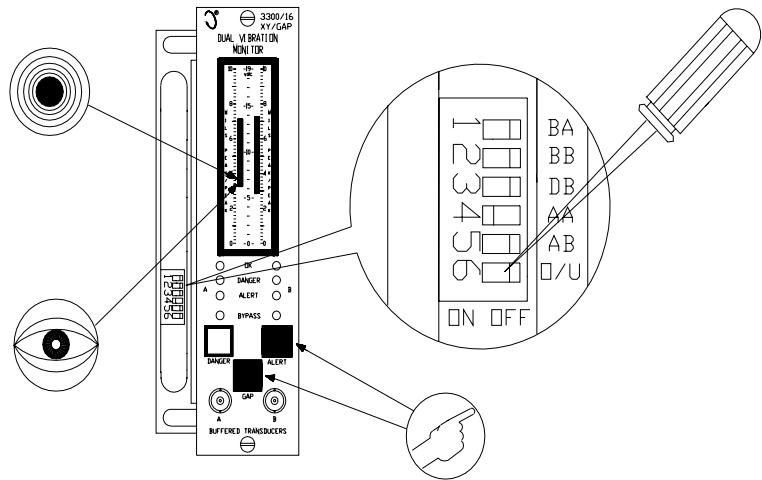

## 12.3 Channel B Adjust

1. Set the Adjust channel B switch (**AB**) to the left (ON) and repeat steps 12.1.3, 12.1.4 and section 12.2 above.
2. Reset **AB** to the right (OFF).
3. Close front panel.

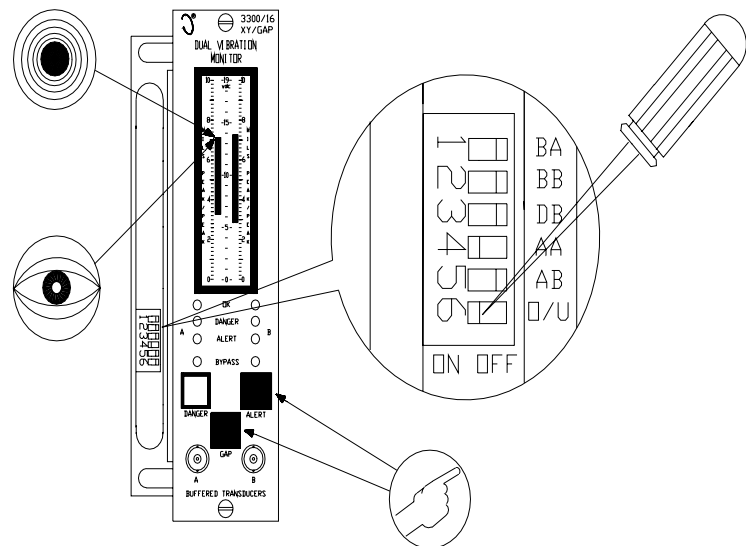

# 13. Channel Bypass

You can use Channel Bypass to take a NotOK or unconnected channel off line. This will restore the OK Relay to the OK state. The OK Relay will de-energize (go NotOK) if any channel in the rack is in a NotOK condition.

1. Set **BA** (Bypass Channel A) or **BB** (Bypass Channel B) switch to the left (ON) to bypass channel A or B.
2. The **BYPASS** LEDs come on, the **OK** LEDs go off, and the vibration signal is clamped to zero position (bottom scale).



## Caution

Machine protection provided by this monitor will be lost while Channel Bypass is on.

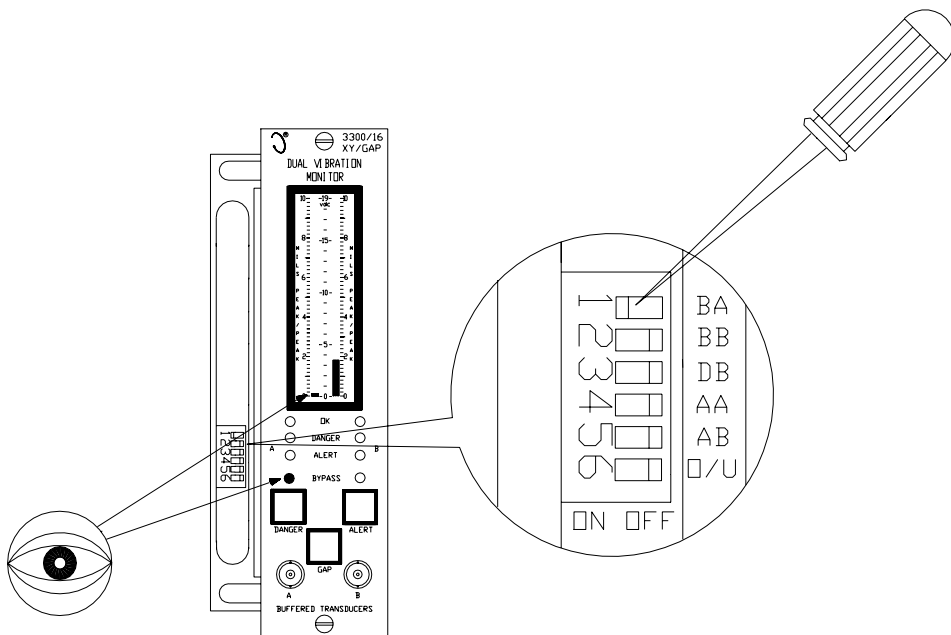

### NOTE

Channel alarms are cleared when Channel Bypass is switched on.

## 14. Danger Bypass

You can use Danger Bypass to bypass the DANGER Relay. The **DANGER** alarm LEDs on the front panel can come on but the DANGER Relay drive will not be activated if a Danger setpoint is exceeded.

1. Set **DB** to the left (ON) to Bypass the Danger Relay.
  - For the Danger Bypass (**DB**) switch to function, the Danger Bypass Enable jumper must be installed. See Monitor Options, **Section 10**, for more information.
2. Both **BYPASS** LEDs come on. The **OK** LEDs will remain on as long as the transducer remains within its OK range.

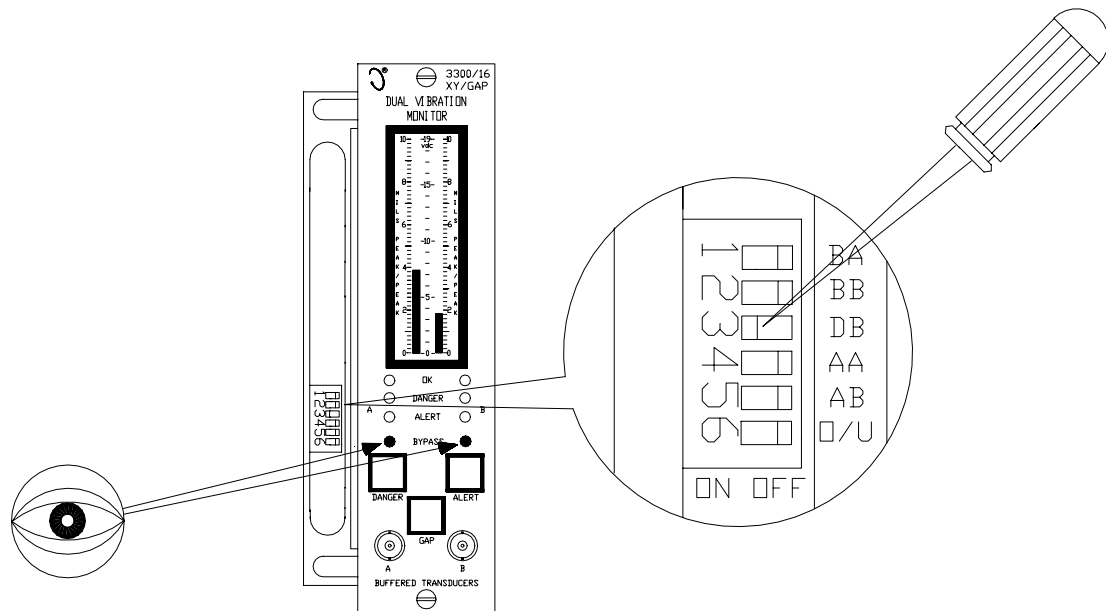



### NOTE

Channel alarms are cleared when Channel Bypass is switched on.

# 15. Test Alarms

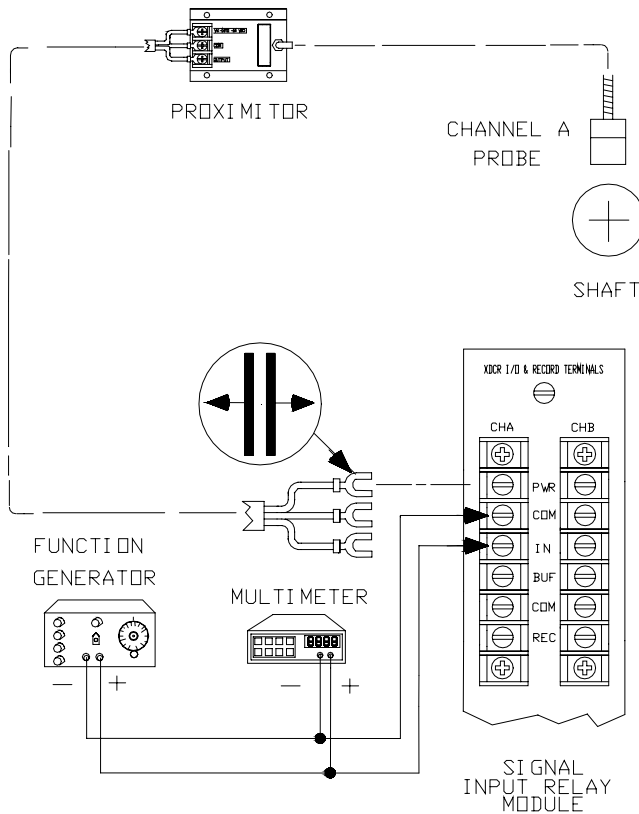
## 15.1 Test Equipment Setup





### WARNING

High voltage present.  
Contact could cause shock,  
burns or death.

**Do not touch exposed wires  
or terminals.**



### Caution

Tests will exceed alarm setpoint  
levels and cause alarms to  
activate. Relay contacts may  
change state. See Danger  
Bypass section 14.

1. Disconnect the **COM** and **IN** wiring from the channel A terminals on the Signal Input Relay Module.
  2. Connect the multimeter and the function generator (at 100 Hz and -9 Vdc bias) as shown above.
- In the event the function generator cannot supply the necessary DC offset, a floating DC Power Supply will need to be connected in series with the function generator. Connect the positive terminals of the function generator and power supply, connect the negative terminal of the power supply to **IN** signal and the negative terminal of the function generator to the **COM** signal.
  - NOTE: the DC offset must be within the gap alarm setpoint window to avoid tripping the Gap alarm. If the recommended -9 Vdc offset is not within this window, adjust the function generator accordingly.



## 15.2 Test Channel Alarms

1. To test vibration alarms for channel A, adjust the signal amplitude such that the vibration signal is below the Alert and Danger alarm setpoint levels on the monitor.
2. Wait for the 30-second Timed OK/Channel Defeat delay time to elapse. At the end of the delay the **BYPASS** LEDs will go off and the **OK** LEDs will come on, flashing at 1 Hz.
3. Press the **RESET** switch and verify that the **OK** LEDs are on, and the **ALERT** and **DANGER** LEDs are off.

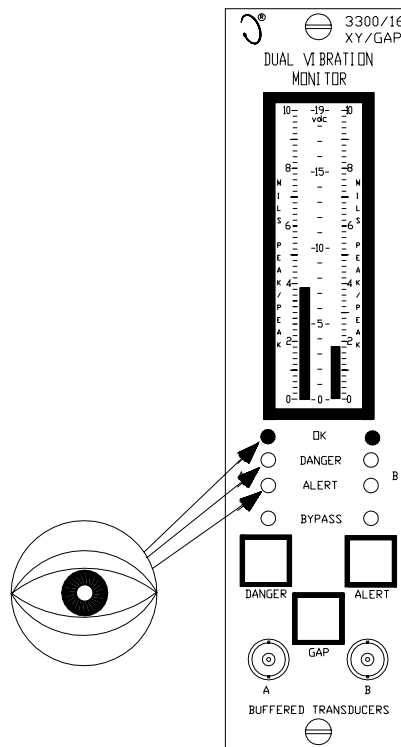

4. Adjust the function generator such that the vibration signal on the monitor just exceeds the Alert setpoint level and verify that the **ALERT** LED comes on after the optioned vibration alarm delay period has elapsed (flashing if the First Out option is selected).
5. Verify that the Alert relay changed state.
6. Press the **RESET** switch on the System Monitor and verify that the **ALERT** LED remains on and steady (and flashing stops after reset occurs if First Out option is selected).

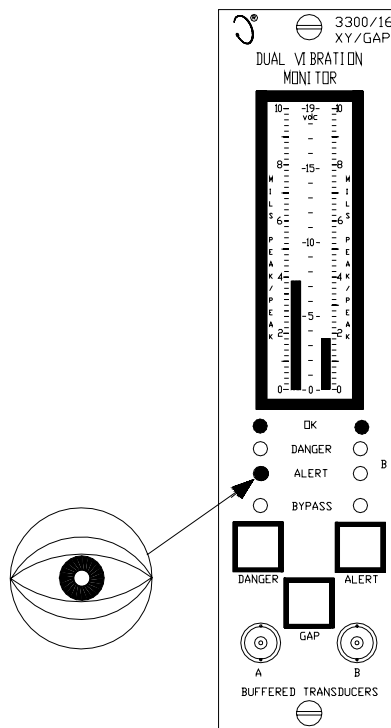

7. Adjust the signal amplitude such that the vibration signal on the monitor just exceeds the Danger setpoint level and verify that the DANGER LED comes on after the optional vibration alarm delay period has elapsed (flashing if First Out option is selected).
8. Verify that the Danger relay changed state. If Danger 'AND' voting logic option is selected, the relay will not change state until the other channel exceeds the Danger setpoint. 'AND' voting is not active if the second channel is bypassed. The relay will not change state if Danger Bypass is on.
9. Press the **RESET** switch on the System Monitor. Verify that the **ALERT** and **DANGER** LEDs remain on and steady.

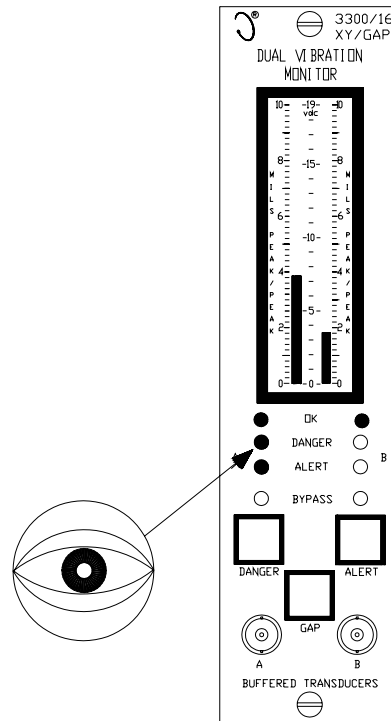

10. Reduce the function generator amplitude such that the vibration signal reads below the alarm setpoints and observe that the **ALERT** and **DANGER** LEDs go off (If the nonlatching alarm jumper is installed).
11. Press the **RESET** switch on the System Monitor to reset latching alarms.
12. If the monitor Trip Multiply option 'FF' is -01 or -02 (see Monitor Options, Section 10), steps 15.2.1 through 15.2.11 must be repeated in the Trip Multiply mode (2X or 3X) with Trip Multiply activated. (The **TRIP MULTIPLY** LED on the System Monitor will come on when Trip Multiply is activated). In the Trip Multiply mode, the setpoints are multiplied by either 2X or 3X.

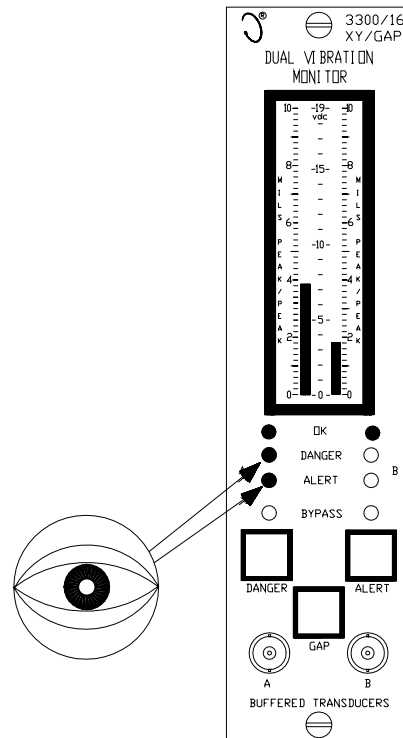

### 15.3 Test Gap Alarms

- If the Gap Full Scale Range option is in engineering units instead of volts, this section still applies with the exception that the gap value will be referenced to zero position at the center of the meter scale.
1. To test Gap alarms for Channel A, Press the **GAP** switch and adjust the function generator DC bias so that the Gap voltage is within the gap alarm setpoint window (See section 7 for viewing the gap Alert setpoint window).
  2. Press the **RESET** switch and verify that the **OK** LEDs are on, and the **ALERT** and **DANGER** LEDs are off.

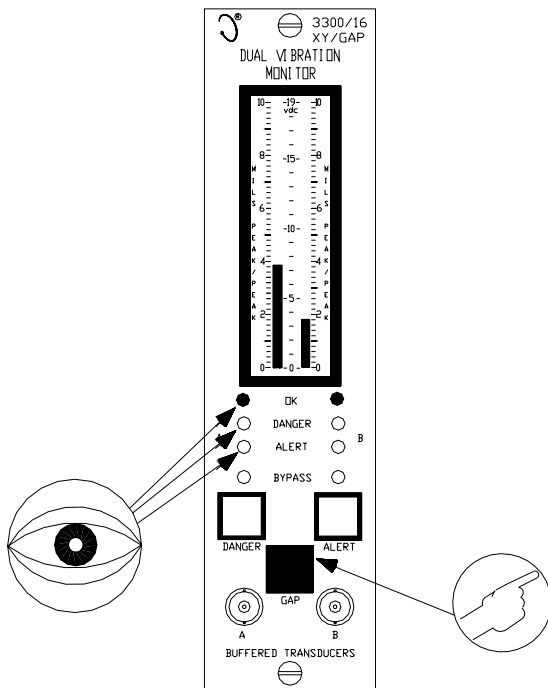

3. Adjust the gap voltage on the monitor to just exceed the Over Gap Alert setpoint level and verify that the **ALERT** LED comes on after the 6 second delay period has elapsed (flashing if the First Out option is selected).
- Verify that the Alert relay changed state.
4. Press the **RESET** switch on the system monitor and verify that the **ALERT** LED remains on and steady.

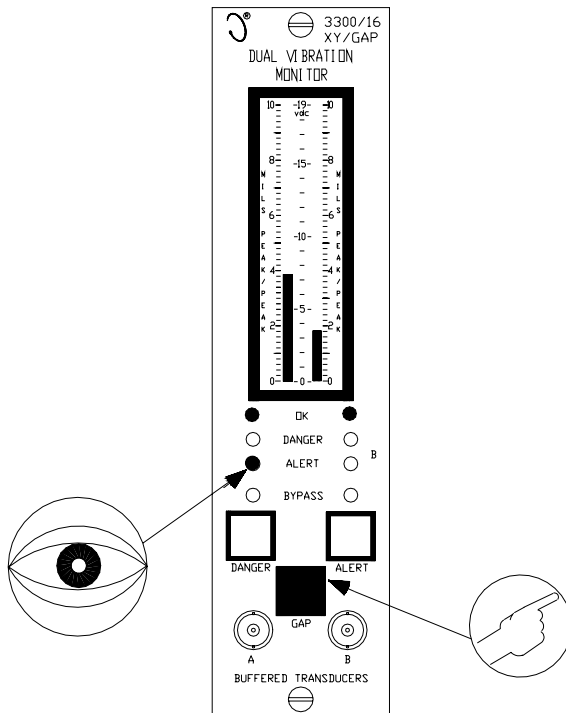

5. Reduce the gap voltage to read below the Over Gap setpoint (and above the Under Gap Setpoint) and observe that the **ALERT** LED goes off (if the nonlatching alarm jumper is installed). Press the **RESET** switch on the System Monitor to reset latching alarms.
6. Repeat section **15.3** for under Gap alarms, adjusting the gap signal to be below the Under Gap Alert setpoint.

## 15.4 Channel B and Reinstallation

1. Reconnect the wiring to the Signal Input Relay Module that was discussed in section **15.1**.
2. Repeat sections **15.1** through **15.3** connecting the multimeter and function generator to the channel B terminals.
3. If the Channel Bypass or Danger Bypass functions were activated for this procedure, deactivate them by setting the appropriate switches (**BA**, **BB**, or **DB**) to the right (OFF).

# 16. Test OK Limits

## 16.1 Test Equipment Setup

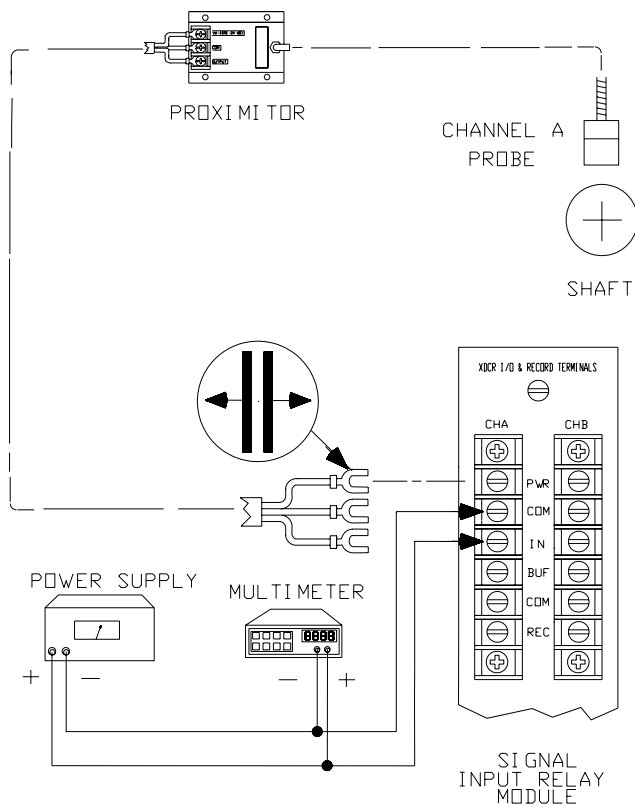



### WARNING

High voltage present.  
Contact could cause shock, burns or death.

Do not touch exposed wires or terminals.



### Caution

Tests will exceed Gap Alert setpoint levels and cause alarms to activate (if enabled). Relay contacts may change state. See Main

1. Disconnect the **COM** and **IN** wiring from the channel A terminals on the Signal Input Relay Module.
  2. Connect the multimeter and the power supply to channel A terminals as shown above.
  3. Adjust the power supply voltage to -9 Vdc with respect to common.
  4. Verify that the channel A **OK** LED is on.
- In the event the function generator cannot supply the necessary DC offset, a floating DC Power Supply will need to be connected in series with the function generator. Connect the positive terminals of the function generator and power supply, connect the negative terminal of the power supply to **IN** signal and the negative terminal of the function generator to the **COM** signal.

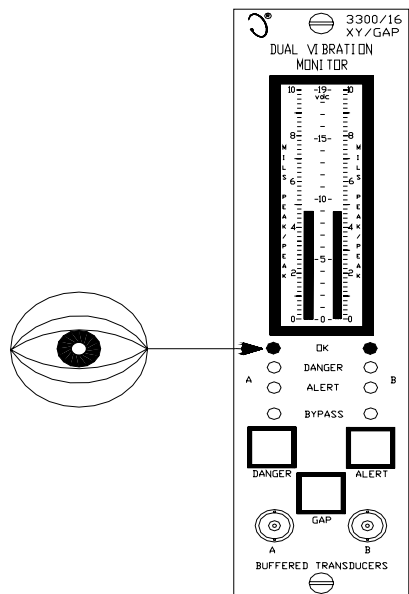

## 16.2 Test Upper OK Limit

1. Increase the power supply voltage (more negative) until the **OK** LED goes off (upper limit).
  - Verify that the upper OK limit is within the upper OK voltage range (reference Table 4 on the next page).
  - Verify that the OK Relay changes state (de-energized). Note: All other channels in the rack must be OK or bypassed in order for the relay to change state.
2. Decrease the power supply voltage (less negative) to -9 Vdc and verify that the **OK** LED comes back on after the 30-second Timed OK/Channel Defeat delay, and the OK Relay energizes. Press the **RESET** switch on the System Monitor to reset the flashing **OK** LED.

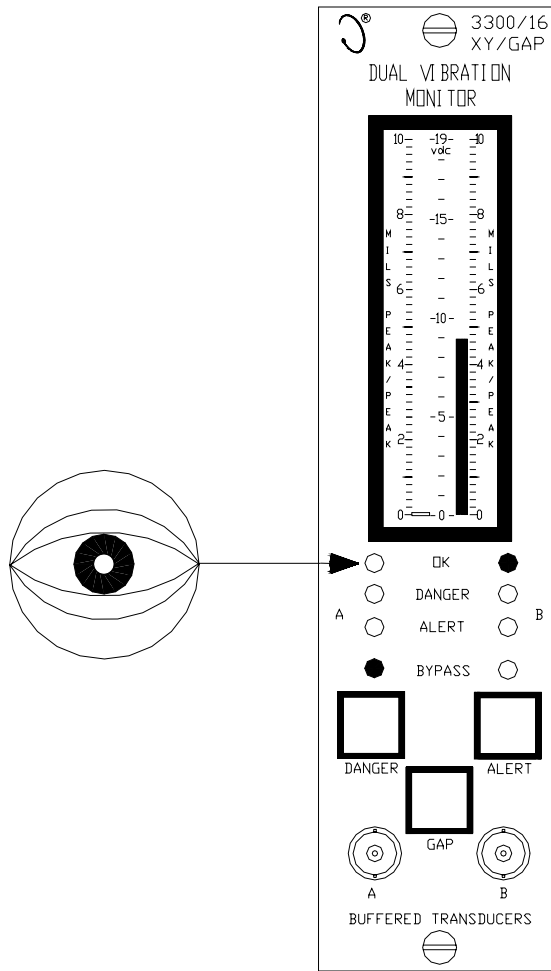

## 16.3 Test Lower OK Limit

1. Gradually decrease the power supply voltage for channel A (less negative) until the channel A **OK** LED goes off (lower limit). Verify that the lower OK limit is within the lower OK voltage range (reference Table 4).
2. Verify that the OK Relay de-energizes.
3. Increase the power supply voltage for channel A to -9 Vdc. Press the **RESET** switch on the System Monitor to reset the flashing **OK** LED.

## 16.4 Channel B and Reinstallation

1. When finished, disconnect the power supply and multimeter and reconnect the **COM** and **IN** wiring to the channel terminals on the Signal Input Relay Module. Verify that the **OK** LED comes on and the OK Relay energizes. Press the **RESET** switch on the System Monitor to reset the flashing **OK** LED.
2. Repeat sections **16.1** through **16.3** for channel B with the multimeter and power supply connected to channel B terminals.
3. If Channel Bypass or Danger Bypass functions were activated for this procedure deactivate them by setting the appropriate switches (**BA**, **BB**, or **DB**) to the right (OFF).

TABLE 4. OK Voltage Limits		
Transducer Type Limits	Lower OK Voltage Limits	Upper OK Voltage
<b>Option -01 &amp; -04</b> 7200 5 & 8 & 14mm or 3300 8mm, 3300XL 8mm, 3300 16mm HTPS, 3300 XL 11mm	-2.7 Vdc to -3.3 Vdc	-15.8 Vdc to -16.8 Vdc
<b>Option -03</b> 7200 11mm	-3.28 Vdc to -3.68 Vdc	-18.6 Vdc to -19.6 Vdc
<b>Option -02 &amp; -05</b> 3000 & 3300 RAM	-1.7 Vdc to -2.1 Vdc	-10.5 Vdc to -11.6 Vdc

# 17. Calibrate Channels

## 17.1 Calibration Equipment Setup

 **WARNING**

High voltage present.  
Contact could cause shock, burns or death.

Do not touch exposed wires or terminals.

 **Caution**

Tests will exceed alarm setpoint levels and cause alarms to activate. Relay contacts may change state. See Danger Bypass Section 14.

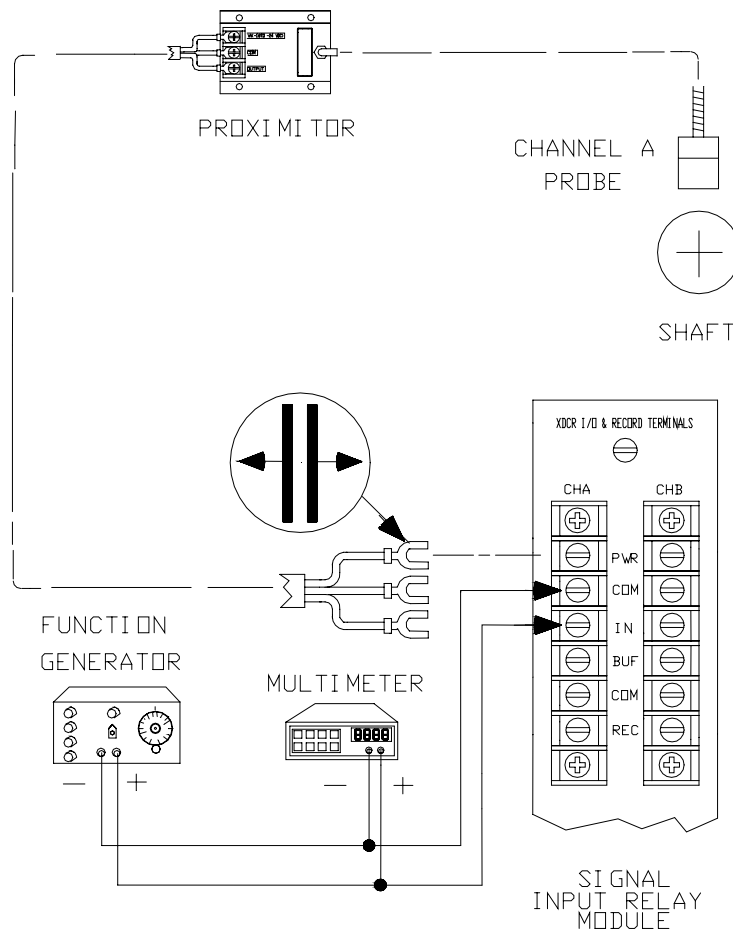



1. Disconnect COM and IN wiring from the channel A terminals on the Signal Input Relay Module.
  2. Connect function generator and multimeter to **COM** and **IN** with polarity as shown in the Calibration Setup diagram on the previous page.
- In the event the function generator cannot supply the necessary DC offset, a floating DC Power Supply will need to be connected in series with the function generator. Connect the positive terminals of the function generator and power supply, connect the negative terminal of the power supply to **IN** signal and the negative terminal of the function generator to the **COM** signal.

## 17.2 Calibration Procedure

1. Open front panel.
2. Adjust function generator to output a 100 Hz sine wave with -9 Vdc bias. Adjust the amplitude for meter full scale (1 V pp = 0.354 Vrms).

Transducer Type	Transducer Scale Factor
7200 5 & 8mm, 3000, 3300 8mm, RAM, and 3300XL 8mm (200 mV/mil) <b>NOTE:</b> External barriers only available for 3300 8mm transducers.	1 mil pp = 200 mV pp * 10 micrometres pp = 78.7 mV pp <b>*NOTE:</b> If external barriers are used, the scale factor through the barrier circuit is 200 mV/mil with a scale factor of 192 mV/mil going directly into the monitor.
7200 11 & 14mm, 3300 16mm HTPS & 3300 XL 11mm (100 mV/mil)	1 mil pp = 100 mV pp 10 micrometres pp = 39.4 mV pp

- **Example:**  
For a 3300XL 8mm transducer and a display of 5 mil pp full scale, the full-scale input voltage is:  
5 mils X 200 mV pp/1 mil = 1 V pp or:  
5 mils X 200 mV pp/1 mil X 0.354 Vrms/1 V pp = 0.354 Vrms

3. Measure the proportional signal output voltage at channel A test point (TA) using the multimeter as shown in the figure to the right and verify that it matches the table below.

Proportional Signal Output	
No Trip Multiply	+5.00 Vdc
2X Trip Multiply	+2.50 Vdc
3X Trip Multiply	+1.67 Vdc

3. If the voltage does not match the table above, adjust the gain potentiometer (**GA**) until the voltage at the channel A test point is correct for the Trip Multiply option installed.
  4. When finished, disconnect the function generator and multimeter and reconnect the **COM** and **IN** wiring to the channel terminals on the Signal Input Relay Module that was disconnected in step 1. Verify that the **OK** LED comes on and the OK Relay energizes. Press the **RESET** switch on the System Monitor to reset the flashing **OK** LED.
  5. Repeat sections 17.1 and 17.2 for channel B substituting **TB** for **TA** and **GB** for **GA**.
- If the Channel Bypass or Danger Bypass functions were activated for this procedure, deactivate them by setting the appropriate switches (**BA**, **BB**, or **DB**) to the right (OFF).

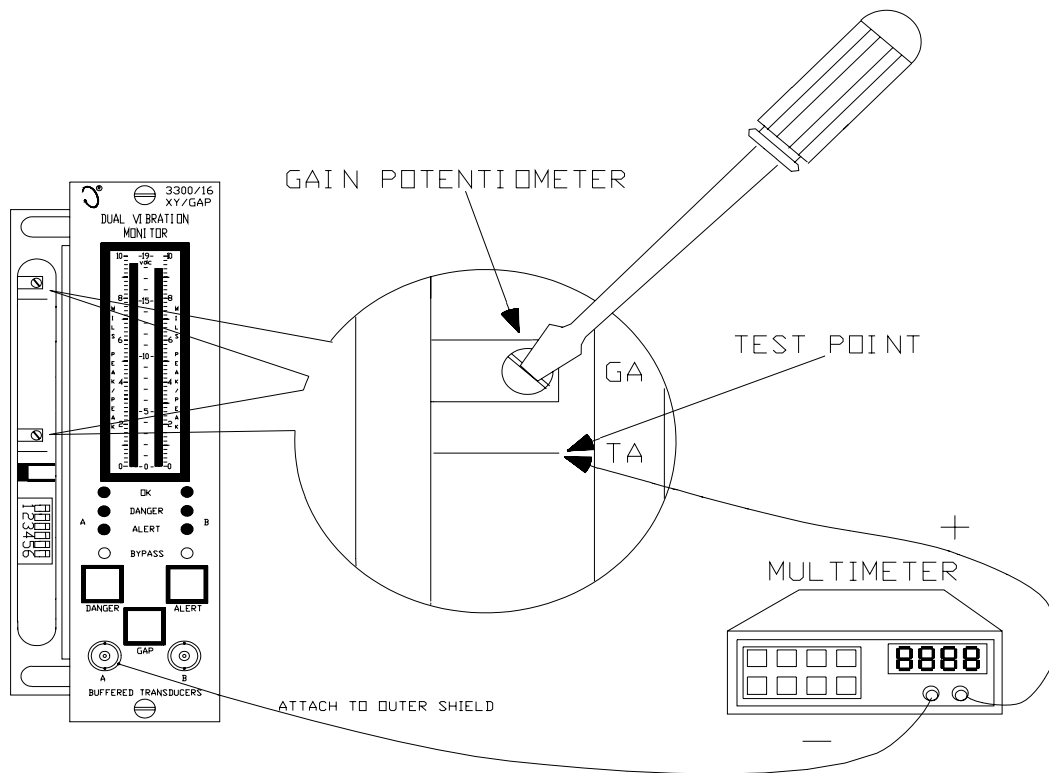

# 18. Zero Position Adjustment

**Note:** Before performing this procedure, verify that the probe gap voltage is at the value you want to set as your zero value.

1. Open the front panel.
2. Set the adjust channel A switch (**AA**) to the left. The left bargraph will start flashing the channel A vibration signal.
3. Press and hold the **GAP** switch on the front panel.

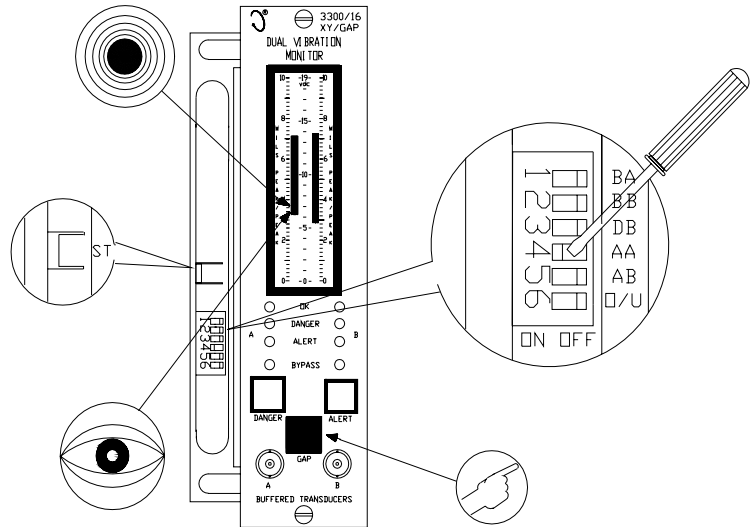

4. Short across the two self-test (**ST**) pins while the gap switch is being pressed. The current gap value is now stored as the new zero position.
5. Reset **AA** to the right (OFF).
6. Close front panel.
7. Repeat steps 1 to 6 for channel B using the adjust channel B switch (**AB**) and the right bargraph.

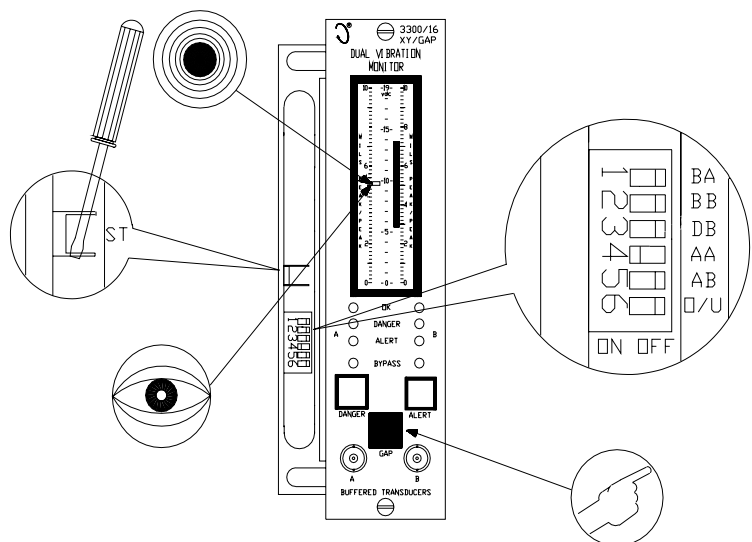

**NOTE:** The gap zero position voltage must be within the limits shown in the table below for the applicable transducer and gap full scale range or your gap full scale range may go outside the transducer OK limits.

GAP FULL-SCALE RANGES	3300 OR 7200 5 & 8mm OR 3300XL 8mm TRANSDUCER		7200 11MM TRANSDUCER	7200 14MM OR 3300 16mm HTPS OR 3300 XL 11mm TRANSDUCER	3000 TRANSDUCER
	w/external external barriers	w/o barriers			
15-0-15 mils	-6.18 to -12.92 V	-6.3 to -12.8 V	NA	NA	-5.1 TO -7.5 V
25-0-25 mils	-8.10 to -11.00 V	-8.3 to -10.8V	-6.18 to -16.1 V	-5.8 to -13.3 V	NA
50-0-50 mils	NA	NA	-8.68 to -13.6 V	-8.3 to -10.8 V	NA
300-0-300µm	-5.57 to -13.53 V	-5.66 to -13.44 V	NA	NA	-4.46 TO -8.14 V
600-0-600µm	-7.84 to -11.26V	-8.02 to -11.08 V	-6.04 to -16.24 V	-5.66 to -13.44 V	NA
1000-0-1000µm	NA	NA	-7.62 to -14.66 V	-7.24 to -11.86	NA

GAP FULL-SCALE RANGES	3300 RAM TRANSDUCER	
	w/ external barriers	w/o external barriers
15-0-15 mils	-4.98 to -7.62 V	-5.1 to -7.5 V
25-0-25 mils	NA	NA
50-0-50 mils	NA	NA
300-0-300µm	-4.37 to -8.23 V	-4.46 to -8.14 V
600-0-600µm	NA	NA
1000-0-1000µm	NA	NA

# 19. Self Test

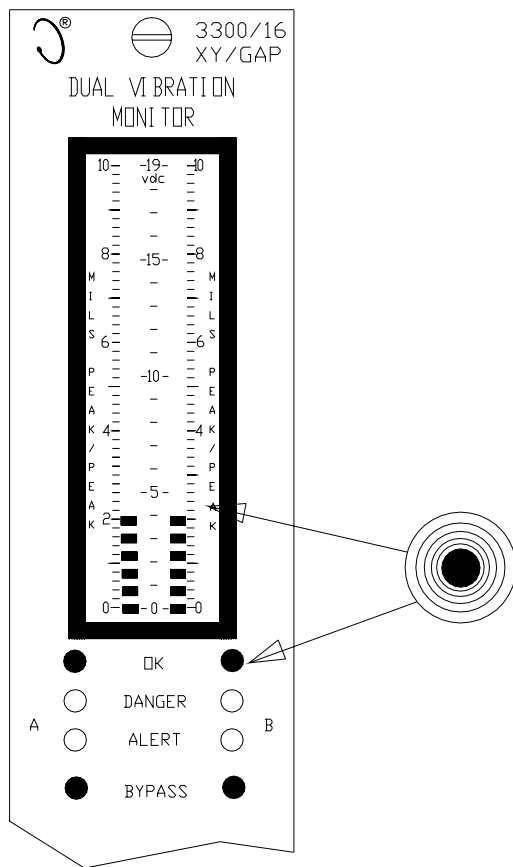

The monitor has three levels of self-test:

SELF TEST	PERFORMED
Power - up	When the monitor is turned on.
Cyclic	Continuous during monitoring operations.
User-invoked	When you initiate the self-test by temporarily shorting the self-test pins.

When the monitor detects an error, it displays an error condition in one of two ways depending on whether the error is active or stored.

- An active error is an error that currently exists.
- A stored error indicates that a storable error has occurred since the last time errors were cleared but this error is no longer active.

If the monitor detects an active error, the following events occur:

- Monitoring stops until the problem is resolved
- The error code is stored in memory and flashes on the LCD bargraph
- The **BYPASS** LEDs come on
- The **OK** LEDs flash at 5 Hz

If the monitor no longer detects an active error and a stored error exists, the following events occur:

- Monitoring resumes
- If the **OK** LED would otherwise be on, the **OK** LEDs flash at 5 Hz to indicate that an error code has been stored.

Recall stored error codes by using the User-invoked self-test. Use the following steps to run the User-invoked self-test, read error codes, and clear stored error codes:



## Caution

Machine protection will be lost during calibration and for the duration of the self-test.

**NOTE:** User-invoked self-test cannot be initiated if any error is active. Refer to the Error Codes section for more information on the error codes.

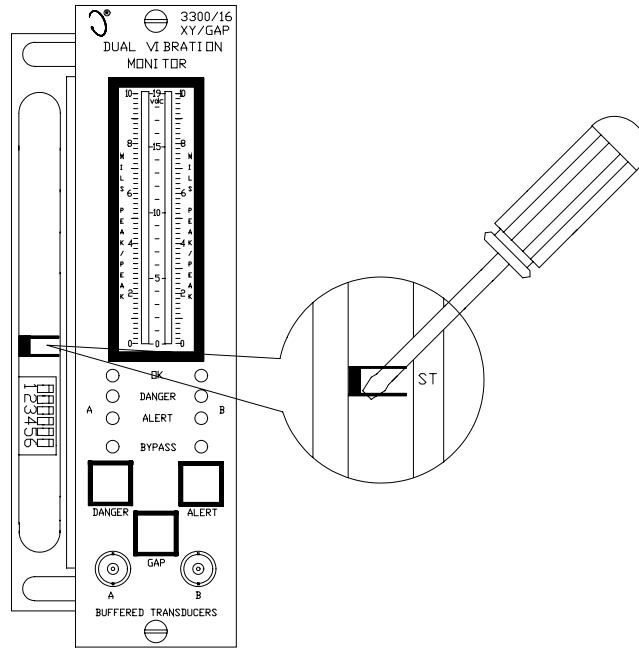

1. Initiate the User-invoked self-test by shorting the two self-test pins (**ST**) with a screwdriver. All the LEDs and LCD elements will come on for 5 seconds.
2. If an active or stored error is present at the end of the self test, the **BYPASS** LEDs remain on, the **OK** LEDs flash at 5 Hz, and the first error code flashes at 2 Hz.
  - The error code is given by the number of flashing segments in one column of the bargraph.

For example, this monitor is indicating error code number 6.

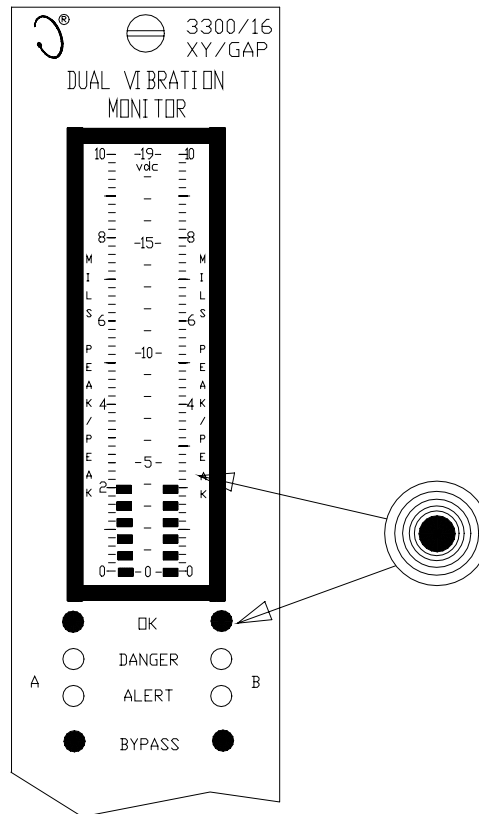

3. Read any other stored error codes by pressing and holding the **ALERT** switch for approximately one second.

For example, the display to the far right contains a second stored error code - number 10.

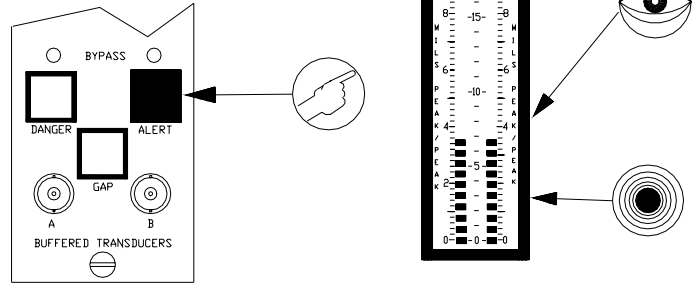

- When you reach the end of the error code list, the LCD bargraph comes on at full scale range and the **OK** LEDs turn off.
- You may read through the list again by continuing to press the **ALERT** switch.

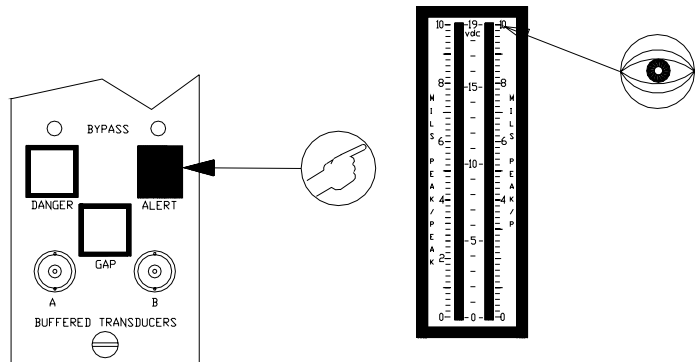

3. When the LCD bargraph is at full scale, clear error codes from memory by pressing and holding the **DANGER** switch for approximately one second.
4. If Timed OK/Channel Defeat is selected, after you clear the error codes (and after the 30-second Timed OK/Channel Defeat period elapse), the **OK** LEDs will flash at 1 Hz to indicate that the monitor has been NotOK.

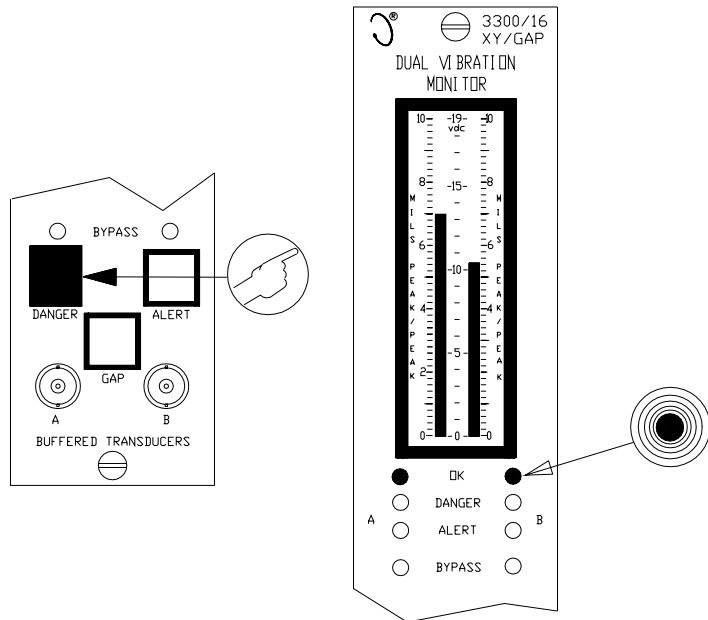

When you press the RESET switch on the System Monitor, the OK LEDs will stop flashing.

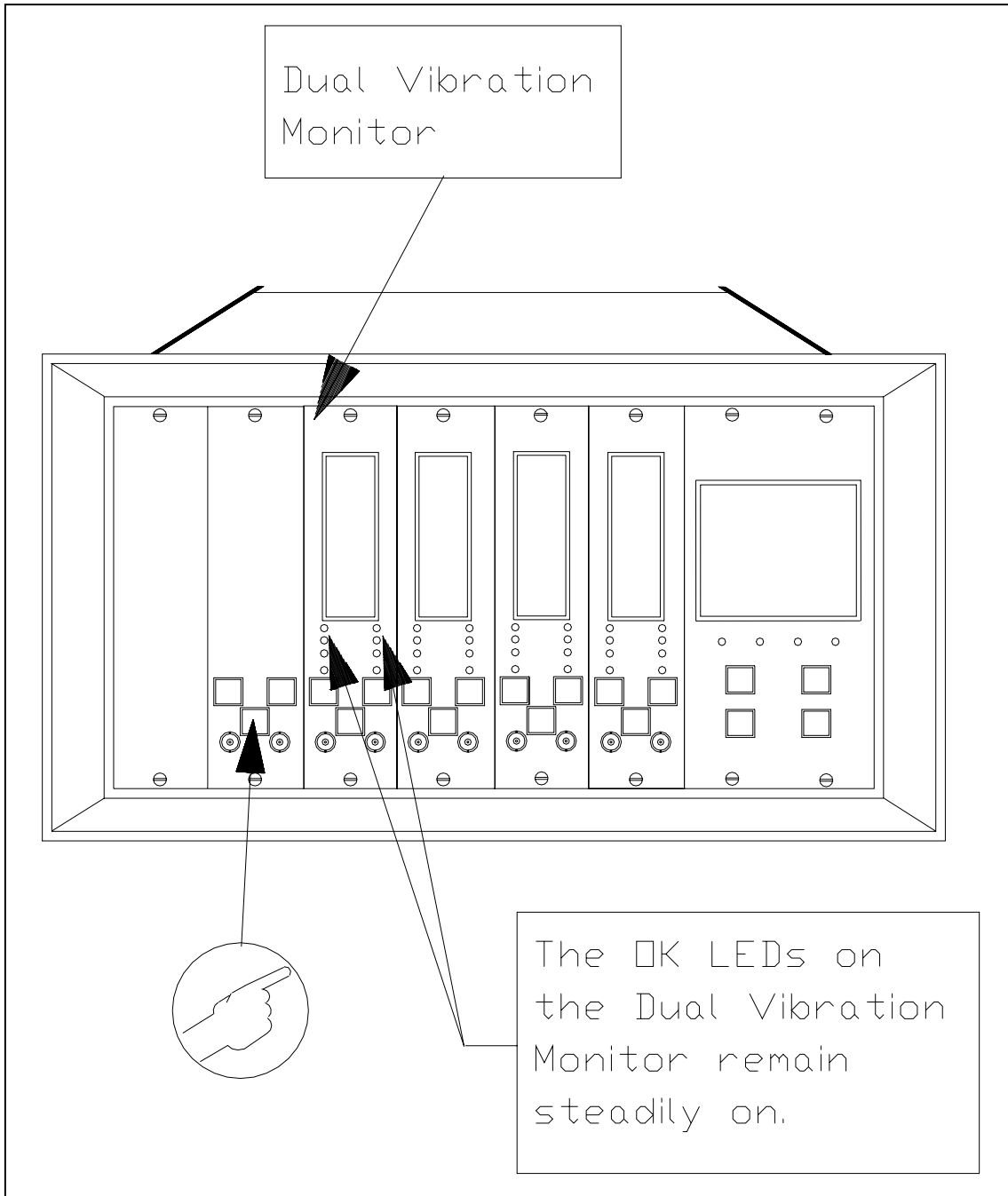



## 20. Error Codes

ERROR CODE	DESCRIPTION	EXPLANATION/RECOVERY
2	ROM checksum failed.	Tested at Power-up and User-invoked self test. This error is displayed on the front panel, but is not stored in memory. Install your spare monitor or contact your local Bently Nevada office for service.
3	Non-recoverable EEPROM failure.	Tested only at Cyclic self test. Install your spare monitor or contact your local Bently Nevada office for service.
4	EEPROM failure.	May be corrected by adjusting alarm setpoints in the monitor (see section <b>12</b> ). If setpoint adjustment fails to correct this error, install your spare monitor or contact your local Bently Nevada office for service.
5	+7.5/-VT node out of tolerance.	<p>Tested cyclically. If it is a stored error, recall and clear the error codes as described in the Self Test section.</p> <p>If it is an active error, replace the monitor with a spare or contact your local Bently Nevada office for service.</p>
6	+VRH node out of tolerance.	
7	+5V node out of tolerance.	
8	MVREF node out of tolerance.	
9	+7.5V node out of tolerance.	
10	+VRL node out of tolerance.	
11	MVREF/-6.5V node out of tolerance.	
12	+5V/-7.5 node out of tolerance.	
13	Clock OK voltage out of tolerance.	
14	RAM failure.	
17	COP watchdog not configured.	
22	<b>Incorrect jumper configuration.</b>	Tested cyclically. This error is not stored in memory. Correct the jumper configuration of the transducer option or the gap full scale option so that the two are compatible (See section <b>21, 22, or 23</b> ).
NOTE: If the monitor experiences recurring stored errors contact your local Bently Nevada office for service.		

# 21. Appendix A – Monitor Options for PWA 140720-01

## 21.1 Jumper Locations for PWA 140720-01

**IMPORTANT!**

W19, 22, 23, 26, and 27 are for factory use only and should not be changed. These jumpers are labeled "Factory Use Only" on the PWA.

For normal operation W19, W22, W23, W26, and W27 should be removed.

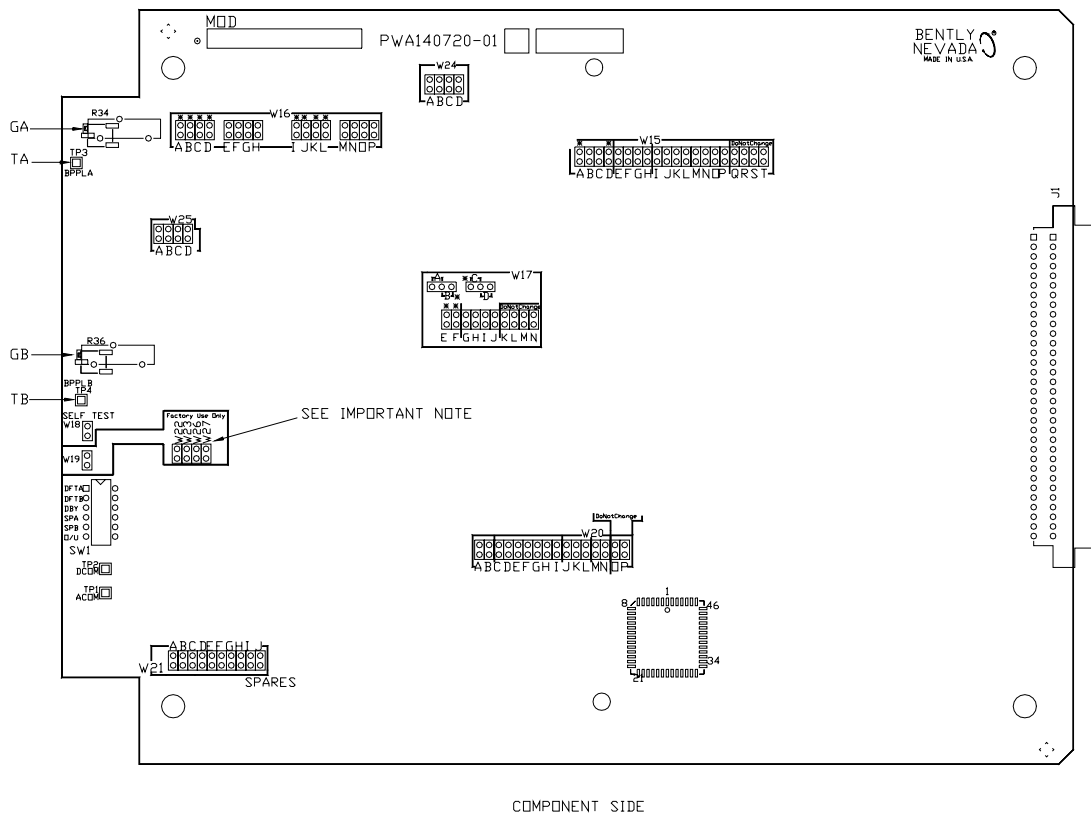

**Jumper Locations for PWA 140720-01.**

## 21.2 Main Board Option Settings

All monitor option jumpers for the Dual Vibration Monitor are on the Main Board. The following table lists these options and their jumper positions.

**Option Settings on Newer Version of the Main Board (Part Number 140720-01)**

OPTION	SETTING	JUMPER	
		INSTALL	REMOVE
<b>First Out</b>	Enabled *	-----	W20I
	Disabled	W20I	-----
<b>Alert Mode</b>	Latching *	-----	W20G
	Nonlatching	W20G	-----
<b>Danger Mode</b>	Latching *	-----	W20F
	Nonlatching	W20F	-----
<b>Danger Voting</b>	And Relay Drive	W20H	-----
	Or Relay Drive *	-----	W20H
<b>Danger Bypass Switch</b>	Enabled	W20C	-----
	Disabled *	-----	W20C
<b>Vibration Alarm Delay **</b>	0.1 s.	W20A	W20B
	1 s.	W20A,B	-----
	3 s. *	-----	W20A,B
	6 s.	W20B	W20A
<b>Gap Alarm</b>	Enabled	W20D	-----
	Disabled *	-----	W20D
<b>Recorder Clamping Mode +4 to 20 mA Rec. only</b>	NOT OK = 4 mA	-----	W17E, F
	NOT OK = 2 mA*	W17E, F	-----
<b>Corner Frequency Option</b>	60-36,000 RPM	W15B, C, W16E-H, M-P	W15A, D, W16A-D, I-L
	240-240,000 RPM*	W15A, D, W16A-D, I-L	W15B, C, W16E-H, M-P
* Standard configuration as shipped from factory.			
** Gap Alarm Delay is 6 s.			

## 21.3 Recorder Output Options

To set the recorder output, remove all jumpers from headers W17A, B, C, D, G, H, I, J. Install jumpers as specified in the following table.

**Recorder Output Options, W17**

Recorder Output	+4 to +20 mA *	+1 to +5 Vdc	0 to -10 Vdc
Jumper Settings	B, C	A, D	A, D, G, H, I, J

\* Standard Configuration as shipped from factory.

## 21.4 Gap Full Scale Range Options

To set the gap full-scale range option, remove jumpers W20E, J, K, L. Install jumpers specified in the following table.

**Gap Full Scale Range Options, W20**

Gap Full Scale Range	Install Jumpers
0 - 19 Vdc * (All transducers)	NONE
15 - 0 - 15 mils (7200 5 & 8 mm, 3300 8mm, RAM, 3300XL 8mm and 3000)	L **
25 - 0 - 25 mils (7200 5 & 8 & 11 & 14 mm, 3300 8mm, 16mm HTPS, 3300 XL 11mm, and 3300XL 8mm)	K**
50 - 0 - 50 mils (7200 11 & 14mm, 3300 16mm HTPS, 3300 XL 11mm)	K, L**
300 - 0 - 300 um (7200 5 & 8 mm, 3300 8 mm, RAM, 3300XL 8mm and 3000)	J**
600 - 0 - 600 um (7200 5 & 8 & 11 & 14mm, 3300 8mm, 16mm HTPS, 3300 XL 11mm, and 3300XL 8mm)	J, L**
1000 - 0 - 1000 um (7200 11 & 14mm and 3300 16mm HTPS, 3300 XL 11mm)	J, K**
* Standard Configuration as shipped from factory.	
** Install jumper W20E if external barriers are used with this gap full-scale range.	

## 21.5 Vibration Full Scale Range Options

To set the vibration full-scale range option, remove jumpers W15E-H, W24A-D, W25A-D. Install jumpers specified in the following table.

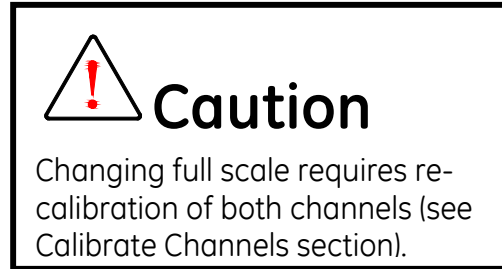

**Vibration Full Scale Range Options**

Vibration Full Scale Range		Install Jumpers		
		W15	W24	W25
-01	0 - 3 mil pp	E, G	A	A
-02	0 - 5 mil pp	E, G	C	C
-03	0 - 10 mil pp	E, G	A, D	A, D
-04	0 - 15 mil pp	E, G	A, C, D	A, C, D
-05	0 - 20 mil pp	F, H	A, D	A, D
-11	0 - 100 $\mu$ m pp	E, G	B	B
-12	0 - 150 $\mu$ m pp	F, H	A	A
-13	0 - 200 $\mu$ m pp	E, G	A, C	A, C
-14	0 - 400 $\mu$ m pp	F, H	A, C	A, C
-15	0 - 500 $\mu$ m pp	E, G	A, B, C, D	A, B, C, D

Replacement scales are included with the manual.

## 21.6 Transducer Input Options

To set the transducer input option, remove jumpers W15I, J, K, L, M, N, O, P / W20M, N. Install jumpers specified in following table.

**Transducer Input Options**

Transducer Input		Install Jumpers
-01	3300 8mm, 3300XL 8mm or 7200 5 & 8mm Proximator® Sensor (200 mV/mil)	W15I, J, M, N
-02 & -05	3000 or 3300 RAM Proximator® Sensor (200 mV/mil)	W15I, J, K, O W20M, N
-03	7200 11mm Proximator® Sensor (100 mV/mil)	W15L, P W20N
-04	3300 HTPS 16mm or 3300 XL 11mm or 7200 14mm Proximator® Sensor (100 mV/mil)	W15M, N W20M

## 21.7 Trip Multiply

The following jumpers control the Trip Multiply feature:

- W15Q, R, S, T
- W17K, L, M, N
- W20O, P

**Note**

These jumpers are labeled "Do Not Change" on the PWA because careful thought must be given to changing the Trip Multiply configuration. Alarm setpoints will be multiplied by 2 or 3.

If you want to change the Trip Multiply configuration, use the following table to change the appropriate jumpers:

1. Remove W15Q-T, W17K-N, W20O-P			
2. Install the following jumpers			
Configuration	Jumpers		
	W15	W17	W20
No Trip Multiply	Q, R, S, T	K, L, M, N	-----
2X Trip Multiply	R, T	L, N	P
3x Trip Multiply	-----	-----	O

# 22. Appendix B - Monitor Options for PWA 135305-01

## 22.1 Jumper Locations for 135305-01

This section shows the jumper configuration for **PWA 135305-01** only.

The Dual Vibration Monitor has several user-programmable options. The options can be changed by removing and installing jumpers on the main circuit board.

**IMPORTANT!**

W19, 22, and 23 are for factory use only and should not be changed. These jumpers are labeled "Factory Use Only" on the PWA.

For normal operation W19, W22, and W23 should be removed.

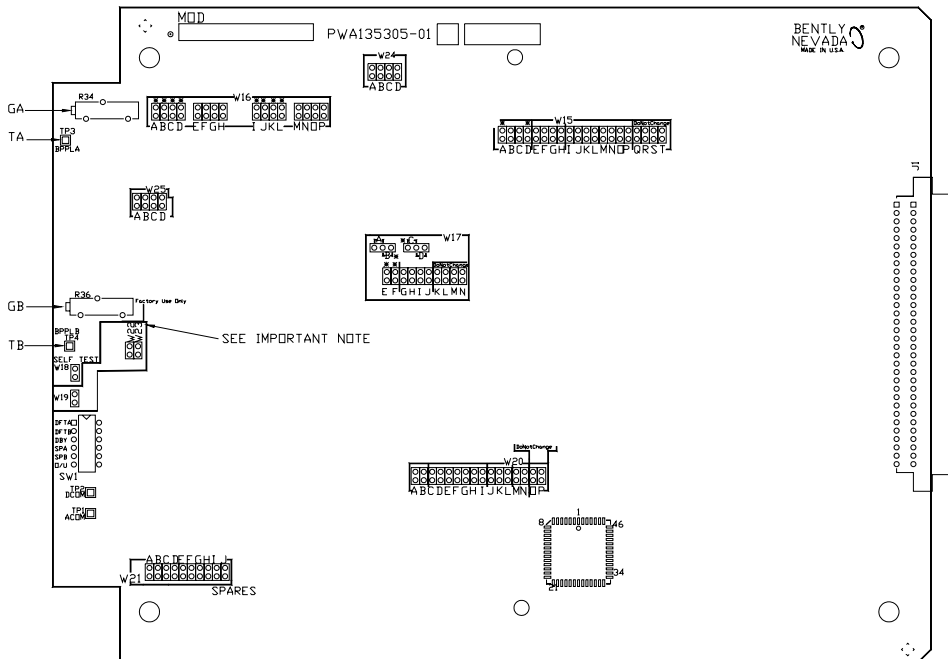

COMPONENT SIDE

**Jumper Locations on the Newer Version of the Main Circuit Board (Part Number 135305-01)**



## 22.2 Main Board Option Settings

All monitor option jumpers for the Dual Vibration Monitor are on the Main Board. The following table lists these options and their jumper positions.

**Option Settings on Newer Version of the Main Board (Part Number 135305-01)**

OPTION	SETTING	JUMPER	
		INSTALL	REMOVE
<b>First Out</b>	Enabled *	-----	W20I
	Disabled	W20I	-----
<b>Alert Mode</b>	Latching *	-----	W20G
	Nonlatching	W20G	-----
<b>Danger Mode</b>	Latching *	-----	W20F
	Nonlatching	W20F	-----
<b>Danger Voting</b>	And Relay Drive	W20H	-----
	Or Relay Drive *	-----	W20H
<b>Danger Bypass Switch</b>	Enabled	W20C	-----
	Disabled *	-----	W20C
<b>Vibration Alarm Delay **</b>	0.1 s.	W20A	W20B
	1 s.	W20A,B	-----
	3 s. *	-----	W20A,B
	6 s.	W20B	W20A
<b>Gap Alarm</b>	Enabled	W20D	-----
	Disabled *	-----	W20D
<b>Recorder Clamping Mode +4 to 20 mA Rec. only</b>	NOT OK = 4 mA	-----	W17E, F
	NOT OK = 2 mA*	W17E, F	-----
<b>Corner Frequency Option</b>	60-36,000 RPM	W15B, C, W16E-H, M-P	W15A, D, W16A-D, I-L
	240-240,000 RPM*	W15A, D, W16A-D, I-L	W15B, C, W16E-H, M-P
* Standard configuration as shipped from factory.			
** Gap Alarm Delay is 6 s.			

## 22.3 Recorder Output Options

To set the recorder output, remove all jumpers from headers W17A, B, C, D, G, H, I, J. Install jumpers as specified in the following table.

**Recorder Output Options, W17**

Recorder Output	+4 to +20 mA *	+1 to +5 Vdc	0 to -10 Vdc
Jumper Settings	B, C	A, D	A, D, G, H, I, J

\* Standard Configuration as shipped from factory.

## 22.4 Gap Full Scale Range Options

To set the gap full-scale range option, remove jumpers W20E, J, K, L. Install jumpers specified in the following table.

**Gap Full Scale Range Options, W20**

Gap Full Scale Range	Install Jumpers
0 - 19 Vdc * (All transducers)	NONE
15 - 0 - 15 mils (7200 5 & 8 mm, 3300 8mm, RAM, 3300XL 8mm and 3000)	L **
25 - 0 - 25 mils (7200 5 & 8 & 11 & 14 mm, 3300 8mm, 16mm HTPS, 3300 XL 11mm, and 3300XL 8mm)	K**
50 - 0 - 50 mils (7200 11 & 14mm, 3300 16mm HTPS, 3300 XL 11mm)	K, L**
300 - 0 - 300 um (7200 5 & 8 mm, 3300 8 mm, RAM, 3300XL 8mm and 3000)	J**
600 - 0 - 600 um (7200 5 & 8 & 11 & 14mm, 3300 8mm, 16mm HTPS, 3300 XL 11mm, and 3300XL 8mm)	J, L**
1000 - 0 - 1000 um (7200 11 & 14mm and 3300 16mm HTPS, 3300 XL 11mm)	J, K**

\* Standard Configuration as shipped from factory.  
\*\* Install jumper W20E if external barriers are used with this gap full-scale range.

## 22.5 Vibration Full Scale Range Options

To set the vibration full-scale range option, remove jumpers W15E-H, W24A-D, W25A-D. Install jumpers specified in the following table.

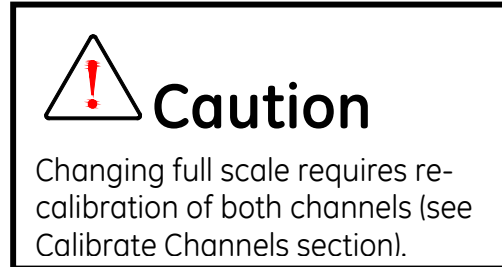

**Vibration Full Scale Range Options**

Vibration Full Scale Range		Install Jumpers		
		W15	W24	W25
-01	0 - 3 mil pp	E, G	A	A
-02	0 - 5 mil pp	E, G	C	C
-03	0 - 10 mil pp	E, G	A, D	A, D
-04	0 - 15 mil pp	E, G	A, C, D	A, C, D
-05	0 - 20 mil pp	F, H	A, D	A, D
-11	0 - 100 $\mu\text{m}$ pp	E, G	B	B
-12	0 - 150 $\mu\text{m}$ pp	F, H	A	A
-13	0 - 200 $\mu\text{m}$ pp	E, G	A, C	A, C
-14	0 - 400 $\mu\text{m}$ pp	F, H	A, C	A, C
-15	0 - 500 $\mu\text{m}$ pp	E, G	A, B, C, D	A, B, C, D

Replacement scales are included with the manual.

## 22.6 Transducer Input Options

To set the transducer input option, remove jumpers W15I, J, K, L, M, N, O, P / W20M, N. Install jumpers specified in following table.

**Transducer Input Options**

22.6.1.1 Transducer Input		22.6.1.2 Install Jumpers
-01	3300 8mm, 3300XL 8mm or 7200 5mm & 8mm Proximator® Sensor (200 mV/mil)	W15I, J, M, N
-02 & -05	3000 or 3300 RAM Proximator® Sensor (200 mV/mil)	W15I, J, K, O W20M, N
-03	7200 11mm Proximator® Sensor (100 mV/mil)	W15L, P W20N
-04	3300 HTPS 16mm or 3300 XL 11mm or 7200 14mm Proximator® Sensor (100 mV/mil)	W15M, N W20M

## 22.7 Trip Multiply

The following jumpers control the Trip Multiply feature:

- W15Q, R, S, T
- W17K, L, M, N
- W200, P

**Note**

These jumpers are labeled "Do Not Change" on the PWA because careful thought must be given to changing the Trip Multiply configuration. Alarm setpoints will be multiplied by 2 or 3.

If you want to change the Trip Multiply configuration, use the following table to change the appropriate jumpers:

1. Remove W15Q-T, W17K-N, W20O-P
2. Install the following jumpers

Configuration	Jumpers		
	<b>W15</b>	<b>W17</b>	<b>W20</b>
No Trip Multiply	Q, R, S, T	K, L, M, N	-----
2X Trip Multiply	R, T	L, N	P
3x Trip Multiply	-----	-----	O

# 23. Appendix C – Monitor Options for PWA 86739-01

## 23.1 Jumper locations for 86739-01.

This section shows the jumper configuration for the **86739-01 PWA only**.

The Dual Vibration Monitor has several user-programmable options. The options can be changed by removing and installing jumpers on the main circuit board.

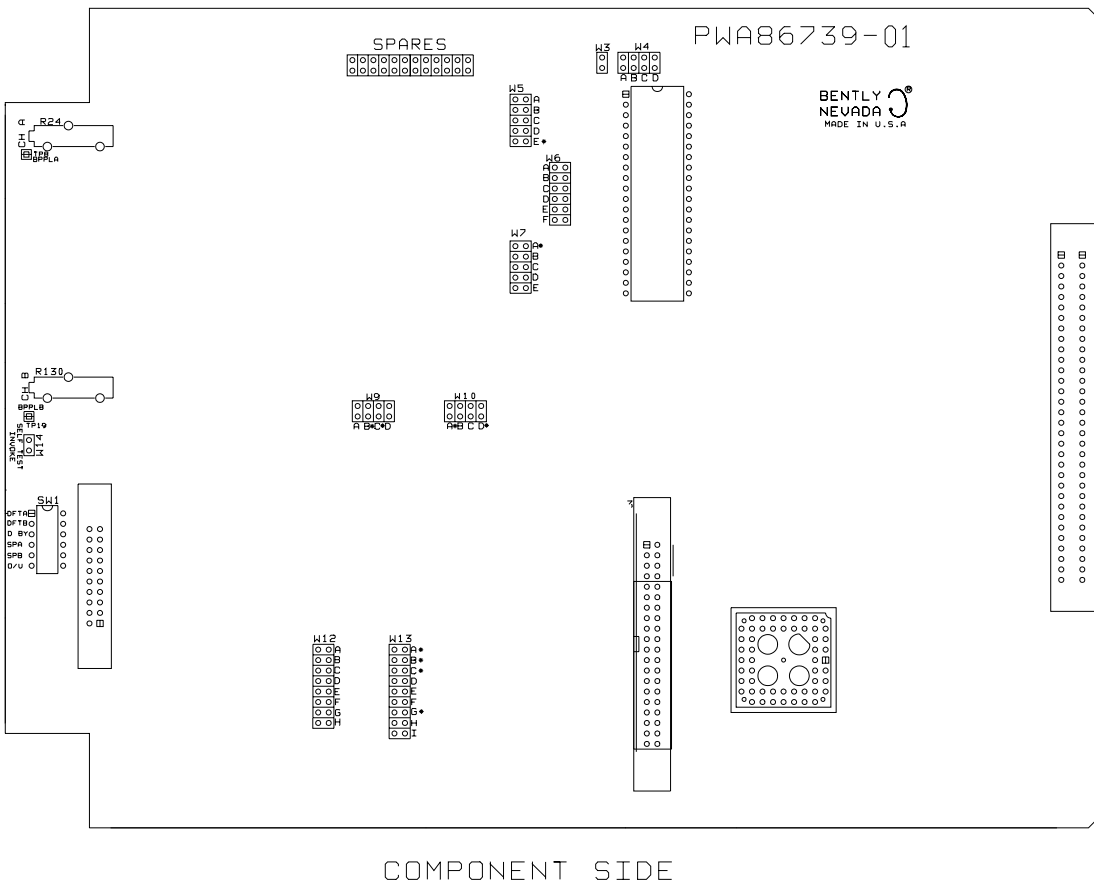

**Jumper Locations on the Original Version of the Main Circuit Board (Part Number 86739-01)**

## 23.2 Main Board Option Settings

All monitor option jumpers for the Dual Vibration Monitor are on the Main Board. The following table lists these options and their jumper positions.

### Option Settings on Older Version of the Main Board (Part Number 86739-01)

OPTION	SETTING	JUMPER	
		INSTALL	REMOVE
<b>First Out</b>	Enabled *	W13G	-----
	Disabled	-----	W13G
<b>Alert Mode</b>	Latching *	W13B	-----
	Nonlatching	-----	W13B
<b>Danger Mode</b>	Latching *	W13A	-----
	Nonlatching	-----	W13A
<b>Danger Voting</b>	And Relay Drive	W13F	-----
	Or Relay Drive *	-----	W13F
<b>Danger Bypass Switch</b>	Enabled	W13E	-----
	Disabled *	-----	W13E
<b>Vibration Alarm Delay **</b>	0.1 s.	-----	W13C, D
	1 s.	W13D	W13C
	3 s. *	W13C	W13D
	6 s.	W13C, D	-----
<b>Gap Alarm</b>	Enabled	W12A	-----
	Disabled *	-----	W12A
<b>Recorder Clamping Mode +4 to 20 mA Rec. only</b>	NOT OK = 4 mA	-----	W9B, W10D
	NOT OK = 2 mA*	W9B, W10D	-----
<b>Corner Frequency Option</b>	60-36,000 RPM	W3, W5D, W7B	W5E, W7A
	240-240,000 RPM*	W5E, W7A	W3, W5D, W7B

\* Standard configuration as shipped from factory.

\*\* Gap Alarm Delay is 6 s.

## 23.3 Recorder Output Options

To set the recorder output, remove all jumpers from headers W8A, W8B, W9A, W9C, W9D, W10A-C, W11A, W11B. Install jumpers as specified in the following table.

### Recorder Output Options

Recorder Output	+4 to +20 mA *	+1 to +5 Vdc	0 to -10 Vdc
<b>Jumper Settings</b>	W8A, W9C, W10A, W11A	W8B, W9D, W10B, W11B	W8B, W9A, W9C, W10A, W10C, W11B
* Standard Configuration as shipped from factory.			

## 23.4 Gap Full Scale Range Options

To set the gap full-scale range option, remove jumpers W12B-D, W12G. Install jumpers specified in the following table.

### Gap Full Scale Range Options

Gap Full Scale Range	Install Jumpers
0 - 19 Vdc * (All transducers)	NJ
15 - 0 - 15 mils (7200 5 & 8mm, 3300 8mm, RAM, 3300XL 8mm and 3000)	W12D **
25 - 0 - 25 mils (7200 5 & 8 & 11 & 14mm, 3300 8mm, 16mm HTPS, 3300 XL 11mm, and 3300XL 8mm)	W12C**
50 - 0 - 50 mils (7200 11 & 14mm, 3300 16mm HTPS, 3300 XL 11mm)	W12C, D**
300 - 0 - 300 um (7200 5 & 8mm, 3300 8mm, RAM, 3300XL 8mm and 3000)	W12B**
600 - 0 - 600 um (7200 5 & 8 & 11 & 14mm, 3300 8mm, 16mm HTPS, 3300 XL 11mm, and 3300XL 8mm)	W12B, D**
1000 - 0 - 1000 um (7200 11 & 14mm, 3300 16mm HTPS, 3300 XL 11mm)	W12B, C**
* Standard Configuration as shipped from factory.	
** If external barriers are used with this gap full-scale range, install jumper W12G also.	



## 23.5 Vibration Full Scale Range Options

To set the vibration full-scale range option, remove jumpers W4A-D, W5A, W5B, W7D-E. Install jumpers specified in the following table.

### Vibration Full Scale Range Options

Vibration Full Scale Range		Install Jumpers
-01	0 – 3 mil pp	W4A, W4C, W5B, W7D
-02	0 – 5 mil pp	W4A, W5B, W7D
-03	0 – 10 mil pp	W4A, W5A, W7E
-04	0 – 15 mil pp	W4B, W4C, W4D, W5A, W7E
-05	0 – 20 mil pp	W4B, W4D, W5A, W7E
-11	0 – 100 $\mu$ m pp	W4A, W4D, W5B, W7D
-12	0 – 150 $\mu$ m pp	W4A, W4C, W5A, W7E
-13	0 – 200 $\mu$ m pp	W4A, W4D, W5A, W7E
-14	0 – 400 $\mu$ m pp	W4B, W4C, W5A, W7E
-15	0 – 500 $\mu$ m pp	W4B, W4D, W5A, W7E

## 23.6 Transducer Input Options

To set the transducer input option, remove jumpers W5C, W6A-F, W7C, W12E, W12F. Install jumpers specified in following table.

### Transducer Input Options

Transducer Input		Install Jumpers
-01	7200 5 & 8mm or 3300 8 mm, 3300XL 8mm Proximitor Sensor (200 mV/mil)	W5C, W6C, W6D, W7C
-02 & -05	3000 or 3300 RAM Proximitor Sensor  <b>(200 mV/mil)</b>	W5C, W6A, W6E, W7C, W12E, W12F
-03	7200 11mm Proximitor Sensor (100 mV/mil)	W6B, W6F, W12F
-04	7200 14mm, 3300 XL 11mm or 3300 16mm HTPS Proximitor Sensor (100 mV/mil)	W6C, W6D, W12E

## **23.7 Trip Multiply**

Trip multiply requires the installation of option jumpers (W13I or W13H) and removal of components. To change the trip multiply option, contact Bently Nevada Product Service.

## 24. Recommended Spare Parts

QTY PER MONITOR	DESCRIPTION	REPLACEMENT PART NUMBER
1	FRONT PANEL ASSEMBLY	Order complete catalog number *
1	MONITOR CIRCUIT ASSEMBLY	
1	SPARE JUMPERS (100 PIECES)	88706-01
1	SIGNAL INPUT RELAY MODULE	
	NO RELAY	81544-01 *
	EPOXY SEALED RELAY	81545-01 *
	HERMETICALLY SEALED RELAY	81546-01 *
	QUAD EPOXY SEALED	84152-01 *
	NO RELAY WITH INTERNAL BARRIERS	88984 -03 *
	EPOXY SEALED RELAY WITH INTERNAL BARRIERS	88984-02 *
	HERMETICALLY SEALED RELAY WITH INTERNAL BARRIERS	88984-01 *

\* To order replacement parts, specify the complete catalog number, 3300/16 - AXX - BXX - CXX - DXX - EXX - FXX, and the replacement part number.

If the monitor has been modified, specify the modification number on the parts

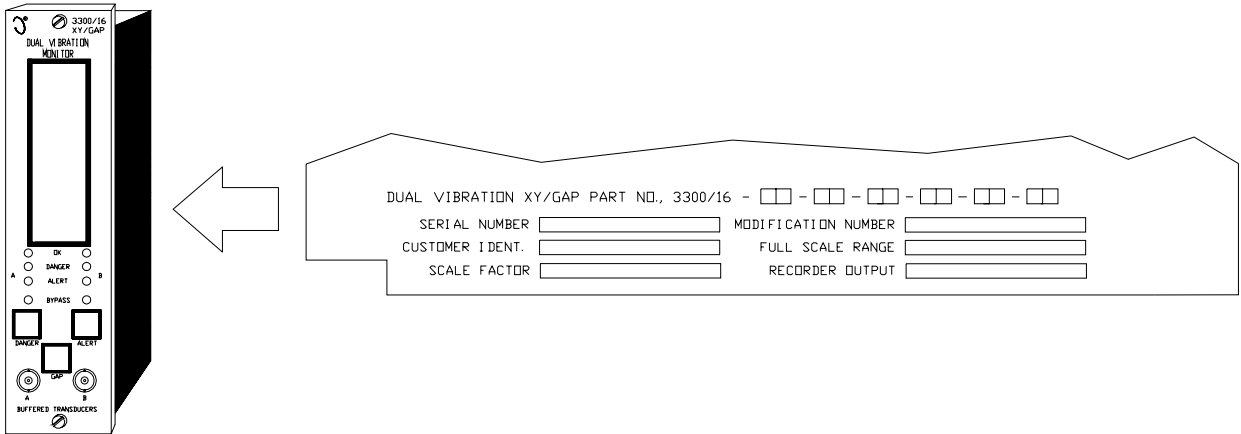

order. User must set programmable options (reference section **21, 22, or 23** of this manual). If in doubt about the part number, call your local sales representative before ordering.

## 25. Index

Alarm.....	3
Alarm Setpoints.....	23, 44
Alert LED .....	9, 28, 30, 31
Alert Setpoints.....	12, 23
Approvals .....	20
Barriers.....	18, 20, 39
Buffered Output .....	4
Bypass LED .....	3, 8, 25, 26, 40, 41
Calibrate Channels .....	35
Channel Bypass.....	3, 4, 25, 31, 34, 37
Common Relay OR Bus.....	18
Danger Bypass .....	4, 8, 26, 29, 31, 34, 37, 46, 52, 58
Danger LED .....	10, 28, 29
Danger Setpoints.....	13, 23
Danger Voting.....	10, 46, 52, 58
Dual Relay Module .....	18
Error Codes.....	41, 44
Errors.....	5, 40, 41
External Barriers .....	21, 36, 39, 47, 54, 59
First Out .....	4, 9, 10, 28, 29, 30, 46, 52, 58
Flashing LED .....	3, 7, 8, 28, 29, 30, 33, 34, 37, 40, 41, 42, 43
Full Scale Range Options .....	20, 48, 54, 60
Gap Alarm.....	4, 30, 46, 52, 58
Gap Alert Setpoint Adjust.....	24
Gap Full Scale Range Options.....	39, 47, 53, 59
Gap Voltage .....	3, 11
Input Module .....	17, 18
Internal Barriers .....	62
Jumper Locations .....	45, 51, 57
Latching Relays.....	4, 29, 31, 46, 52, 58
LED .....	7, 28, 33, 34
Main Board Options.....	46, 52, 58
Monitor Options .....	20, 44, 45, 51, 57
Monitor Removal .....	14, 15, 16
Non-Latching Relays.....	4, 29, 31, 46, 52, 58
OK LED.....	3, 7, 25, 32, 33, 34, 37, 40, 41, 42, 43
OK Limits .....	34, 39
OK Relay .....	3
Probe Gap Voltage.....	3
PWA Number .....	21
Quad Relay Module .....	18
Radial Vibration.....	3
Recorder Clamping.....	5, 46, 52, 58

## 3300/16 Dual Vibration Monitor Operation Manual

---

Recorder Outputs .....	5, 47, 53, 59
Relays .....	4, 18, 20, 62
Replacement Parts .....	62
Reset .....	3, 4, 7, 28, 29, 30, 31, 33, 34, 37, 43
Self Test.....	5, 40, 44
Setpoint Values.....	12
Signal Input Module .....	17, 62
Test Alarms.....	27
Test OK Limits.....	32
Timed OK/Channel Defeat.....	3, 8, 28, 42
Transducer Input Options.....	49, 55, 60
Transducer Power.....	21
Transducer Scale Factor .....	36
Trip Multiply.....	4, 8, 20, 29, 37, 49, 55, 61
Vibration .....	3, 6, 9, 10
Zero Position.....	4
Zero Position Adjust.....	38