

VersaMax Nano and Micro	9.3	RTD I/O Modules	9.67
Nano PLCs	9.5	Strain Gage I/O Modules.....	9.68
Micro PLCs	9.6	Temperature Control Modules	9.69
Discrete Expansion Selection Guide	9.14	Thermocouple I/O Modules	9.70
Discrete Expansion Units	9.15	Network and Distributed I/O Systems	9.72
Analog Expansion Selection Guide.....	9.21	Serial Communications Modules.....	9.75
Analog Expansion Units	9.22	Power Measurement Modules	9.76
DataPanels Operator Interfaces	9.25	Pneumatic Module	9.77
Communications Options	9.26	Programmable Coprocessor Modules	9.78
Portable Program Download Device (PPDD).....	9.28	Motion Modules	9.79
Accessories; Power Supplies; Cables.....	9.30	Remote Expansion Modules	9.81
Starter Kits.....	9.31	Accessories; Cables; Terminal Blocks	9.82
Configuration Guidelines; Typical Applications	9.32	Configuration Guidelines; Typical Applications	9.84
Durus	9.34	PACSystems RX7i Specialty Controller	9.85
AC Models	9.35	CPUs.....	9.86
DC Models	9.37	Racks	9.88
Discrete Expansion Units	9.41	Power Supplies.....	9.89
Analog Expansion Units	9.42	I/O Interface Modules	9.90
Communications Options	9.43	Communications Modules.....	9.91
Software	9.44	Accessories and Cables	9.92
Accessories; Starter Kits.....	9.45		
Configuration Guidelines; Typical Applications	9.46	Genius Block I/O	9.93
 		AC Discrete I/O Modules.....	9.94
Series 90-30	9.47	DC Discrete I/O Modules.....	9.95
CPUs.....	9.48	Analog Input Modules	9.97
Baseplates	9.51	Analog Output Modules	9.98
Power Supplies.....	9.52	Analog Mixed Modules	9.99
Discrete I/O Modules (Input).....	9.54	RTD and Thermocouple Modules.....	9.100
Analog I/O Modules (Input)	9.57	High Speed Counter	9.101
Discrete I/O Modules (Output)	9.59	PowerTRAC Monitoring Module.....	9.102
Analog I/O Modules (Output)	9.64	Accessories, Cables, Hand Held Monitor	9.103
Millivolt I/O Modules.....	9.66	Configuration Guidelines; Typical Applications	9.104

VersaMax Nano and Micro Controllers

Don't let size fool you. Although they are easy on valuable panel space, the VersaMax Nano and Micro PLCs are big on features. For high-volume applications where cost and fast processor speeds are an issue, the VersaMax Nano is the PLC of choice. For additional functionality, the modular VersaMax Micro offers the features and the flexibility to match application needs in such industries as food processing, chemicals, packaging, water and wastewater, construction equipment and plastics.

For tight spaces, the VersaMax Nano PLC is the perfect solution. Thanks to its all-in-one construction, installation is a breeze. All you have to do is snap it onto a DIN-rail or screw it into a panel. With the VersaMax Nano, you save on initial as well as life cycle costs.

The small-footprint VersaMax Micro PLC offers the flexibility of modular design and a variety of built-in features, including up to 64 I/O points (expandable to 170 I/O points), fast cycle times, a robust instruction set and extensive memory that multiplies your programming options.

Machine Edition

Machine Edition is an advanced software environment for the development and maintenance of machine level automation. Visualization, motion control, and execution logic are developed with a single programmer.

Publication Reference Chart

GFK-1645	VersaMax Micro PLCs and Nano PLCs User's Manual
IC690CDU002	InfoLink for PLC CD-ROM



Nano PLCs, page 9.5



Micro PLCs, pages 9.6-9.13



Expansion Units, pages 9.14-9.24



DataPanel Operator Interfaces, page 9.25



Communications Options, pages 9.26-9.27



Portable Program Download Device (PPDD), pages 9.28-9.29

Accessories, pages 9.30-9.31

Configuration Guidelines, pages 9.32-9.33

VersaMax Nano and Micro Selection Guide

Features	Nano 10	Micro 14	Micro 23	Micro 28	Micro 20	Micro 40	Micro 64
Built-in Discrete I/O	6 in/ 4out	8 in/ 6 out	13 in/10 out	16 in/12 out	12 in/8 out	24 in/16 out	40 in/24 out
Built-in Analog I/O	1 on some models	none	2 in/ 1 out	none	none	none	none
I/O Expansion Units	none	Up to 4 units	Up to 4 units	Up to 4 units	Up to 4 units	Up to 4 units	Up to 4 units
Logic Memory (Words)	2K	9K	9K	9K	24K	24K	24K
Data Storage (Words)	256	256	2K	2K	32K	32K	32K
Scan Time (msec/K)	1.3 msec	1.1 msec	1.1 msec	1.1 msec	1.1 msec	1.1 msec	1.1 msec
Battery Backed RAM	Super Cap only	Super Cap only	Yes and Super Cap	Yes and Super Cap	Yes and Super Cap	Yes and Super Cap	Yes and Super Cap
Real Time Clock	none	none	Yes, Included	Yes, Included	Yes, Included	Yes, Included	Yes, Included
Ports Available	1 RS-232	1 RS-232	1 RS-232 and 1 RS-485	1 RS-232 and 1 RS-485	1 RS-232 and second port optional RS-232, RS-485, USB or Ethernet	1 RS-232 and second port optional RS-232, RS-485, USB or Ethernet	1 RS-232 and second port optional RS-232, RS-485, USB or Ethernet
Ethernet Option	Yes, VersaMax SE	Yes, VersaMax SE	Yes, VersaMax SE	Yes, VersaMax SE	Yes on second port	Yes on second port	Yes on second port
High Speed Counter	Up to 4 at 10Khz (16 bit)	Up to 4 at 10Khz (16 bit)	Up to 4 at 10Khz (16 bit)	Up to 4 at 10Khz (16 bit)	Up to 4 at 100Khz (32 bit)	Up to 4 at 100Khz (32 bit)	Up to 4 at 100Khz (32 bit)
Pulse Train/PWM	Up to 4 at 5Khz (16 bit)	Up to 4 at 5Khz (16 bit)	Up to 4 at 5Khz (16 bit)	Up to 4 at 5Khz (16 bit)	Up to 4 at 65Khz (32 bit)	Up to 4 at 65Khz (32 bit)	Up to 4 at 65Khz (32 bit)
Motion Commands	N/A	N/A	N/A	N/A	Find Home, Go Home, Jog, Ramp, Blended Move (4 Consecutive Moves)	Find Home, Go Home, Jog, Ramp, Blended Move (4 Consecutive Moves)	Find Home, Go Home, Jog, Ramp, Blended Move (4 Consecutive Moves)
Write Register Values to Internal Flash	No	Yes	Yes	Yes	Yes	Yes	Yes
On Line Program Support	No	No	No	No	Yes with Firmware 3.9 & Hardware revision B	Yes with Firmware 3.9	Yes with Firmware 3.9

Powerful Instruction Set

Bit Operation Functions

- Logic AND, Logic OR
- Exclusive OR, Logical Invert
- Shift Right/Left
- Rotate Right/Left
- Bit Test/Set/Clear
- Masked Compare
- Bit Position
- Bit Sequencer

Control Functions

- Do I/O
- Call
- End
- Subroutines
- Comments
- Master Control Relay
- Service Request
- PID

Table Functions

- Array Move
- Search

Data Move Functions

- Move
- Block Move
- Block Clear
- Shift Register
- Communications Request
 - Motion Moves
 - High Speed Counter
 - Serial Read/Write
 - Modbus Master

Conversion Functions

- BCD- 4
- Signed Integer
- Double Precision Signed Integer
- Real
- Real to Word
- Truncate Real Number

Math and Numerical Functions

- +, -, x, /
- Modulo division
- Scaling
- Square Root
- Trigonometric Functions
- Logarithmic/Exponential
- Convert Radians

Relation Functions

- Equal
- Not Equal
- Greater Than
- Less Than
- Greater or Equal
- Less or Equal
- Range

Relay Functions

- Contacts, Coils
- Fault and No Fault Contacts
- Alarm Contacts

Timer and Counters

- Time-tick Contacts
- On-delay Stopwatch timer
- On-delay timer
- Off-delay timer
- Up Counter
- Down Counter

Nano 10 PLCs



The palm-sized VersaMax Nano PLC is highly compact, with an all-in-one construction that saves panel space. Installation is a breeze: simply snap it onto a DIN-rail or mount it on a panel. Because it gives you more capabilities in a smaller, less expensive package, the Nano PLC is ideal for high-volume applications that require low cost, compact size, and fast processor speeds. The Nano decreases your life-cycle costs as well, with easy installation and long-term reliability.

	IC200NAL110	IC200NAL211	IC200NDD010	IC200NDD101	IC200NDR001	IC200NDR010
Product Name	10 point (6) 12 VDC In, (1) Analog Voltage In, (4) Relay Out, 12 VDC Powered	10 point (6) 24 VDC In, (1) Analog Voltage In, (4) Relay Out, 24 VDC Powered	10 point (6) 12 VDC In, (4) 12 VDC Out, 12 VDC Powered	10 point (6) 24 VDC In, (4) 24 VDC Out, 24 VDC Powered	10 point (6) 24 VDC In, (4) Relay Out, 24 VDC Powered	10 point (6) 12 VDC In, (4) Relay Out, 12 VDC Powered
Lifecycle Status	Mature	Mature	Mature	Mature	Mature	Mature
Number of Discrete Inputs/Outputs	6 In / 4 Out (Non Expandable)	6 In / 4 Out (Non Expandable)	6 In / 4 Out (Non Expandable)	6 In / 4 Out (Non Expandable)	6 In / 4 Out (Non Expandable)	6 In / 4 Out (Non Expandable)
Number of Analog Inputs/Outputs	1 In	1 In	N/A	N/A	N/A	N/A
Physical I/O Maximum	10	10	10	10	10	10
User Program Logic Memory (Words)	2 K	2 K	2 K	2 K	2 K	2 K
Registers (Words)	256	256	256	256	256	256
Analog Pots for Data Adjustment	Yes, 2	Yes, 2	Yes, 2	Yes, 2	Yes, 2	Yes, 2
Serial Port Connector Type	RJ-45 (RS-232)	RJ-45 (RS-232)	RJ-45 (RS-232)	RJ-45 (RS-232)	RJ-45 (RS-232)	RJ-45 (RS-232)
Protocols	SNP, SNP X (Breakless) RTU Slave (2 and 4 wire RTU Slave). Serial Read and Write	SNP, SNP X (Breakless) RTU Slave (2 and 4 wire RTU Slave). Serial Read and Write	SNP, SNP X (Breakless) RTU Slave (2 and 4 wire RTU Slave). Serial Read and Write	SNP, SNP X (Breakless) RTU Slave (2 and 4 wire RTU Slave). Serial Read and Write	SNP, SNP X (Breakless) RTU Slave (2 and 4 wire RTU Slave). Serial Read and Write	SNP, SNP X (Breakless) RTU Slave (2 and 4 wire RTU Slave). Serial Read and Write
Power Voltage	12 VDC	24 VDC	12 VDC	24 VDC	24 VDC	12 VDC
Input Power Supply Rating	3 watts internal	3 watts internal	3 watts internal	3 watts internal	3 watts internal	3 watts internal
Input Device Voltage	12 VDC	24 VDC	12 VDC	24 VDC	24 VDC	12 VDC
Maximum Type A and B Counters	2 Type A and 1 Type B @ 10Khz (16 bit)	2 Type A and 1 Type B @ 10Khz (16 bit)	2 Type A and 1 Type B @ 10Khz (16 bit)	2 Type A and 1 Type B @ 10Khz (16 bit)	2 Type A and 1 Type B @ 10Khz (16 bit)	2 Type A and 1 Type B @ 10Khz (16 bit)
Analog Input Ranges	0 to 10 VDC (8 bit)	0 to 10 VDC (8 bit)	N/A	N/A	N/A	N/A
Output Control Voltage	Relay Out	Relay Out	12 VDC	24 VDC	Relay Out	Relay Out
Relay Maximum Resistive Load Rating	2 Amps at 5 VDC and 240 VAC	2 Amps at 5 VDC and 240 VAC	N/A	N/A	2 Amps at 5 VDC and 240 VAC	2 Amps at 5 VDC and 240 VAC
Maximum Number of PWM/Pulse Outputs	0	0	3 @ 5Khz (16 bit)	3 @ 5Khz (16 bit)	0	0
Dimensions (W x H x D) mm	75 x 80 x 47	75 x 80 x 47	75 x 80 x 47	75 x 80 x 47	75 x 80 x 47	75 x 80 x 47
Operating Temperature	0°C to +55°C	0°C to +55°C	0°C to +55°C	0°C to +55°C	0°C to +55°C	0°C to +55°C
Programming Software	VersaPro 2.0 or greater, Machine Edition Logic Developer	VersaPro 2.0 or greater, Machine Edition Logic Developer	VersaPro 1.1 or greater, Machine Edition Logic Developer	VersaPro 1.1 or greater, Machine Edition Logic Developer	VersaPro 1.1 or greater, Machine Edition Logic Developer	VersaPro 1.1 or greater, Machine Edition Logic Developer
Portable Memory Module Support	No	No	No	No	No	No



Micro 14 PLCs

The Micro 14 PLC is big on features; from up to 14 I/O built-in (expandable to 126 I/O) points to fast cycle times, robust instruction set, and generous memory to allow more flexible programming. And it's all packaged in a sturdy modular design for easy access and long-term durability. This all-in-one PLC gives you everything you need to control a wide variety of applications.

	IC200UAA003	IC200UAR014	IC200UDD104	IC200UDD112
Product Name	14 point (8) 120 VAC In, (6) 120 VAC Out, 120/240 VAC Powered	14 point, (8) 120 VAC In, (6) Relay Out, 120/240 VAC Powered	14 point (8) 24 VDC In, (6) 12/24 VDC Out, (2) @ 1.0 A, (4) @ 0.5 A, 24 VDC Powered	14 point (8) 12 VDC In, (6) 12 VDC Out, 0.7 A, 12 VDC Powered
Lifecycle Status	Active	Active	Active	Active
Number of Discrete Inputs/Outputs	8 In / 6 Out (Supports 4 Expansion Units)	8 In / 6 Out (Supports 4 Expansion Units)	8 In / 6 Out (Supports 4 Expansion Units)	8 In / 6 Out (Supports 4 Expansion Units)
Number of Analog Inputs/Outputs	Supports up to 4 analog expansion units (16 analog in/ 8 analog out)	Supports up to 4 analog expansion units (16 analog in/ 8 analog out)	Supports up to 4 analog expansion units (16 analog in/ 8 analog out)	Supports up to 4 analog expansion units (16 analog in/ 8 analog out)
Physical I/O Maximum	126	126	126	126
User Program Logic Memory (Words)	9 K	9 K	9 K	9 K
Registers (Words)	256	256	256	256
Analog Pots for Data Adjustment	Yes, 2	Yes, 2	Yes, 2	Yes, 2
Serial Port Connector Type	RJ-45 (RS-232)	RJ-45 (RS-232)	RJ-45 (RS-232)	RJ-45 (RS-232)
Protocols	SNP, SNP X (Breakless) RTU Slave (2 and 4 wire RTU Slave). Serial Read and Write	SNP, SNP X (Breakless) RTU Slave (2 and 4 wire RTU Slave). Serial Read and Write	SNP, SNP X (Breakless) RTU Slave (2 and 4 wire RTU Slave). Serial Read and Write	SNP, SNP X (Breakless) RTU Slave (2 and 4 wire RTU Slave). Serial Read and Write
Power Voltage	120/240 VAC	120/240 VAC	24 VDC	12 VDC
Input Power Supply Rating	11 VA	11 VA	4 Watts	3 Watts
24 VDC User Power for Sensors	N/A	200 mA	200 mA	200 mA
Input Device Voltage	120 VAC	120 VAC	24 VDC	12 VDC
Maximum Type A and B Counters	N/A	N/A	4 Type A and 1 Type B @ 10Khz (16 bit)	4 Type A and 1 Type B @ 10Khz (16 bit)
Output Control Voltage	120 VAC	N/A	24 VDC	12 VDC
Relay Maximum Resistive Load Rating	N/A	6 @ 2 Amps at 24 VDC and 240 VAC; 2 @10 Amps at 24 VDC and 240 VAC	N/A	N/A
Maximum Number of PWM/Pulse Outputs	N/A	N/A	4 @ 5Khz (16 bit)	4 @ 5Khz (16 bit)
Dimensions (W x H x D) mm	95 x 90 x 76	95 x 90 x 76	95 x 90 x 76	95 x 90 x 76
Programming Software	VersaPro 1.1 or greater, Machine Edition Logic Developer	VersaPro 1.1 or greater, Machine Edition Logic Developer	VersaPro 1.1 or greater, Machine Edition Logic Developer	VersaPro 1.1 or greater, Machine Edition Logic Developer
Portable Memory Module Support	No	No	No	No



Micro 14 PLCs

The Micro 14 PLC is big on features; from up to 14 I/O built-in (expandable to 126 I/O) points to fast cycle times, robust instruction set, and generous memory to allow more flexible programming. And it's all packaged in a sturdy modular design for easy access and long-term durability. This all-in-one PLC gives you everything you need to control a wide variety of applications.

	IC200UDR001	IC200UDR002	IC200UDR003
Product Name	14 point (8) 24 VDC In, (6) Relay Out, 120/240 VAC Powered	14 point (8) 24 VDC In, (6) Relay Out, 24 VDC Powered	14 point (8) 12 VDC In, (6) Relay Out, 12 VDC Powered
Lifecycle Status	Active	Active	Active
Number of Discrete Inputs/Outputs	8 In / 6 Out (Supports 4 Expansion Units)	8 In / 6 Out (Supports 4 Expansion Units)	8 In / 6 Out (Supports 4 Expansion Units)
Number of Analog Inputs/Outputs	Supports up to 4 analog expansion units (16 analog in/ 8 analog out)	Supports up to 4 analog expansion units (16 analog in/ 8 analog out)	Supports up to 4 analog expansion units (16 analog in/ 8 analog out)
Physical I/O Maximum	126	126	126
User Program Logic Memory (Words)	9 K	9 K	9 K
Registers (Words)	256	256	256
Analog Pots for Data Adjustment	Yes, 2	Yes, 2	Yes, 2
Serial Port Connector Type	RJ-45 (RS-232)	RJ-45 (RS-232)	RJ-45 (RS-232)
Protocols	SNP, SNP X (Breakless) RTU Slave (2 and 4 wire RTU Slave). Serial Read and Write	SNP, SNP X (Breakless) RTU Slave (2 and 4 wire RTU Slave). Serial Read and Write	SNP, SNP X (Breakless) RTU Slave (2 and 4 wire RTU Slave). Serial Read and Write
Power Voltage	120/240 VAC	24 VDC	12 VDC
Input Power Supply Rating	13 VA	4 Watts	3 Watts
24 VDC User Power for Sensors	200 mA	200 mA	200 mA
Input Device Voltage	24 VDC	24 VDC	12 VDC
Maximum Type A and B Counters	4 Type A and 1 Type B @ 10Khz (16 bit)	4 Type A and 1 Type B @ 10Khz (16 bit)	4 Type A and 1 Type B @ 10Khz (16 bit)
Output Control Voltage	Relay Out	Relay Out	Relay Out
Relay Maximum Resistive Load Rating	2 Amps at 24 VDC and 240 VAC	2 Amps at 24 VDC and 240 VAC	2 Amps at 24 VDC and 240 VAC
Maximum Number of PWM/Pulse Outputs	0	0	0
Dimensions (W x H x D) mm	95 x 90 x 76	95 x 90 x 76	95 x 90 x 76
Programming Software	VersaPro 1.1 or greater, Machine Edition Logic Developer	VersaPro 1.1 or greater, Machine Edition Logic Developer	VersaPro 1.1 or greater, Machine Edition Logic Developer
Portable Memory Module Support	No	No	No

Micro 23 PLCs



The Micro 23 PLC is big on features with 23 discrete I/O and two analog inputs and one analog output built-in (expandable to 135 I/O) points. The Micro 23 executes fast cycle times, robust instruction set, and generous memory to allow more flexible programming. And it's all packaged in a sturdy modular design for easy access and long-term durability.

	IC200UAL004	IC200UAL005	IC200UAL006
Product Name	23 point; (13) 12 VDC In, (10) Relay Out, (2) Analog In and (1) Analog Out, 12 VDC Powered.	23 point; (13) 24 VDC In, (9) Relay Out, (1) 24 VDC Out, (2) Analog In and (1) Analog Out, 24 VDC Powered.	23 point; (13) 24 VDC In, (9) Relay Out, (1) 24 VDC Out, (2) Analog In and (1) Analog Out, 120/240 VAC Powered.
Lifecycle Status	Active	Active	Active
Number of Discrete Inputs/Outputs	13 In / 10 Out (Supports 4 Expansion Units)	13 In / 10 Out (Supports 4 Expansion Units)	13 In / 10 Out (Supports 4 Expansion Units)
Number of Analog Inputs/Outputs	2 analog in / 1 analog out built-in and supports up to 4 analog expansion units (16 analog in/ 8 analog out)	2 analog in / 1 analog out built-in and supports up to 4 analog expansion units (16 analog in/ 8 analog out)	2 analog in / 1 analog out built-in and supports up to 4 analog expansion units (16 analog in/ 8 analog out)
Physical I/O Maximum	135	135	135
User Program Logic Memory (Words)	9 K	9 K	9 K
Registers (Words)	2 K	2 K	2 K
Analog Pots for Data Adjustment	Yes, 2	Yes, 2	Yes, 2
Serial Port Connector Type	RJ-45 (RS-232) port 1 and DB-15 (RS-485 on port 2)	RJ-45 (RS-232) port 1 and DB-15 (RS-485 on port 2)	RJ-45 (RS-232) port 1 and DB-15 (RS-485 on port 2)
Protocols	Port 1, SNP, SNP X (Breakless); Port 2, SNP, SNP X (Breakless), RTU Master and Slave (2 and 4 wire RTU Slave), SNP Master, Serial Read and Write	Port 1, SNP, SNP X (Breakless); Port 2, SNP, SNP X (Breakless), RTU Master and Slave (2 and 4 wire RTU Slave), SNP Master, Serial Read and Write	Port 1, SNP, SNP X (Breakless); Port 2, SNP, SNP X (Breakless), RTU Master and Slave (2 and 4 wire RTU Slave), SNP Master, Serial Read and Write
Power Voltage	12 VDC	24 VDC	120/240 VAC
Input Power Supply Rating	8 Watts	8 Watts	34 VA
24 VDC User Power for Sensors	200 mA	200 mA	200 mA
Input Device Voltage	12 VDC	24 VDC	24 VDC
Maximum Type A and B Counters	4 Type A and 1 Type B @ 10KHz (16 bit)	4 Type A and 1 Type B @ 10KHz (16 bit)	4 Type A and 1 Type B @ 10KHz (16 bit)
Analog Input Ranges	0 to 10 VDC (10.24V max.) 0 to 20 mA (20.5 mA max.) 4 to 20 mA (20.5 mA max.); 12 bit Resolution	0 to 10 VDC (10.24V max.) 0 to 20 mA (20.5 mA max.) 4 to 20 mA (20.5 mA max.); 12 bit Resolution	0 to 10 VDC (10.24V max.) 0 to 20 mA (20.5 mA max.) 4 to 20 mA (20.5 mA max.); 12 bit Resolution
Output Control Voltage	Relay Out	Relay Out	Relay Out
Relay Maximum Resistive Load Rating	2 Amps at 24 VDC and 240 VAC	2 Amps at 24 VDC and 240 VAC	2 Amps at 24 VDC and 240 VAC
Maximum Number of PWM/Pulse Outputs	N/A	1 @ 5KHz (16 bit)	1 @ 5KHz (16 bit)
Analog Output Ranges	0 to 10 VDC (10.24V max.) 0 to 20 mA (20.5 mA max.) 4 to 20 mA (20.5 mA max.); 12 bit Resolution	0 to 10 VDC (10.24V max.) 0 to 20 mA (20.5 mA max.) 4 to 20 mA (20.5 mA max.); 12 bit Resolution	0 to 10 VDC (10.24V max.) 0 to 20 mA (20.5 mA max.) 4 to 20 mA (20.5 mA max.); 12 bit Resolution
Dimensions (W x H x D) mm	150 x 90 x 76	150 x 90 x 76	150 x 90 x 76
Programming Software	VersaPro 1.1 or greater, Machine Edition Logic Developer	VersaPro 1.1 or greater, Machine Edition Logic Developer	VersaPro 1.1 or greater, Machine Edition Logic Developer
Portable Memory Module Support	No	No	No

Micro 28 PLC

The Micro 28 PLC is big on features with the built-in 28 I/O (expandable to 140 I/O) points to fast cycle times, two built-in serial ports, robust instruction set, and generous memory to allow more flexible programming. And it's all packaged in a sturdy modular design for easy access and long-term durability. This all-in-one PLC gives you everything you need to control a wide variety of applications.



	IC200UAA007	IC200UAR028	IC200UDD110	IC200UDD120
Product Name	28 point; (16) 120 VAC In, (12) 120 VAC Out, 120/240 VAC Powered.	28 point, (16) 120 VAC In, (12) Relay Out, 120/240 VAC Powered.	28 point; (16) 24 VDC In, (12) 24 VDC Out (6) @ 1.0 A, (6) @ 0.5 A, 24 VDC Powered.	28 point; (16) 24 VDC In, (12) 24 VDC Out (6) @ 1.0 A, (6) @ 0.5 A, 24 VDC Powered.
Lifecycle Status	Active	Active	Active	Active
Number of Discrete Inputs/Outputs	16 In / 12 Out (Supports 4 Expansion Units)	16 In / 12 Out (Supports 4 Expansion Units)	16 In / 12 Out (Supports 4 Expansion Units)	16 In / 12 Out (Supports 4 Expansion Units)
Number of Analog Inputs/Outputs	Supports up to 4 analog expansion units (16 analog in/ 8 analog out)	Supports up to 4 analog expansion units (16 analog in/ 8 analog out)	Supports up to 4 analog expansion units (16 analog in/ 8 analog out)	Supports up to 4 analog expansion units (16 analog in/ 8 analog out)
Physical I/O Maximum	140	140	140	140
User Program Logic Memory (Words)	9 K	9 K	9 K	9 K
Registers (Words)	2 K	2 K	2 K	2 K
Analog Pots for Data Adjustment	Yes, 2	Yes, 2	Yes, 2	Yes, 2
Serial Port Connector Type	RJ-45 (RS-232) port 1 and DB-15 (RS-485 on port 2)	RJ-45 (RS-232) port 1 and DB-15 (RS-485 on port 2)	RJ-45 (RS-232) port 1 and DB-15 (RS-485 on port 2)	RJ-45 (RS-232) port 1 and DB-15 (RS-485 on port 2)
Protocols	Port 1, SNP, SNP X (Breakless); Port 2, SNP, SNP X (Breakless), RTU Master and Slave (2 and 4 wire RTU Slave), SNP Master, Serial Read and Write	Port 1, SNP, SNP X (Breakless); Port 2, SNP, SNP X (Breakless), RTU Master and Slave (2 and 4 wire RTU Slave), SNP Master, Serial Read and Write	Port 1, SNP, SNP X (Breakless); Port 2, SNP, SNP X (Breakless), RTU Master and Slave (2 and 4 wire RTU Slave), SNP Master, Serial Read and Write	Port 1, SNP, SNP X (Breakless); Port 2, SNP, SNP X (Breakless), RTU Master and Slave (2 and 4 wire RTU Slave), SNP Master, Serial Read and Write
Power Voltage	120/240 VAC	120/240 VAC	24 VDC	24 VDC
Input Power Supply Rating	16 VA	16 VA	5 Watts	5 Watts
24 VDC User Power for Sensors	N/A	200 mA	200 mA	200 mA
Input Device Voltage	120 VAC	120 VAC	24 VDC	24 VDC
Maximum Type A and B Counters	N/A	N/A	4 Type A and 1 Type B @ 10Khz (16 bit)	4 Type A and 1 Type B @ 10Khz (16 bit)
Output Control Voltage	120 VAC	Relay Out	24 VDC	24 VDC ESCP, Self Healing, No External Fusing Required
Relay Maximum Resistive Load Rating	N/A	10 @ 2 Amps at 24 VDC and 240 VAC; 2 @ 10 Amps at 24 VDC and 240 VAC	N/A	N/A
Maximum Number of PWM/Pulse Outputs	N/A	N/A	4 @ 5Khz (16 bit)	4 @ 5Khz (16 bit)
Dimensions (W x H x D) mm	150 x 90 x 76	150 x 90 x 76	150 x 90 x 76	150 x 90 x 76
Programming Software	VersaPro 1.1 or greater, Machine Edition Logic Developer	VersaPro 1.1 or greater, Machine Edition Logic Developer	VersaPro 1.1 or greater, Machine Edition Logic Developer	VersaPro 1.1 or greater, Machine Edition Logic Developer
Portable Memory Module Support	No	No	No	No

Micro 28 PLC



The Micro 28 PLC is big on features with the built-in 28 I/O (expandable to 140 I/O) points to fast cycle times, two built-in serial ports, robust instruction set, and generous memory to allow more flexible programming. And it's all packaged in a sturdy modular design for easy access and long-term durability. This all-in-one PLC gives you everything you need to control a wide variety of applications.

	IC200UDD212	IC200UDR005	IC200UDR006	IC200UDR228	IC200UDR010
Product Name	28 point (16) 12 VDC In, (12) 12 VDC Out, 0.7A, 12 VDC Powered	28 point (16) 24 VDC In, (11) Relay Out, (1) 24 VDC Out, 120/240 VAC Powered	28 point (16) 12 VDC In, (12) Relay Out, 12 VDC Powered	28 point (16) 24 VDC In, (11) Relay Out, (1) 24 VDC Out, 12/24 VDC Powered	28 point (16) 24 VDC In, (11) Relay Out, (1) 24 VDC Out, 24 VDC Powered
Lifecycle Status	Active	Active	Active	Active	Active
Number of Discrete Inputs/Outputs	16 In / 12 Out (Supports 4 Expansion Units)	16 In / 12 Out (Supports 4 Expansion Units)	16 In / 12 Out (Supports 4 Expansion Units)	16 In / 12 Out (Supports 4 Expansion Units)	16 In / 12 Out (Supports 4 Expansion Units)
Number of Analog Inputs/Outputs	Supports up to 4 analog expansion units (16 analog in/ 8 analog out)	Supports up to 4 analog expansion units (16 analog in/ 8 analog out)	Supports up to 4 analog expansion units (16 analog in/ 8 analog out)	Supports up to 4 analog expansion units (16 analog in/ 8 analog out)	Supports up to 4 analog expansion units (16 analog in/ 8 analog out)
Physical I/O Maximum	140	140	140	140	140
User Program Logic Memory (Words)	9 K	9 K	9 K	9 K	9 K
Registers (Words)	2 K	2 K	2 K	2 K	2 K
Analog Pots for Data Adjustment	Yes, 2	Yes, 2	Yes, 2	Yes, 2	Yes, 2
Serial Port Connector Type	RJ-45 (RS-232) port 1 and DB-15 (RS-485 on port 2)	RJ-45 (RS-232) port 1 and DB-15 (RS-485 on port 2)	RJ-45 (RS-232) port 1 and DB-15 (RS-485 on port 2)	RJ-45 (RS-232) port 1 and DB-15 (RS-485 on port 2)	RJ-45 (RS-232) port 1 and DB-15 (RS-485 on port 2)
Protocols	Port 1, SNP, SNP X (Breakless); Port 2, SNP, SNP X (Breakless), RTU Master and Slave (2 and 4 wire RTU Slave), SNP Master, Serial Read and Write	Port 1, SNP, SNP X (Breakless); Port 2, SNP, SNP X (Breakless), RTU Master and Slave (2 and 4 wire RTU Slave), SNP Master, Serial Read and Write	Port 1, SNP, SNP X (Breakless); Port 2, SNP, SNP X (Breakless), RTU Master and Slave (2 and 4 wire RTU Slave), SNP Master, Serial Read and Write	Port 1, SNP, SNP X (Breakless); Port 2, SNP, SNP X (Breakless), RTU Master and Slave (2 and 4 wire RTU Slave), SNP Master, Serial Read and Write	Port 1, SNP, SNP X (Breakless); Port 2, SNP, SNP X (Breakless), RTU Master and Slave (2 and 4 wire RTU Slave), SNP Master, Serial Read and Write
Power Voltage	12 VDC	120/240 VAC	12 VDC	12/24 VDC	24 VDC
Input Power Supply Rating	8 Watts	26 VA	8 Watts	8 Watts	8 Watts
24 VDC User Power for Sensors	200 mA	200 mA	200 mA	140 mA	200 mA
Input Device Voltage	12 VDC	24 VDC	12 VDC	24 VDC	24 VDC
Maximum Type A and B Counters	4 Type A and 1 Type B @ 10Khz (16 bit)	4 Type A and 1 Type B @ 10Khz (16 bit)	4 Type A and 1 Type B @ 10Khz (16 bit)	4 Type A and 1 Type B @ 10Khz (16 bit)	4 Type A and 1 Type B @ 10Khz (16 bit)
Output Control Voltage	12 VDC	Relay Out	Relay Out	Relay Out	Relay Out
Relay Maximum Resistive Load Rating	N/A	2 Amps at 24 VDC and 240 VAC	2 Amps at 24 VDC and 240 VAC	2 Amps at 24 VDC and 240 VAC	2 Amps at 24 VDC and 240 VAC
Maximum Number of PWM/Pulse Outputs	4 @ 5Khz (32 bit)	1 @ 5Khz (16 bit)	1 @ 5Khz (16 bit)	1 @ 5Khz (16 bit)	1 @ 5Khz (16 bit)
Dimensions (W x H x D) mm	150 x 90 x 76	150 x 90 x 76	150 x 90 x 76	150 x 90 x 76	150 x 90 x 76
Programming Software	VersaPro 1.1 or greater, Machine Edition Logic Developer	VersaPro 1.1 or greater, Machine Edition Logic Developer	VersaPro 1.1 or greater, Machine Edition Logic Developer	Machine Edition Logic Developer 5.0, Service Pack 3, Hotfix	VersaPro 1.1 or greater, Machine Edition Logic Developer
Portable Memory Module Support	No	No	No	No	No

Micro 20 PLC



The Micro 20 PLC is big on features, expandable to 132 I/O points to fast cycle times, robust instruction set, and generous memory to allow more flexible programming. The optional second port provides you with the option of an additional RS-232 port, RS-485, USB, or Ethernet. The serial expansion ports come with two analog input channels. A user-friendly memory module is available to easily download changes to the controller without the need of a PC. And it's all packaged in a sturdy modular design for easy access and long-term durability. This all-in-one PLC gives you everything you need to control a wide variety of applications.

	IC200UDD020	IC200UDD220	IC200UDR120	IC200UDR020
Product Name	Micro 20; (12) 24 VDC In, (8) 24 VDC Source Out 0.7 amps with ESCP protection, 24 VDC Powered	Micro 20; (12) 24 VDC In, (8) 24 VDC Sink Out, 24 VDC Powered	Micro 20; (12) 24 VDC In, (8) Relay Out 2.0 amps, 120/240VAC Powered	Micro 20; (12) 24 VDC In, (8) Relay Out 2.0 amps, 24VDC Powered
Lifecycle Status	Active	Active	Active	Active
Number of Discrete Inputs/Outputs	12 In / 8 Out (Supports 4 Expansion Units)	12 In / 8 Out (Supports 4 Expansion Units)	12 In / 8 Out (Supports 4 Expansion Units)	12 In / 8 Out (Supports 4 Expansion Units)
Number of Analog Inputs/Outputs	Supports up to 4 analog expansion units (16 analog in/ 8 analog out)	Supports up to 4 analog expansion units (16 analog in/ 8 analog out)	Supports up to 4 analog expansion units (16 analog in/ 8 analog out)	Supports up to 4 analog expansion units (16 analog in/ 8 analog out)
Physical I/O Maximum	132	132	132	132
User Program Logic Memory (Words)	24 K	24 K	24 K	24 K
Registers (Words)	32 K	32 K	32 K	32 K
Analog Pots for Data Adjustment	No	No	No	No
Serial Port Connector Type	RJ-45 (RS-232) port 1 and optional port 2 DB-15 (RS-485) or RJ-45 (RS-232) or USB or RJ-45 (Ethernet 10/100Mbit)	RJ-45 (RS-232) port 1 and optional port 2 DB-15 (RS-485) or RJ-45 (RS-232) or USB or RJ-45 (Ethernet 10/100Mbit)	RJ-45 (RS-232) port 1 and optional port 2 DB-15 (RS-485) or RJ-45 (RS-232) or USB or RJ-45 (Ethernet 10/100Mbit)	RJ-45 (RS-232) port 1 and optional port 2 DB-15 (RS-485) or RJ-45 (RS-232) or USB or RJ-45 (Ethernet 10/100Mbit)
Protocols	Both Ports: SNP, SNP X (Breakless), RTU Master and Slave 2 and 4 wire RTU Slave), SNP Master, Serial Read and Write; Ethernet SRTP, Modbus TCP (server) and Tunneling	Both Ports: SNP, SNP X (Breakless), RTU Master and Slave 2 and 4 wire RTU Slave), SNP Master, Serial Read and Write; Ethernet SRTP, Modbus TCP (server) and Tunneling	Both Ports: SNP, SNP X (Breakless), RTU Master and Slave 2 and 4 wire RTU Slave), SNP Master, Serial Read and Write; Ethernet SRTP, Modbus TCP (server) and Tunneling	Both Ports: SNP, SNP X (Breakless), RTU Master and Slave 2 and 4 wire RTU Slave), SNP Master, Serial Read and Write; Ethernet SRTP, Modbus TCP (server) and Tunneling
Power Voltage	24 VDC	24 VDC	120/240 VAC	24 VDC
Input Power Supply Rating	10 Watts	10 Watts	35 VA	10 Watts
24 VDC User Power for Sensors	435 mA	435 mA	435 mA	435 mA
Input Device Voltage	24 VDC	24 VDC	24 VDC	24 VDC
Maximum Type A and B Counters	4 Type A and 1 Type B @ 100Khz (32 bit)	4 Type A and 1 Type B @ 100Khz (32 bit)	4 Type A and 1 Type B @ 100Khz (32 bit)	4 Type A and 1 Type B @ 100Khz (32 bit)
Output Control Voltage	24 VDC ESCP; Self Healing; No External Fusing Required	24 VDC Sink	Relay Out	Relay Out
Relay Maximum Resistive Load Rating	N/A	N/A	2 Amps at 24 VDC and 240 VAC	2 Amps at 24 VDC and 240 VAC
Maximum Number of PWM/Pulse Outputs	4 @ 65Khz (32 bit)	4 @ 65Khz (32 bit)	N/A	N/A
Dimensions (W x H x D) mm	150 x 90 x 76	150 x 90 x 76	150 x 90 x 76	150 x 90 x 76
Programming Software	Machine Edition Logic Developer 5.0, Service Pack 3, Hotfix	Machine Edition Logic Developer 5.0, Service Pack 3, Hotfix	Machine Edition Logic Developer 5.0, Service Pack 3, Hotfix	Machine Edition Logic Developer 5.0, Service Pack 3, Hotfix
Portable Memory Module Support	Yes	Yes	Yes	Yes

Micro 40 PLC



The Micro 40 PLC is big on features, expandable to 152 I/O points to fast cycle times, robust instruction set, and generous memory to allow more flexible programming. The optional second port provides you with the option of an additional RS-232 port, RS-485, USB, or Ethernet. The serial expansion ports come with two analog input channels. A user-friendly memory module is available to easily download changes to the controller without the need of a PC. And it's all packaged in a sturdy modular design for easy access and long-term durability. This all-in-one PLC gives you everything you need to control a wide variety of applications.

	IC200UDD040	IC200UDD240	IC200UDR140	IC200UDR040	IC200UDR440
Product Name	Micro 40; (24) 24 VDC In, (16) 24 VDC Source Out, 0.7 amps with ESCP protection, 24 VDC Powered	Micro 40; (24) 24 VDC In, (16) 24 VDC Sink Out, 24 VDC Powered	Micro 40; (24) 24 VDC In, (16) Relay Out 2.0 amps, 120/240 VAC Powered	Micro 40; (24) 24 VDC In, (16) Relay Out 2.0 amps, 24 VDC Powered	Micro 40; (24) 24 VDC In, (16) Relay Out 2.0 amps 12/24 VDC Powered
Lifecycle Status	Active	Active	Active	Active	Active
Number of Discrete Inputs/Outputs	24 In / 16 Out (Supports 4 Expansion Units)	24 In / 16 Out (Supports 4 Expansion Units)	24 In / 16 Out (Supports 4 Expansion Units)	24 In / 16 Out (Supports 4 Expansion Units)	24 In / 16 Out (Supports 4 Expansion Units)
Number of Analog Inputs/Outputs	Supports up to 4 analog expansion units (16 analog in/ 8 analog out)	Supports up to 4 analog expansion units (16 analog in/ 8 analog out)	Supports up to 4 analog expansion units (16 analog in/ 8 analog out)	Supports up to 4 analog expansion units (16 analog in/ 8 analog out)	Supports up to 4 analog expansion units (16 analog in/ 8 analog out)
Physical I/O Maximum	152	152	152	152	152
User Program Logic Memory (Words)	24 K	24 K	24 K	24 K	24 K
Registers (Words)	32 K	32 K	32 K	32 K	32 K
Analog Pots for Data Adjustment	No	No	No	No	No
Serial Port Connector Type	RJ-45 (RS-232) port 1 and optional port 2 DB-15 (RS-485) or RJ-45 (RS-232) or USB or RJ-45 (Ethernet 10/100Mbit)	RJ-45 (RS-232) port 1 and optional port 2 DB-15 (RS-485) or RJ-45 (RS-232) or USB or RJ-45 (Ethernet 10/100Mbit)	RJ-45 (RS-232) port 1 and optional port 2 DB-15 (RS-485) or RJ-45 (RS-232) or USB or RJ-45 (Ethernet 10/100Mbit)	RJ-45 (RS-232) port 1 and optional port 2 DB-15 (RS-485) or RJ-45 (RS-232) or USB or RJ-45 (Ethernet 10/100Mbit)	RJ-45 (RS-232) port 1 and optional port 2 DB-15 (RS-485) or RJ-45 (RS-232) or USB or RJ-45 (Ethernet 10/100Mbit)
Protocols	Both Ports: SNP, SNP X (Breakless), RTU Master and Slave (2 and 4 wire RTU Slave), SNP Master, Serial Read and Write; Ethernet SRTTP, Modbus TCP (server) and Tunneling	Both Ports: SNP, SNP X (Breakless), RTU Master and Slave (2 and 4 wire RTU Slave), SNP Master, Serial Read and Write; Ethernet SRTTP, Modbus TCP (server) and Tunneling	Both Ports: SNP, SNP X (Breakless), RTU Master and Slave (2 and 4 wire RTU Slave), SNP Master, Serial Read and Write; Ethernet SRTTP, Modbus TCP (server) and Tunneling	Both Ports: SNP, SNP X (Breakless), RTU Master and Slave (2 and 4 wire RTU Slave), SNP Master, Serial Read and Write; Ethernet SRTTP, Modbus TCP (server) and Tunneling	Both Ports: SNP, SNP X (Breakless), RTU Master and Slave (2 and 4 wire RTU Slave), SNP Master, Serial Read and Write; Ethernet SRTTP, Modbus TCP (server) and Tunneling
Power Voltage	24 VDC	24 VDC	120/240 VAC	24 VDC	12/24 VDC
Input Power Supply Rating	10 Watts	10 Watts	35 VA	10 Watts	10 Watts
24 VDC User Power for Sensors	435 mA	435 mA	435 mA	435 mA	120 mA
Input Device Voltage	24 VDC	24 VDC	24 VDC	24 VDC	24 VDC
Maximum Type A and B Counters	4 Type A and 1 Type B @ 100Khz (32 bit)	4 Type A and 1 Type B @ 100Khz (32 bit)	4 Type A and 1 Type B @ 100Khz (32 bit)	4 Type A and 1 Type B @ 100Khz (32 bit)	4 Type A and 1 Type B @ 100Khz (32 bit)
Output Control Voltage	24 VDC ESCP; Self Healing; No External Fusing Required	24 VDC Sink	Relay Out	Relay Out	Relay Out
Relay Maximum Resistive Load Rating	N/A	N/A	2 Amps at 24 VDC and 240 VA	2 Amps at 24 VDC and 240 VA	2 Amps at 24 VDC and 240 VA
Maximum Number of PWM/Pulse Outputs	4 @ 65Khz (32 bit)	4 @ 65Khz (32 bit)	N/A	N/A	N/A
Dimensions (W x H x D) mm	150 x 90 x 76	150 x 90 x 76	150 x 90 x 76	150 x 90 x 76	150 x 90 x 76
Programming Software	Machine Edition Logic Developer 5.0, Service Pack 3, Hotfix	Machine Edition Logic Developer 5.0, Service Pack 3, Hotfix	Machine Edition Logic Developer 5.0, Service Pack 3, Hotfix	Machine Edition Logic Developer 5.0, Service Pack 3, Hotfix	Machine Edition Logic Developer 5.0, Service Pack 3, Hotfix
Portable Memory Module Support	Yes	Yes	Yes	Yes	Yes

Micro 64 PLC



The Micro 64 PLC is big on features, expandable to 176 I/O points to fast cycle times, robust instruction set, and generous memory to allow more flexible programming. The optional second port provides you with the option of an additional RS-232 port, RS-485, USB, or Ethernet. The serial expansion ports come with two analog input channels. A user-friendly memory module is available to easily download changes to the controller without the need of a PC. And it's all packaged in a sturdy modular design for easy access and long-term durability. This all-in-one PLC gives you everything you need to control a wide variety of applications.

	IC200UDD064	IC200UDD164	IC200UDR164	IC200UDR064
Product Name	Micro 64; (40) 24 VDC In, (24) 24 VDC Source Out 0.7 amps with ESCP protection, 24 VDC Powered.	Micro 64; (40) 24 VDC In, (24) 24 VDC Sink Out 0.7 amps, 24 VDC Powered.	Micro 64; (40) 24 VDC In, (24) Relay Out 2.0 amps, 120/240 VAC Powered.	Micro 64; (40) 24 VDC In, (24) Relay Out 2.0 amps, 24 VDC Powered.
Lifecycle Status	Active	Active	Active	Active
Number of Discrete Inputs/Outputs	40 In / 24 Out (Supports 4 Expansion Units)	40 In / 24 Out (Supports 4 Expansion Units)	40 In / 24 Out (Supports 4 Expansion Units)	40 In / 24 Out (Supports 4 Expansion Units)
Number of Analog Inputs/Outputs	Supports up to 4 analog expansion units (16 analog in/ 8 analog out)	Supports up to 4 analog expansion units (16 analog in/ 8 analog out)	Supports up to 4 analog expansion units (16 analog in/ 8 analog out)	Supports up to 4 analog expansion units (16 analog in/ 8 analog out)
Physical I/O Maximum	176	176	176	176
User Program Logic Memory (Words)	24K	24K	24 K	24 K
Registers (Words)	32 K	32 K	32 K	32 K
Analog Pots for Data Adjustment	No	No	No	No
Serial Port Connector Type	RJ-45 (RS-232) port 1 and optional port 2 DB-15 (RS-485) or RJ-45 (RS-232) or USB or RJ-45 (Ethernet 10/100 Mbit)	RJ-45 (RS-232) port 1 and optional port 2 DB-15 (RS-485) or RJ-45 (RS-232) or USB or RJ-45 (Ethernet 10/100 Mbit)	RJ-45 (RS-232) port 1 and optional port 2 DB-15 (RS-485) or RJ-45 (RS-232) or USB or RJ-45 (Ethernet 10/100 Mbit)	RJ-45 (RS-232) port 1 and optional port 2 DB-15 (RS-485) or RJ-45 (RS-232) or USB or RJ-45 (Ethernet 10/100 Mbit)
Protocols	Both Ports: SNP, SNP X (Breakless), RTU Master and Slave (2 and 4 wire RTU Slave), SNP Master, Serial Read and Write; Ethernet SRTP, Modbus TCP (server) and Tunneling	Both Ports: SNP, SNP X (Breakless), RTU Master and Slave (2 and 4 wire RTU Slave), SNP Master, Serial Read and Write; Ethernet SRTP, Modbus TCP (server) and Tunneling	Both Ports: SNP, SNP X (Breakless), RTU Master and Slave (2 and 4 wire RTU Slave), SNP Master, Serial Read and Write; Ethernet SRTP, Modbus TCP (server) and Tunneling	Both Ports: SNP, SNP X (Breakless), RTU Master and Slave (2 and 4 wire RTU Slave), SNP Master, Serial Read and Write; Ethernet SRTP, Modbus TCP (server) and Tunneling
Power Voltage	24 VDC	24 VDC	120/240 VAC	24 VDC
Input Power Supply Rating	10 Watts	10 Watts	35 VA	10 Watts
24 VDC User Power for Sensors	435 mA	435 mA	435 mA	435 mA
Input Device Voltage	24 VDC	24 VDC	24 VDC	24 VDC
Maximum Type A and B Counters	4 Type A and 1 Type B @ 100Khz (32 bit)	4 Type A and 1 Type B @ 100Khz (32 bit)	4 Type A and 1 Type B @ 100Khz (32 bit)	4 Type A and 1 Type B @ 100Khz (32 bit)
Output Control Voltage	24 VDC ESCP, Self Healing, No External Fusing Required	24 VDC Sink	Relay Out	Relay Out
Relay Maximum Resistive Load Rating	N/A	N/A	2 Amps at 24 VDC and 240 VAC	2 Amps at 24 VDC and 240 VAC
Maximum Number of PWM/Pulse Outputs	4 @ 65Khz (32 bit)	4 @ 65Khz (32 bit)	N/A	N/A
Dimensions (W x H x D) mm	190 x 90 x 76	190 x 90 x 76	190 x 90 x 76	190 x 90 x 76
Programming Software	Machine Edition Logic Developer 5.0, Service Pack 3, Hotfix	Machine Edition Logic Developer 5.0, Service Pack 3, Hotfix	Machine Edition Logic Developer 5.0, Service Pack 3, Hotfix	Machine Edition Logic Developer 5.0, Service Pack 3, Hotfix
Portable Memory Module Support	Yes	Yes	Yes	Yes

Discrete Expansion Selection Guide

Model	Module Input Power	12 VDC Inputs	12 VDC Outputs	24 VDC Inputs	120 VAC Input	24 VDC Outputs Source	24 VDC Outputs with ESCP	24 VDC Sink Outputs	120 VAC Output	Relay Outputs, 2 Amps	Relay Outputs, 5 Amps	Relay Outputs 10 Amps
IC200UEI08	24 VDC			8 Inputs								
IC200UEI016	24 VDC			16 Inputs								
IC200UEO008	24 VDC						8 Outputs					
IC200UEO016	24 VDC						16 Outputs					
IC200UEO108	24 VDC							8 Outputs				
IC200UEO116	24 VDC							16 Outputs				
IC200UER508	24 VDC										8 Outputs	
IC200UER008	24 VDC									8 Outputs		
IC200UER016	24 VDC									16 Outputs		
IC200UEC008	24 VDC			4 Inputs/ 4 Source Outputs			4 Inputs/ 4 Source Outputs					
IC200UEC108	24 VDC			4 Inputs/ 4 Sink Outputs				4 Inputs/ 4 Sink Outputs				
IC200UEC208	24 VDC			4 Inputs/ 4 Relay Outputs						4 Inputs/ 4 Relay Outputs		
IC200UEX015	12 VDC	8 Inputs/ 6 12 VDC Outputs	8 Inputs/ 6 12 VDC Outputs									
IC200UEX013	12 VDC	8 Inputs/ 6 Relay Outputs								8 Inputs/ 6 Relay Outputs		
IC200UEX014	24 VDC			8 Inputs/ 6 24 VDC Outputs		8 Inputs/ 6 24 VDC Outputs						
IC200UEX122	24 VDC			8 Inputs/ 6 24 VDC Outputs with ESCP			8 Inputs/ 6 24 VDC Outputs with ESCP					
IC200UEX012	24 VDC			8 Inputs/ 6 Relay Outputs						8 Inputs/ 6 Relay Outputs		
IC200UEX011	120/ 240 VAC			8 Inputs/ 6 Relay Outputs						8 Inputs/ 6 Relay Outputs		
IC200UEX009	120/ 240 VAC				8 Inputs/ 6 Relay Outputs (4 @ 2 amps and 2 @ 10 amps)					8 Inputs/ 6 Relay Outputs (4 @ 2 amps and 2 @ 10 amps)		8 Inputs/ 6 Relay Outputs (4 @ 2 amps and 2 @ 10 amps)
IC200UEX010	120/ 240 VAC				8 Inputs/ 6 AC Outputs				8 Inputs/ 6 AC Outputs			
IC200UEX215	12 VDC	16 Inputs/ 12 12 VDC Outputs	16 Inputs/ 12 12 VDC Outputs									
IC200UEX213	12 VDC	16 Inputs/ 12 Relay Outputs								8 Inputs/ 6 Relay Outputs		
IC200UEX214	24 VDC			16 Inputs/ 12 24 VDC Outputs		16 Inputs/ 12 24 VDC Outputs						
IC200UEX222	24 VDC			16 Inputs/ 12 24 VDC Outputs with ESCP			16 Inputs/ 12 24 VDC Outputs with ESCP					
IC200UEX212	24 VDC			16 Inputs/ 12 Relay Outputs						16 Inputs/ 12 Relay Outputs		
IC200UEX211	120/ 240 VAC			16 Inputs/ 12 Relay Outputs						16 Inputs/ 12 Relay Outputs		
IC200UEX209	120/ 240 VAC				16 Inputs/ 12 Relay Outputs (10 @ 2 amps and 2 @ 10 amps)					16 Inputs/ 12 Relay Outputs (10 @ 2 amps and 2 @ 10 amps)		16 Inputs/ 12 Relay Outputs (10 @ 2 amps and 2 @ 10 amps)
IC200UEX210	120/ 240 VAC				16 Inputs/ 12 AC Outputs				16 Inputs/ 12 AC Outputs			
IC200UEX264*	24 VDC			40 Inputs/ 24 24 VDC Outputs			40 Inputs/ 24 24 VDC Outputs					
IC200UEX364*	24 VDC			40 Inputs/ 24 24 VDC Outputs		40 Inputs/ 24 24 VDC Outputs						
IC200UEX064*	24 VDC			40 Inputs/ 24 Relay Outputs						40 Inputs/ 24 Relay Outputs		
IC200UEX164*	120/ 240 VAC			40 Inputs/ 24 Relay Outputs						40 Inputs/ 24 Relay Outputs		

*Micro 20, 40 and 64 support only.

Discrete Expansion Units



The VersaMax Micro's modular design provides you with remarkable flexibility in a compact control. The versatile Micro PLC can support up to four Expansion Units of any mix of discrete or analog.

	IC200UEI008	IC200UEI016	IC200UEO008	IC200UEO016	IC200UEO108	IC200UEO116
Product Name	8 point (8) 24 VDC In, 24 VDC Powered	16 point (16) 24 VDC In, 24 VDC Powered	8 point (8) 24 VDC Output with ESCP Protection, 24 VDC Powered	16 point (16) 24 VDC Output with ESCP Protection, 24 VDC Powered	8 point (8) 24 VDC Sink Output, 24 VDC Powered	16 point (16) 24 VDC Sink Output, 24 VDC Powered
Lifecycle Status	Active	Active	Active	Active	Active	Active
Micro Type Restrictions	N/A	N/A	N/A	N/A	N/A	N/A
Number of Discrete Inputs/Outputs	8 In	16 In	8 Out	16 Out	8 Out	16 Out
Power Voltage	24 VDC	24 VDC	24 VDC	24 VDC	24 VDC	24 VDC
Input Power Supply Rating	4 Watts	4 Watts	4 Watts	4 Watts	4 Watts	4 Watts
24 VDC User Power for Sensors	200 mA	200 mA	200 mA	200 mA	200 mA	200 mA
Input Device Voltage	24 VDC	24 VDC	N/A	N/A	N/A	N/A
Output Control Voltage	N/A	N/A	24 VDC ESCP, Self Healing, No External Fusing Required	24 VDC ESCP, Self Healing, No External Fusing Required	24 VDC Sink	24 VDC Sink
Relay Maximum Resistive Load Rating	N/A	N/A	N/A	N/A	N/A	N/A
Dimensions (W x H x D) mm	95 x 90 x 76	95 x 90 x 76	95 x 90 x 76	95 x 90 x 76	95 x 90 x 76	95 x 90 x 76

Discrete Expansion Units



The VersaMax Micro's modular design provides you with remarkable flexibility in a compact control. The versatile Micro PLC can support up to four Expansion Units of any mix of discrete or analog.

	IC200UER508	IC200UER008	IC200UER016	IC200UEC008	IC200UEC108	IC200UEC208
Product Name	8 point (8) 5 Amp Relay Out, 24 VDC Power Supply (not UL approved)	8 point (8) 2 Amp Relay Out, 24 VDC Power Supply	16 point (16) Relay Out, 24 VDC Power Supply	8 point (4) 24 VDC In, (4) 24 VDC Out with ESCP Protection, 24 VDC Power Supply	8 point (4) 24 VDC In, (4) 24 VDC Sink Out, 24 VDC Power Supply	8 point (4) 24 VDC In, (4) Relay Out, 24 VDC Power Supply
Lifecycle Status	Active	Active	Active	Active	Active	Active
Micro Type Restrictions	None	None	None	None	None	None
Number of Discrete Inputs/Outputs	8 Out	8 Out	16 Out	4 In / 4 Out	4 In / 4 Out	4 In / 4 Out
Power Voltage	24 VDC	24 VDC	24 VDC	24 VDC	24 VDC	24 VDC
Input Power Supply Rating	4 Watts	4 Watts	4 Watts	4 Watts	4 Watts	4 Watts
24 VDC User Power for Sensors	200 mA	200 mA	200 mA	200 mA	200 mA	200 mA
Input Device Voltage	N/A	N/A	N/A	24 VDC	24 VDC	24 VDC
Output Control Voltage	Relay Out	Relay Out	Relay Out	24 VDC ESCP, Self Healing, No External Fusing Required	24 VDC Sink	Relay Out
Relay Maximum Resistive Load Rating	5 Amps at 24 VDC and 240 VAC	2 Amps at 24 VDC and 240 VAC	2 Amps at 24 VDC and 240 VAC	N/A	N/A	2 Amps at 24 VDC and 240 VAC
Dimensions (W x H x D) mm	95 x 90 x 76	95 x 90 x 76	95 x 90 x 76	95 x 90 x 76	95 x 90 x 76	95 x 90 x 76

Discrete Expansion Units



The VersaMax Micro's modular design provides you with remarkable flexibility in a compact control. The versatile Micro PLC can support up to four Expansion Units of any mix of discrete or analog.

	IC200UEX015	IC200UEX013	IC200UEX014	IC200UEX122	IC200UEX012	IC200UEX011
Product Name	14 point (8) 12 VDC In, (6) 12 VDC Out, 12 VDC Powered	14 point (8) 12 VDC In, (6) Relay Out, 12 VDC Powered	14 point (8) 24 VDC In, (6) 24 VDC Out, 24 VDC Powered	14 point (8) 24 VDC In, (6) 24 VDC Out with ESCP, 24 VDC Powered	14 point (8) 24 VDC In, (6) Relay Out, 24 VDC Powered	14 point (8) 24 VDC In, (6) Relay Out, 120/240 VAC Powered
Lifecycle Status	Active	Active	Active	Active	Active	Active
Micro Type Restrictions	N/A	N/A	N/A	N/A	N/A	N/A
Number of Discrete Inputs/Outputs	8 In / 6 Out	8 In / 6 Out	8 In / 6 Out	8 In / 6 Out	8 In / 6 Out	8 In / 6 Out
Power Voltage	12 VDC	12 VDC	24 VDC	24 VDC	24 VDC	120/240 VAC
Input Power Supply Rating	4 Watts	4 Watts	4 Watts	4 Watts	4 Watts	13 VA
24 VDC User Power for Sensors	200 mA	200 mA	200 mA	200 mA	200 mA	200 mA
Input Device Voltage	12 VDC	12 VDC	24 VDC	24 VDC	24 VDC	24 VDC
Output Control Voltage	12 VDC	Relay Out	24 VDC	24 VDC ESCP, Self Healing, No External Fusing Required	Relay Out	Relay Out
Relay Maximum Resistive Load Rating	N/A	2 Amps at 24 VDC and 240 VAC	N/A	N/A	2 Amps at 24 VDC and 240 VAC	2 Amps at 24 VDC and 240 VAC
Dimensions (W x H x D) mm	95 x 90 x 76	95 x 90 x 76	95 x 90 x 76	95 x 90 x 76	95 x 90 x 76	95 x 90 x 76

Discrete Expansion Units



The VersaMax Micro's modular design provides you with remarkable flexibility in a compact control. The versatile Micro PLC can support up to four Expansion Units of any mix of discrete or analog.

	IC200UEX009	IC200UEX010	IC200UEX215	IC200UEX213	IC200UEX214
Product Name	14 point (8) 120 VAC In, (6) Relay Out (2 outputs at 10 amp and 4 outputs at 2 amp), 120/240 VAC Powered	14 point (8) 120 VAC In, (6) 120 VAC Out, 120/240 VAC Powered	28 point (16) 12 VDC In, (12) 12 VDC Out, 12 VDC Powered	28 point (16) 12 VDC In, (12) Relay Out, 12 VDC Powered	28 point (16) 24 VDC In, (12) 24 VDC Out, 24 VDC Powered
Lifecycle Status	Active	Active	Active	Active	Active
Micro Type Restrictions	N/A	N/A	N/A	N/A	N/A
Number of Discrete Inputs/Outputs	8 In / 6 Out	8 In / 6 Out	16 In / 12 Out	16 In / 12 Out	16 In / 12 Out
Power Voltage	120/240 VAC	120/240 VAC	12 VDC	12 VDC	24 VDC
Input Power Supply Rating	11 VA	11 VA	8 Watts	8 Watts	5 Watts
24 VDC User Power for Sensors	200 mA	200 mA	200 mA	200 mA	200 mA
Input Device Voltage	120 VAC	120 VAC	12 VDC	12 VDC	24 VDC
Output Control Voltage	Relay Out (2 at 10 Amps and 4 at 2 Amps)	120 VAC	12 VDC	Relay Out	24 VDC
Relay Maximum Resistive Load Rating	2 Amps at 24 VDC and 240 VAC; 10 Amp at 24 VDC and 240 VAC	N/A	N/A	2 Amps at 24 VDC and 240 VAC	N/A
Dimensions (W x H x D) mm	95 x 90 x 76	95 x 90 x 76	150 x 90 x 76	150 x 90 x 76	150 x 90 x 76

Discrete Expansion Units



The VersaMax Micro's modular design provides you with remarkable flexibility in a compact control. The versatile Micro PLC can support up to four Expansion Units of any mix of discrete or analog.

	IC200UEX222	IC200UEX212	IC200UEX211	IC200UEX209	IC200UEX210
Product Name	28 point (16) 24 VDC In, (12) 24 VDC Out with ESCP, 24 VDC Powered	28 point (16) 24 VDC In, (12) Relay Out, 24 VDC Powered	28 point (16) 24 VDC In, (12) Relay Out, 120/240 VAC Powered	28 point (16) 120 VAC In, (12) Relay Out (2 outputs at 10 amp and 10 outputs at 2 amp), 120/240 VAC Powered	28 point (16) 24 VDC In, (12) 120 VAC Out, 120/240 VAC Powered
Lifecycle Status	Active	Active	Active	Active	Active
Micro Type Restrictions	N/A	N/A	N/A	N/A	N/A
Number of Discrete Inputs/Outputs	16 In / 12 Out	16 In / 12 Out	16 In / 12 Out	16 In / 12 Out	16 In / 12 Out
Power Voltage	24 VDC	24 VDC	120/240 VAC	120/240 VAC	120/240 VAC
Input Power Supply Rating	5 Watts	8 Watts	26 VA	16 VA	16 VA
24 VDC User Power for Sensors	200 mA	200 mA	200 mA	200 mA	200 mA
Input Device Voltage	24 VDC	24 VDC	24 VDC	120 VAC	120 VAC
Output Control Voltage	24 VDC ESCP, Self Healing, No External Fusing Required	Relay Out	Relay Out	Relay Out (2 at 10 Amps and 10 at 2 Amps)	120 VAC
Relay Maximum Resistive Load Rating	N/A	2 Amps at 24 VDC and 240 VAC	2 Amps at 24 VDC and 240 VAC	2 Amps at 24 VDC and 240 VAC; 10 Amps at 24 VDC and 240 VAC	N/A
Dimensions (W x H x D) mm	150 x 90 x 76	150 x 90 x 76	150 x 90 x 76	150 x 90 x 76	150 x 90 x 76

Discrete Expansion Units



The VersaMax Micro's modular design provides you with remarkable flexibility in a compact control. The versatile Micro PLC can support up to four Expansion Units of any mix of discrete or analog.

	IC200UEX064	IC200UEX164	IC200UEX264	IC200UEX364
Product Name	64 point (40) 24 VDC In, (24) Relay Out, 24 VDC Powered	64 point (40) 24 VDC In, (24) Relay Out, 120/240 VAC Powered	64 point (40) 24 VDC In, (24) 24 VDC Source Out, 24 VDC Powered	64 point (40) 24 VDC In, (24) 24 VDC Sink Out, 24 VDC Powered
Lifecycle Status	Active	Active	Active	Active
Micro Type Restrictions	Micro 20, 40, 64 Support Only	Micro 20, 40, 64 Support Only	Micro 20, 40, 64 Support Only	Micro 20, 40, 64 Support Only
Number of Discrete Inputs/Outputs	40 In / 24 Out	40 In / 24 Out	40 In / 24 Out	40 In / 24 Out
Power Voltage	24 VDC	120/240 VAC	24 VDC	24 VDC
Input Power Supply Rating	10 Watts	35 VA	10 Watts	10 Watts
24 VDC User Power for Sensors	435 mA	435 mA	435 mA	435 mA
Input Device Voltage	24 VDC	24 VDC	24 VDC	24 VDC
Output Control Voltage	Relay Out	Relay Out	24 VDC Sourced	24 VDC Sink
Relay Maximum Resistive Load Rating	2 Amps at 24 VDC and 240 VAC	2 Amps at 24 VDC and 240 VAC	N/A	N/A
Dimensions (W x H x D) mm	190 x 90 x 76	190 x 90 x 76	190 x 90 x 76	190 x 90 x 76

Analog Expansion Selection Guide

Model	Module Input Power	Input Range 0 to 10V -10V to +10V 0 to 20 mA 4 to 20 mA	Input Range RTD Pt 100	Input Range RTD Pt 100 Input Range Thermocouple Type K, J, E, S, T, B, N	Input Range millivolt ±50mV ±100mV	Output Range 0-10 VDC 0-20 mA
IC200UEX616	12 VDC	4 in / 2 out				4 in / 2 out
IC200UEX624	24 VDC	4 in				
IC200UEX626	24 VDC	4 in / 2 out				4 in / 2 out
IC200UEX636	120/240 VAC	4 in / 2 out				4 in / 2 out
IC200UEX724	24 VDC		4 in			
IC200UEX726	24 VDC		4 in / 2 out			4 in / 2 out
IC200UEX734	120/240 VAC		4 in			
IC200UEX736	120/240 VAC		4 in / 2 out			4 in / 2 out
IC200UEX824	24 VDC			4 in	4 in	
IC200UEX826	24 VDC			4 in / 2 out	4 in / 2 out	4 in / 2 out

Analog Expansion Units

The VersaMax Micro analog I/O is versatile and the Micro PLC can support up to four Analog Expansion Units, allowing you to expand up to 16 inputs and 8 outputs.



	IC200UEX624	IC200UEX616	IC200UEX626	IC200UEX636
Product Name	4 Analog I/O Channels 0 to 10 VDC, 4 to 20 mA, 24 VDC Powered	6 Analog I/O Channels (4) 0 to 10 VDC, ±10 VDC, 4 to 20 mA, 0 to 20 mA In, (2) 0 to 10 VDC, 4 to 20 mA, 0 to 20 mA Out, 12 VDC Powered	6 Analog I/O Channels (4) 0 to 10 VDC, ±10 VDC, 4 to 20 mA, 0 to 20 mA In, (2) 0 to 10 VDC, 4 to 20 mA, 0 to 20 mA Out, 24 VDC Powered	6 Analog I/O Channels (4) 0 to 10 VDC, ±10 VDC, 4 to 20 mA, 0 to 20 mA In, (2) 0 to 10 VDC, 4 to 20 mA, 0 to 20 mA Out, 120/240 VAC Powered
Lifecycle Status	Active	Active	Active	Active
Micro Type Restrictions	N/A	N/A	N/A	N/A
Number of Analog Inputs/Outputs	4 Channels In, Voltage or Current	4 Channels In / 2 Channels Out, Voltage or Current	4 Channels In / 2 Channels Out, Voltage or Current	4 Channels In / 2 Channels Out, Voltage or Current
Power Voltage	24 VDC	12 VDC	24 VDC	120/240 VAC
Input Power Supply Rating	3 Watts	2.25 Watts	3 Watts	15 VA
24 VDC User Power for Sensors	200 mA	200 mA	200 mA	200 mA
Analog Input Ranges	0-10V (10.23V Max); 0-±10V (±10.23V Max); 0-20 mA (20.47 mA Max); 4-20 mA; 12 bit resolution.	0-10V (10.23V Max); 0-±10V (±10.23V Max); 0-20 mA (20.47 mA Max); 4-20 mA; 12 bit resolution.	0-10V (10.23V Max); 0-±10V (±10.23V Max); 0-20 mA (20.47 mA Max); 4-20 mA; 12 bit resolution.	0-10V (10.23V Max); 0-±10V (±10.23V Max); 0-20 mA (20.47 mA Max); 4-20 mA; 12 bit resolution.
Analog Output Ranges	N/A	0 to 10 VDC (10.24V max.) 0 to 20 mA (20.5 mA max.) 4 to 20 mA (20.5 mA max.); 12 bit resolution.	0 to 10 VDC (10.24V max.) 0 to 20 mA (20.5 mA max.) 4 to 20 mA (20.5 mA max.); 12 bit resolution.	0 to 10 VDC (10.24V max.) 0 to 20 mA (20.5 mA max.) 4 to 20 mA (20.5 mA max.); 12 bit resolution.
Dimensions (W x H x D) mm	95 x 90 x 76	95 x 90 x 76	95 x 90 x 76	95 x 90 x 76

Analog Expansion Units

The VersaMax Micro analog I/O is versatile and the Micro PLC can support up to four Analog Expansion Units, allowing you to expand up to 16 inputs and 8 outputs.



	IC200UEX724	IC200UEX734	IC200UEX726	IC200UEX736
Product Name	4 RTD PT 100 Channels IN, 120/240 VAC Powered	4 RTD PT 100 Channels IN, 24 VDC Powered	4 RTD PT 100 Channels IN, 2 Analog Channels OUT 0 to 10 VDC, 4 to 20 mA, 0 to 20 mA Out, 24 VDC Powered	4 RTD PT 100 Channels IN, 2 Analog Channels OUT 0 to 10 VDC, 4 to 20 mA, 0 to 20 mA Out, 120/240 VAC Powered
Lifecycle Status	Active	Active	Active	Active
Micro Type Restrictions	16 bit supported on Micro 20, 40, 64 only	16 bit supported on Micro 20, 40, 64 only	16 bit supported on Micro 20, 40, 64 only	16 bit supported on Micro 20, 40, 64 only
Number of Analog Inputs/Outputs	4 Channels RTD In	4 Channels RTD In	4 Channels RTD In / 2 Channels Out, Voltage or Current	4 Channels RTD In / 2 Channels Out, Voltage or Current
Power Voltage	24 VDC	120/240 VAC	24 VDC	120/240 VAC
Input Power Supply Rating	3 Watts	15 VA	3 Watts	15 VA
24 VDC User Power for Sensors	200 mA	200 mA	200 mA	200 mA
Analog Input Ranges	2- and 3-wire types, PT 100; 16 bit	2- and 3-wire types, PT 100; 16 bit	2- and 3-wire types, PT 100; 16 bit	2- and 3-wire types, PT 100; 16 bit
Analog Output Ranges	N/A	N/A	0 to 10 VDC (10.24V max.) 0 to 20 mA (20.5 mA max.); 4 to 20 mA (20.5 mA max.); 12 bit resolution.	0 to 10 VDC (10.24V max.) 0 to 20 mA (20.5 mA max.); 4 to 20 mA (20.5 mA max.); 12 bit resolution.
Dimensions (W x H x D) mm	95 x 90 x 76	95 x 90 x 76	95 x 90 x 76	95 x 90 x 76

Analog Expansion Units

The VersaMax Micro analog I/O is versatile and the Micro PLC can support up to four Analog Expansion Units, allowing you to expand up to 16 inputs and 8 outputs.



	IC200UEX824	IC200UEX826
Product Name	4 Thermocouple or mV Input Channels, 24 VDC Powered	4 Thermocouple or mV Input Channels and 2 Analog Output Channels, 24 VDC Powered
Lifecycle Status	Active	Active
Micro Type Restrictions	16 bit supported on Micro 20, 40, 64 only	16 bit supported on Micro 20, 40, 64 only
Number of Analog Inputs/Outputs	4 Channels Thermocouple In or $\pm 50\text{mV}$ or $\pm 100\text{mV}$, 24 VDC Power Supply	4 Channels Thermocouple In or $\pm 50\text{mV}$ or $\pm 100\text{mV}$ and 2 channel analog outputs, 24 VDC Power Supply
Power Voltage	24 VDC	24 VDC
Input Power Supply Rating	3 Watts	3 Watts
24 VDC User Power for Sensors	200 mA	200 mA
Analog Input Ranges	Type K, J, E, S, T, B, N, $\pm 50\text{mV}$, $\pm 100\text{mV}$; 12 bit (16 bit 4th QTR 2009)	Type K, J, E, S, T, B, N, $\pm 50\text{mV}$, $\pm 100\text{mV}$; 12 bit (16 bit 4th QTR 2009)
Analog Output Ranges	N/A	0 to 10 VDC (10.24 V max.) 0 to 20 mA (20.5 mA max.) 4 to 20 mA (20.5 mA max.); 12 bit resolution.
Dimensions (W x H x D) mm	95 x 90 x 76	95 x 90 x 76



DataPanels Operator Interfaces

GE VersaMax DataPanels are ideal for a broad range of applications ranging from simple timer/counter/register access to full text message display with numeric keypad. All VersaMax DataPanels are preprogrammed to connect quickly to a VersaMax Micro or Nano PLC without user configuration.

	IC200DTX200	IC200DTX450	IC200DTX650	IC200DTX850
Product Name	Operator Interface for changing timer/counter/register values. 2x16 character LCD backlight display and 6 operation keys. No stored messaging, PLC stores messages. Requires IC200CBL550 cable or equivalent. Operates on 5 VDC @ 100 mA from Micro or Nano.	Operator Interface with up to 200 stored messages. 2x16 character LCD backlight display and 6 function keys. Requires IC200CBL555 or equivalent. Operates on external 24 VDC @ 40 mA.	Operator Interface with up to 200 stored messages. 4x16 character LCD backlight display and 8 function keys. Requires IC200CBL555 cable or equivalent. Operates on external 24 VDC @ 80 mA.	Operator Interface with up to 200 stored messages. 4x20 character LCD backlight display, 8 function keys and numeric keypad. Requires IC200CBL555 cable or equivalent. Operates on external 24 VDC @ 50 mA.
Lifecycle Status	Active	Active	Active	Active
Characters Per Line	16	16	16	20
Function Keys	0	6	8	8
Numeric Keypad	0	0	0	Yes
Memory Size (Number of Messages)	Messages stored in PLC	200 stored in operator interface	200 stored in operator interface	200 stored in operator interface
DataPanel Dimensions (W x H x D) mm	108 x 60 x 27	108 x 60 x 45	96 x 96 x 44	182 x 101 x 37
Number of Lines	2	2	4	4
Display Type	LCD Display with Backlight	LCD Display with Backlight	LCD Display with Backlight	LCD Display with Backlight
Operating Temperature	0°C to +50°C	0°C to +50°C	0°C to +50°C	0°C to +50°C
NEMA Rating	NEMA 4	NEMA 4	NEMA 4	NEMA 4
Programming Software	None required	DataDesigner (IC752DDZ000)	DataDesigner (IC752DDZ000)	DataDesigner (IC752DDZ000)

Micro 20, Micro 40 and Micro 64 Port 2 Communication Options

The VersaMax Micro 20, Micro 40 and Micro 64 Port 2 is modular by design and enables the user to select a wide range of communications options. The user can select RS-232, RS-485, Ethernet or USB. The RS-232 and RS-485 also come with two analog input channels (0 to 10 VDC, 10 bit). Port 2 also supports Memory Module Board that enables the user to download logic and settings without a PC.

	IC200UEM001	IC200USB001	IC200USB002	IC200UUB001
Product Name	Ethernet module	RS-232 option board with (2) 0 -10 VDC analog in	RS-485 option board with (2) 0 -10 VDC analog in	USB option board (no analog option)
Lifecycle Status	Active	Active	Active	Active
Micro Type Restrictions	Micro 20, 40, 64 Support Only	Micro 20, 40, 64 Support Only	Micro 20, 40, 64 Support Only	Micro 20, 40, 64 Support Only
Connection Type	10/100Mbps port supporting RJ45 connection	RS-232 (RJ-45)	RS-485 (RJ-45)	USB (Slave Only) version 2.0, Straight B type
Protocol Supported	SRTP and Modbus TCP (server)	SNP, SNP Master, SNP X, Modbus Master, Modbus Slave, Serial Read and Write	SNP, SNP Master, SNP X, Modbus Master, Modbus Slave, Serial Read and Write	SNP, SNP X, Modbus Slave, Serial Read
Analog Support on Communications Module	No Analog Support	Two Analog Inputs. 0 to 10 VDC (10 bits)	Two Analog Inputs. 0 to 10 VDC (10 bits)	No Analog Support
Memory Module Board Support	Yes	Yes	Yes	Yes
Programming Support	Yes, SRTP only	Yes	Yes	Yes
Programming Software	Machine Edition Logic Developer 5.0, Service Pack 3, Hotfix	Machine Edition Logic Developer 5.0, Service Pack 3, Hotfix	Machine Edition Logic Developer 5.0, Service Pack 3, Hotfix	Machine Edition Logic Developer 5.0, Service Pack 3, Hotfix



Ethernet Communication Option

The VersaMax SE enables the VersaMax Micro and Nano to easily be connected to an Ethernet LAN via the VersaMax SE. The user can easily download, upload and monitor VersaMax Micro and Nano controllers.

IC200SET001

Product Name	Ethernet to Serial Network Module
Lifecycle Status	Active
Ethernet Port	10/100Mbps port supporting RJ45 connection
Serial Port	One RS-232 and one RS-485 port (up to 16 devices supported)
Communications Configurations	Communication configurations include Ethernet SRTP to SNP or Modbus TCP to Modbus Slave
Power Voltage	12/24 VDC
Dimensions (W x H x D) mm	36 x 90 x 60
Programming Software	VersaPro 2.0 or greater, Machine Edition Logic Developer
Mounting	35 mm DIN-rail or Panel Mount
Power Supply Voltage Range	12/24 VDC

Portable Program Download Device (PPDD)

The Portable Program Download Device enables the user to easily upload and download VersaMax Micro 23/28 configuration and logic from/to a USB Memory Stick. Portable Program Download Device (PPDD) will support commercial memory stick devices using USB connection. The purpose of the PPDD is to allow users to store and download their logic applications and configuration to GE VersaMax Micro 23/28 PLCs without the need of a PC. The PPDD plugs into the 15 pin RS-485 port on the VersaMax Micro 23/28 CPU base power supply. The RS-485 port provides the power for the PPDD. VersaMax Micro 23/28 logic and configuration files can be zipped and easily emailed to remote locations for VersaMax Micro 23/28 downloads.



There are many advantages of the PPDD such as:

- No PC required to backup applications or download applications
- No expensive travel to perform field upgrades, just email the file to the remote location
- Compatible with commercial off the shelf USB Memory Sticks
- The PPDD can be panel mounted, DIN-rail mounted or hand held
- Supports diagnostics to ensure that the CPU is compatible with the application
- OEM Password Protection supported
- Simple to operate, LEDs to show activity, error and status. Push button to start download and selector switch for direction of download, to the PLC or to the memory stick.
- Designed for the industrial environment UL and CE (not Class 1 Div 2 approved)

PPDD features:

- Slide switch for direction of data storage
- Status and Diagnostic LEDs

LEDs Status

	Error (Red)	Status (Green)
LED On Steady	On when there isn't a Memory Stick attached	On after button has been pushed and name in PLC matches and when download is complete
LED Flashing	Flashing when CPU doesn't match or Memory Stick doesn't have the proper file\	Slow Flash During Download
Fast Flash (500msec on 500msec off)	Flashing if Verify fails	Fast Flash when CPU type matches but name in PLC doesn't match
Slow Flash (1 sec on 1 sec off)		
LED Off	Off during normal conditions with no errors	Off prior to button being pushed for download

The Portable Program Download Device is simple to use. The example below demonstrates the four easy steps of downloading an application and emailing it to a remote location for application upgrade.

Step 1.
 Slide PPDD selector toward USB memory stick.
 Press PPDD download button. The PPDD will store/verify the VersaMax Micro application and configuration onto the USB memory stick.

Step 4.
 Place the USB memory stick in the PPDD, slide selector toward controller.
 Press PPDD download button. The PPDD will stop the CPU and download/verify file. The CPU can be placed in the Run mode via the key switch or cycling power.

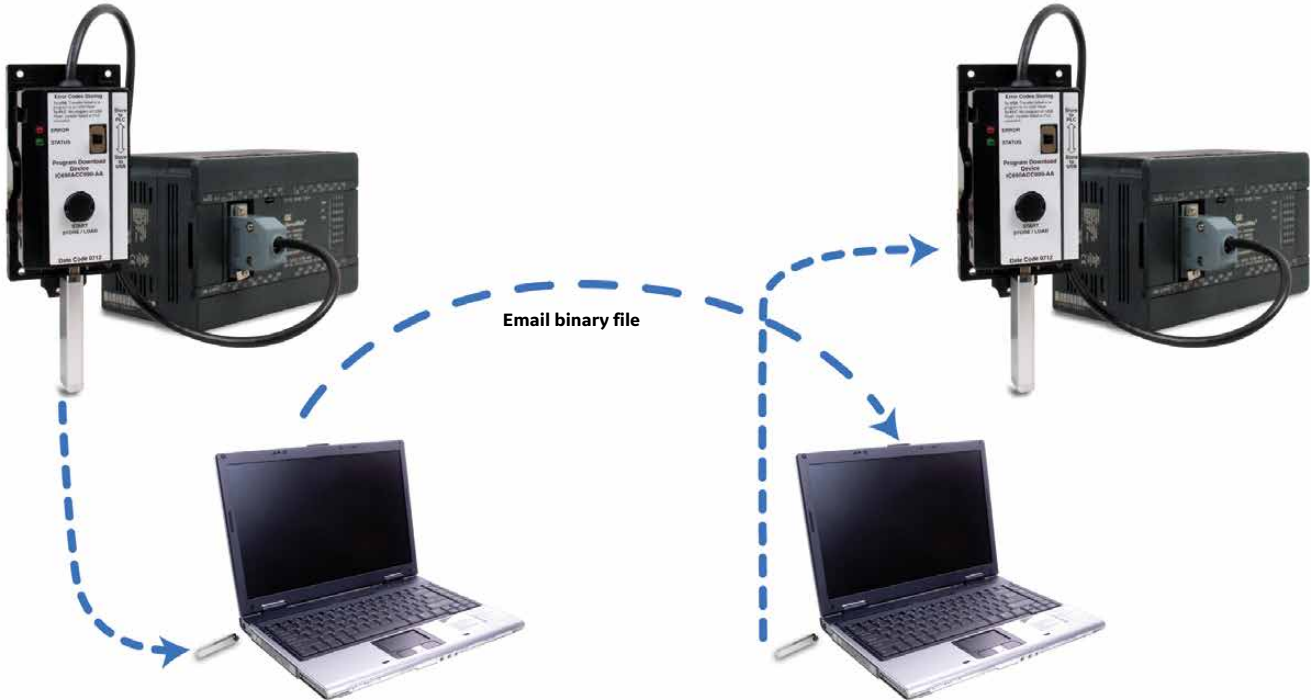

Step 2.
 Remove the memory stick from the PPDD and connect it to your PC. Copy the binary file from the memory stick to your PC and email to remote location.

Step 3.
 Remote location takes the binary file that is in the email and stores it on a USB memory stick.

Portable Program Download Device

Part Number	Description
IC690ACC990	Portable Program Download Device. Supports standard USB memory devices to store and load VersaMax Micro 23/28 PLC applications without the need of a PC.

Accessories

Part Number	Description	Lifecycle Status
IC200ACC402	Spare Removable Terminal Strips, 10 per pack. (Micro 14, Micro 23 and Micro 28 and all expansion units)	Active
IC200ACC403	Battery for Micro 23 and Micro 28 for data retention (5.2 months minimum @ 70°C and 32.4 months minimum @ 20°C)	Active
IC200ACC404	Spare parts kit. Two terminal strips and four plastic doors and four covers for Micro 14, Micro 23 and Micro 28.	Active
IC200ACC414	Long Term Battery for Micro 23, Micro 28 and Micro 64 (19 months minimum @ 70°C and 121 months minimum @ 20°C)	Active
IC200ACC415	RS-232 to RS-485 Converter requires IC200CBL500 or equivalent.	Active
IC200ACC451	Simulator for VersaMax Micro 14, Micro 23 and Micro 28. (8 Inputs)	Active
IC200UMB001	Flash Memory Board for program download and compatible with Micro 64 (128Kbytes)	Active

External Power Supplies

Part Number	Description	Lifecycle Status
IC690PWR024	24 VDC, 5 Amp Output Power and 120/230 VAC Input Power Power Supply	Active
IC690PWR124	24 VDC, 10 Amp Output Power and 120/230 VAC Input Power Power Supply	Active

Programming and Trouble Shooting Tools

Part Number	Description	Lifecycle Status
IC646MPM101	Proficy Logic Developer - PLC Nano/Micro, Programming Cable (No Upgrades included)	Active
IC752DDZ000	VersaMax DP Operator Interface DataDesigner editor	Active

Cables

(0.1 meter cable, IC200CBL501, is included in every expansion base package)

Part Number	Description	Lifecycle Status
IC200CBL500	Programming cable (RJ-45 to DB-9 pin) RS-232. 3 Meters.	Active
IC200CBL501	I/O Expansion cable, 0.1 meter long (Qty 5)	Active
IC200CBL505	I/O Expansion cable, 0.5 meter long	Active
IC200CBL510	I/O Expansion cable, 1 meter long	Active

Starter Kits

Part Number	Description	Lifecycle Status
IC200TBX010	Tool box, Nano 10 and software. Includes (IC200NDR001) 24 VDC In/Relay Out, 24 VDC powered (requires an external 24 VDC Supply) with software, manuals and cables (IC646MPH101)	Active
IC200TBX110	Tool box, Nano 10, operator interface and software. Includes (IC200NDR001) 24 VDC In/Relay Out, 24 VDC powered (requires an external 24 VDC Supply), VersaMax DataPanel DP45 with programming software and cables, (IC640VPS00, IC752DDZ000, IC200CBL555)	Active
IC200TBX210	Tool box, Nano 10, Ethernet interface and software. Includes (IC200NDR001) 24 VDC In/Relay Out, 24 VDC powered (requires an external 24 VDC Supply), VersaMax SE (IC200SET001) with all software, cables (IC646MPH101) and manuals.	Active
IC200TBX014	Tool box, Micro 14 and software. Includes (IC200UDR001) 24 VDC In/Relay Out, AC Power Supply with software, manuals and cables (IC646MPH101)	Active
IC200TBX114	Tool box, Micro 14, operator interface and software. Includes (IC200UDR001) 24 VDC In/Relay Out, AC Power Supply, VersaMax DataPanel DP45 with programming software and cables, (IC640VPS00, IC752DDZ000, IC200CBL555)	Active
IC200TBX214	Tool box, Micro 14, Ethernet interface and software. Includes (IC200UDR001) 24 VDC In/Relay Out, requires 120 VAC power, VersaMax SE (IC200SET001) with all software, cables (IC646MPH101) and manuals.	Active
IC200TBX023	Tool box, Micro 23 and software. Includes (IC200UAL006) DC In/Relay Out, 2 analog In, 1 analog out, AC Power Supply with software, manuals and cables (IC646MPH101)	Active
IC200TBX123	Tool box, Micro 23, operator interface and software. Includes (IC200UAL006) 24 VDC In/Relay Out, 2 Analog In/1 Analog out, AC P/S, VersaMax DataPanel DP45 with programming software and cables, (IC640VPS00, IC752DDZ000, IC200CBL555)	Active
IC200TBX223	Tool box, Micro 23, Ethernet interface and software. Includes (IC200UAL006) 24 VDC In/Relay Out, requires 120 VAC Power, VersaMax SE (IC200SET001) with all software, cables (IC646MPH101) and manuals.	Active
IC200TBX028	Tool box, Micro 28 and software. Includes (IC200UDR005) 24 VDC In/Relay Out, AC Power Supply with software, manuals and cables (IC646MPH101)	Active
IC200TBX128	Tool box, Micro 28, operator interface and software. Includes (IC200UDR005) 24 VDC In/Relay Out, AC P/S, VersaMax DataPanel DP45 with programming software and cables, (IC640VPS00, IC752DDZ000, IC200CBL555)	Active
IC200TBX228	Tool box, Micro 28, Ethernet interface and software. Includes (IC200UDR005) 24 VDC In/Relay Out, requires 120 VAC Power, VersaMax SE (IC200SET001) with all software, cables (IC646MPH101) and manuals.	Active
IC200TBX020	Tool box, Micro 20 and software. Includes (IC200UDD020) 24VDC In/24VDC Out, DC Power Supply, (IC200USB001) RS-232 option board with (2) 0 -10VDC analog in with software, manuals and cables (IC646MPPM101)	Active
IC200TBX120	Tool box, Micro 20 and software. Includes (IC200UDR120) 24VDC In/Relay Out, AC Power Supply, (IC200USB001) RS-232 option board with (2) 0 -10VDC analog in with software, manuals and cables (IC646MPPM101)	Active
IC200TBX220	Tool box, Micro 20, operator interface and software. Includes (IC200UDD020) 24VDC In/24VDC Out, DC Power Supply, (IC200USB001) RS-232 option board with (2) 0 -10VDC analog in with VersaMax DataPanel DP45 with programming software and cables, (IC646MPPM101, IC752DDZ000, IC200CBL555)	Active
IC200TBX320	Tool box, Micro 20, operator interface and software. Includes (IC200UDR120) 24VDC In/Relay Out, AC Power Supply, (IC200USB001) RS-232 option board with (2) 0 -10VDC analog in with VersaMax DataPanel DP45 with Logic Developer programming software and cables, (IC646MPPM101, IC752DDZ000, IC200CBL555)	Active
IC200TBX520	Tool box, Micro 20, QuickPanel color touch screen and software. Includes (IC200UDR164) 24VDC In/Relay Out, AC Power Supply, (IC200UEM001) Ethernet option board, QuickPanel Display (IC754VSI06STD) with software, manuals and cables (BC646MBL001)	Active
IC200TBX040	Tool box, Micro 40 and software. Includes (IC200UDD040) 24VDC In/24VDC Out, DC Power Supply, (IC200USB001) RS-232 option board with (2) 0 -10VDC analog in with software, manuals and cables (IC646MPPM101)	Active
IC200TBX140	Tool box, Micro 40 and software. Includes (IC200UDR140) 24VDC In/Relay Out, AC Power Supply, (IC200USB001) RS-232 option board with (2) 0 -10VDC analog in with software, manuals and cables (IC646MPPM101)	Active
IC200TBX240	Tool box, Micro 40, operator interface and software. Includes (IC200UDD040) 24VDC In/24VDC Out, DC Power Supply, (IC200USB001) RS-232 option board with (2) 0 -10VDC analog in with VersaMax DataPanel DP45 with programming software and cables, (IC646MPPM101, IC752DDZ000, IC200CBL555)	Active
IC200TBX340	Tool box, Micro 40, operator interface and software. Includes (IC200UDR140) 24VDC In/Relay Out, AC Power Supply, (IC200USB001) RS-232 option board with (2) 0 -10VDC analog in with VersaMax DataPanel DP45 with Logic Developer programming software and cables, (IC646MPPM101, IC752DDZ000, IC200CBL555)	Active
IC200TBX540	Tool box, Micro 40, QuickPanel color touch screen and software. Includes (IC200UDR140) 24VDC In/Relay Out, AC Power Supply, (IC200UEM001) Ethernet option board, QuickPanel Display (IC754VSI06STD) with software, manuals and cables (BC646MBL001)	Active
IC200TBX064	Tool box, Micro 64 and software. Includes (IC200UDD064) 24 VDC In/24 VDC Out, DC Power Supply, (IC200USB001) RS-232 option board with (2) 0 -10 VDC analog in with software, manuals and cables (IC646MPPM101)	Active
IC200TBX164	Tool box, Micro 64 and software. Includes (IC200UDR164) 24 VDC In/Relay Out, AC Power Supply, (IC200USB001) RS-232 option board with (2) 0 -10 VDC analog in with software, manuals and cables (IC646MPPM101)	Active
IC200TBX264	Tool box, Micro 64, operator interface and software. Includes (IC200UDD064) 24 VDC In/24 VDC Out, DC Power Supply, (IC200USB001) RS-232 option board with (2) 0 -10 VDC analog in with VersaMax DataPanel DP45 with programming software and cables, (IC646MPPM101, IC752DDZ000, IC200CBL555)	Active
IC200TBX364	Tool box, Micro 64, operator interface and software. Includes (IC200UDR164) 24 VDC In/Relay Out, AC Power Supply, (IC200USB001) RS-232 option board with (2) 0 -10 VDC analog in with VersaMax DataPanel DP45 with Logic Developer programming software and cables, (IC646MPPM101, IC752DDZ000, IC200CBL555)	Active
IC200TBX564	Tool box, Micro 64, QuickPanel color touch screen and software. Includes (IC200UDR164) 24 VDC In/Relay Out, AC Power Supply, (IC200UEM001) Ethernet option board, QuickPanel Display (IC754VSI06STD) with software, manuals and cables (BC646MBL001)	Active

Configuration Guidelines

Examples of Typical Application

Configuration for Nano 10 (Applications needing less than 6 (24 VDC) inputs and 4 relay outputs)

Qty	Part Number	Description
1	IC200NDR001	10 point (6) 24 VDC In, (4) Relay Out, 24 VDC Powered
1	BC646MPPM101	Proficy Logic Developer - PLC Nano/Micro, Programming Cable included and GlobalCare Complete (Upgrades included for 15 months of upgrades)

Options to consider

1	IC200ACC450	Simulator for VersaMax Nano 10. (6 Inputs)
1	IC690PWR024	24 VDC, 5 Amp Output Power and 120/230 VAC Input Power Power Supply

Configuration for Micro 14 (Example Application needing 12 (24 VDC) discrete inputs, 6 relay outputs and 3 Analog inputs with 24 VDC power)

Qty	Part Number	Description
1	IC200UDR002	14 point (8) 24 VDC In, (6) Relay Out, 24 VDC Powered
1	IC200UEI008	8 point 24 VDC In, 24 VDC Powered
1	IC200UEX626	6 Analog I/O Channels (4) 0 to 10 VDC, ± 10 VDC, 4 to 20 mA, 0 to 20 mA In, (2) 0 to 10 VDC, 4 to 20 mA, 0 to 20 mA Out, 24 VDC Powered
1	BC646MPPM101	Proficy Logic Developer - PLC Nano/Micro, Programming Cable included and GlobalCare Complete (Upgrades included for 15 months of upgrades)

Options to consider

1	IC200UDR010	28 point (16) 24 VDC In, (12) Relay Out, 24 VDC Powered - advantage is two serial ports, Real Time clock and more data memory.
1	IC200ACC451	Simulator for VersaMax Micro 14, Micro 23 and Micro 28. (8 Inputs)
1	IC690PWR024	24 VDC, 5 Amp Output Power and 120/230 VAC Input Power Power Supply
1	IC200DTX650	Operator Interface with up to 200 stored messages. 4x16 character LCD backlight display and 8 function keys. Requires IC200CBL550 cable or equivalent. Operates on external 24 VDC @ 80 mA.

Configuration for Micro 28 (Example Application needing 22 (24 VDC) discrete inputs, 16 outputs [Ten Relay and Six 24 VDC], 2 RTD inputs, 1 Analog output using AC power. Also requires Display with keypad)

Qty	Part Number	Description
1	IC200UDR005	28 point; (16) 24 VDC In, (11) Relay Out, (1) 24 VDC Out, 120/240 VAC Powered.
1	IC200ACC403	Battery for Micro 23 and Micro 28 for data retention
1	IC200UEX014	14 point (8) 24 VDC In, (6) 24 VDC Out, 24 VDC Powered
1	IC200UEX736	4 RTD PT 100 Channels IN, 2 Analog Channels OUT 0 to 10 VDC, 4 to 20 mA, 0 to 20 mA Out, 120/240 VAC Powered
1	BC646MPPM101	Proficy Logic Developer - PLC Nano/Micro, Programming Cable included and GlobalCare Complete (Upgrades included for 15 months of upgrades)
1	IC200DTX850	Operator Interface with up to 200 stored messages. 4x20 character LCD backlight display, 8 function keys and numeric keypad. Requires IC200CBL550 cable or equivalent. Operates on external 24 VDC @ 50 mA.
1	IC752DDZ000	VersaMax DP Operator Interface DataDesigner editor

Options to consider

1	IC200ACC451	Simulator for VersaMax Micro 14, Micro 23 and Micro 28. (8 Inputs)
1	IC690PWR024	24 VDC, 5 Amp Output Power and 120/230 VAC Input Power Power Supply

Configuration for Micro 644 (Example Application needing 45 (24 VDC) discrete inputs, 32 outputs (Twelve Relay and Twenty 24 VDC), 2 Servo motors.
Application also requires Color Touch Graphic Display

Qty	Part Number	Description
1	IC200UDD064	Micro 64; (40) 24 VDC In, (24) 24 VDC Source Out 0.7 amps with ESCP protection, 24 VDC Power Supply.
1	IC200ACC414	Long Term Battery for Micro 23, Micro 28 and Micro 64
1	IC200UEX211	28 point (16) 24 VDC In, (12) Relay Out, 120/240 VAC Power Supply
1	IC200UEM001	Ethernet Module
1	IC200UMM002	2 Axis Motion Module
1	IC800VMM10LBKSE25	VersaMotion 1000 Watt Motor with brake
1	IC800VMA102	Servo Amplifier, 1000 Watts, 220 VAC
1	IC800VMCB1030	Brake and Power Cable for 1000 Watt Servo Motor and brake, 3 meters
1	IC800VMCE1030	Encoder Cable for 1000 Watt and greater, 3 meters
1	IC800VMTBC005	I/O terminal block and cable .5 meters
1	IC800VMCS030	Communications cable and servo driver to PC, 3 meters
1	IC754VSI06STD	QuickPanel View Intermediate 6 inch STN Touch
1	BC646MBL001	Machine Edition Lite Development Suite with Proficy GlobalCare Complete. Includes View Development for QuickPanel and LD-PLC Nano/Micro with 15 months of Proficy GlobalCare which is renewable on an annual basis.
1	IC200CBL500	Programming cable (RJ-45 to DB-9 pin) RS-232. 3 Meters.
Options to consider		
1	IC200UMB001	Flash Memory Board for program download and compatible with Micro 64 (128Kbytes)
1	IC690PWR124	24 VDC, 10 Amp Output Power and 120/230 VAC Input Power Power Supply

Durus Controllers

The Durus PLUS Controllers are loaded with features such as easy to use built-in display/keypad, high current outputs, and multiple communication options and very affordable. They can be programmed using both the built-in display and keypad or with the Durus Controllers programming software. The Durus PLUS Controllers are ideal for applications that require some logic, a few timers/counters and real-time clock control.

They provide added features such as math, PID and data move functionality. The Durus Plus Controllers are designed for simple control applications such as light control, gate control, HVAC, pump control and much more.

Key Features:

- Isolated 8 Amp Relay Outputs, analog in and out and temperature monitoring

- Support for Ethernet, Modbus Slave, PROFIBUS Slave and DeviceNet Slave
- Durus Controllers Software enables the user to fully simulate applications without the hardware
- Memory Module enables easy program downloads without a PC
- Software is free for downloading from the Web
- LCD Backlit display for easy viewing in all environments

- AC Models** pages 9.35-9.36
- DC Models** pages 9.37-9.40
- Discrete Expansion Units** page 9.41
- Analog Expansion Unit** page 9.42
- Communications Options** page 9.43
- Software** page 9.44
- Accessories** page 9.45
- Configuration Guidelines** page 9.46



- Backlit LCD Display**
- Keypad**
- Socket for memory module or communications interface cable**
- Optional Expansion (Up to 3 discrete and 1 analog expansion units)**

Durus Controllers Selection Guide

Features	Durus PLUS -10 and -12	Durus PLUS -20
Built-in Discrete I/O	6 in/4 out	12 in/8 out (AC powered models) 8 in/8 out (DC powered models)
Maximum Discrete I/O	18 in/16 out	24 in/20 out
Built-in Analog I/O	2 on DC powered models	4 on DC powered models
I/O Expansion Units	Maximum of eight expansion bases are supported. <ul style="list-style-type: none"> • Up to 3 Discrete I/O modules • 1 Analog input module • 1 Temperature input module (RTD) • Up to 2 Analog output modules • 1 Communications module 	
Logic Memory	300 Lines (4 cells wide per rung) or 260 Function Blocks	
Programming Language	Ladder or Function Block Diagram (FBD)	
Execution Speed	10ms/cycle	
LCD Display	4 line x16 character LCD backlit display	
Maximum Text Displays	31	
Display Languages	English, French, German, Spanish, Portuguese, Chinese, Italian	
Address Assignments	Up to 32 discrete inputs and 146 outputs; 8 analog inputs, 4 RTD inputs and 4 analog outputs; 240 registers (16 bit signed or unsigned)	
Coils	63 Auxiliary M, 63 Auxiliary N Coils and 31 HMI Coils	
Real Time Clock	Up to 15 uses (250 FBD)	
Number of Timers	Up to 31; 0.01seconds to 9999 minutes (250 FBD)	
Number of Counters	Up to 31; 0 to 999999 counts (250 FBD)	
Math Functions	Up to 31: Add, Subtract (250 FBD); Up to 31 Multiply, Divide (250 FBD)	
PID	Up to 15: PI and PID (30 FBD)	
Data Multiplexer	Up to 15: Four registers deep (250 FBD)	
Analog Ramp Control	Up to 15: Multiple steps supported (30 FBD)	
Comparator Instruction	Up to 31; Supports <= or >= for Timers, Counters or Analog (250 FBD)	
High Speed Input Frequency	1kHz	
PWM Output Frequency	0.5kHz (1msec On, 1msec Off)	
Modbus Master Built-in	No	Yes on selective models
Modbus Slave Support Built-in	No	
Modbus Slave Support	Yes (built-in on certain models and available for all controllers that support expansion (Modbus Slave expansion module)	
PROFIBUS Slave Support	Yes	
DeviceNet Slave Support	Yes	
Agency Approvals	CE, C-UL, UL	
Temperature Range	0°C to 55°C	



AC Models

The AC versions of the Durus Controllers come with 10 points (6 discrete inputs and 4 discrete outputs) or 20 points (12 discrete inputs and 8 discrete outputs). The units are available with or without display and keypad and with or without expansion. Up to 3 discrete and 1 analog expansion units can be added for either additional I/O. One communication module can be added.

	IC210DAR012	IC210DAR010	IC210BAR010	IC210NAR010
Product Name	10 point (8) 24 VAC Inputs, (4) Isolated Relay Out (8 Amps), 24 VAC input power, supports expansion and display/keypad	10 point (6) AC Inputs, (4) Isolated Relay Out (8 Amps), AC input power, supports expansion and display/keypad	10 point (6) AC Inputs, (4) Isolated Relay Out (8 Amps), AC input power, supports expansion and no display/keypad	10 point (6) AC Inputs, (4) Isolated Relay Out (8 Amps), AC input power, no expansion, no plastic case and no display/keypad
Lifecycle Status	Mature	Mature	Mature	Mature
Number of Discrete Inputs/Outputs	8 In/ 4 Out	6 In/ 4 Out	6 In/ 4 Out	6 In/ 4 Out
Number of Analog Inputs/Outputs	None built in, 4 with Analog Expansion	None built in, 4 with Analog Expansion	None built in, 4 with Analog Expansion	None
Physical I/O Maximum	34 I/O	34 I/O	34 I/O	34 I/O
Support Expansion	Yes	Yes	Yes	No
LCD Display and Keypad	Yes (4 lines x 12 characters)	Yes (4 lines x 12 characters)	No	No
User Program Logic Memory	200 Rungs and 99 Blocks	200 Rungs and 99 Blocks	200 Rungs and 99 Blocks	200 Rungs and 99 Blocks
Protocols Supported	Modbus Slave, DeviceNet Slave, PROFIBUS Slave expansion modules	Modbus Slave, DeviceNet Slave, PROFIBUS Slave expansion modules	Modbus Slave, DeviceNet Slave, PROFIBUS Slave expansion modules	None
Input Power Voltage	24 VAC	85 to 240 VAC; 85 to 240 VDC	85 to 240 VAC; 85 to 240 VDC	85 to 240 VAC; 85 to 240 VDC
Power Supply Power Consumption	90 mAmps	90 mAmps	90 mAmps	90 mAmps
Input Device Voltage	24 VAC	85 to 240 VAC; 85 to 240 VDC	85 to 240 VAC; 85 to 240 VDC	85 to 240 VAC
Output Control Voltage	250 VAC / 30 VDC Relay Outputs, 8A Resistive Load (Isolated)	250 VAC / 30 VDC Relay Outputs, 8A Resistive Load (Isolated)	250 VAC / 30 VDC Relay Outputs, 8A Resistive Load (Isolated)	250 VAC / 30 VDC Relay Outputs, 8A Resistive Load (Isolated)
Dimensions (W x H x D) mm	72 mm x 90 mm x 58 mm	72 mm x 90 mm x 58 mm	72 mm x 90 mm x 58 mm	72 mm x 90 mm x 58 mm



AC Models

The AC versions of the Durus Controllers come with 10 points (6 discrete inputs and 4 discrete outputs) or 20 points (12 discrete inputs and 8 discrete outputs). The units are available with or without display and keypad and with or without expansion. Up to 3 discrete and 1 analog expansion units can be added for either additional I/O. One communication module can be added.

	IC210DAR020	IC210BAR020	IC210NAR020
Product Name	20 point (12) AC Inputs, (8) Isolated Relay Out (8 Amps), AC input power, supports expansion and display/keypad	20 point (12) AC Inputs, (8) Isolated Relay Out (8 Amps), AC input power, supports expansion and no display/keypad	20 point (12) AC Inputs, (8) Isolated Relay Out (8 Amps), AC input power, no expansion and no display/keypad
Lifecycle Status	Mature	Mature	Mature
Number of Discrete Inputs/Outputs	12 In/ 8 Out	12 In/ 8 Out	12 In/ 8 Out
Number of Analog Inputs/Outputs	None built in, 4 with Analog Expansion	None built in, 4 with Analog Expansion	None
Physical I/O Maximum	44 I/O	44 I/O	44 I/O
Support Expansion	Yes	Yes	No
LCD Display and Keypad	Yes (4 lines x 12 characters)	No	No
User Program Logic Memory	200 Rungs and 99 Blocks	200 Rungs and 99 Blocks	200 Rungs and 99 Blocks
Protocols Supported	Modbus Slave, DeviceNet Slave, PROFIBUS Slave expansion modules	Modbus Slave, DeviceNet Slave, PROFIBUS Slave expansion modules	None
Input Power Voltage	85 to 240 VAC; 85 to 240 VDC	85 to 240 VAC; 85 to 240 VDC	85 to 240 VAC; 85 to 240 VDC
Power Supply Power Consumption	150 mAmps	150 mAmps	150 mAmps
Input Device Voltage	85 to 240 VAC; 85 to 240 VDC	85 to 240 VAC; 85 to 240 VDC	85 to 240 VAC; 85 to 240 VDC
Output Control Voltage	250 VAC / 30 VDC Relay Outputs, 8A Resistive Load (Isolated)	250 VAC / 30 VDC Relay Outputs, 8A Resistive Load (Isolated)	250 VAC / 30 VDC Relay Outputs, 8A Resistive Load (Isolated)
Dimensions (W x H x D) mm	126 mm x 90 mm x 58 mm	126 mm x 90 mm x 58 mm	126 mm x 90 mm x 58 mm

DC Models

The DC versions of the Durus Controllers come in either 12 point (6 discrete inputs, 2 analog and 4 discrete outputs) or 20 point (12 discrete inputs [analog inputs can be configured as either discrete inputs or analog inputs], 4 analog inputs and 8 discrete outputs). The units also support high speed inputs and PWM outputs. The units are available with or without display and keypad and with or without expansion. Up to 3 discrete and 1 analog expansion units can be added for either additional I/O. One communication module can be added.



	IC210DDR112	IC210DDR012	IC210BDR012	IC210NDR012
Product Name	10 point (6) 12 VDC Inputs, (2) analog inputs*, (4) Isolated Relay Out (8 Amps), 12 VDC input power, supports expansion and display/keypad	10 point (6) 24 VDC Inputs, (2) analog inputs*, (4) Isolated, Relay Out (8 Amps), 24 VDC input power, supports expansion and display/keypad	10 point (6) 24 VDC Inputs, (2) analog inputs*, (4) Isolated, Relay Out (8 Amps), 24 VDC input power, supports expansion and display/keypad	10 point (6) 24 VDC Inputs, (2) analog inputs*, (4) Isolated, Relay Out (8 Amps), 24 VDC input power, no expansion, no plastic case and no display/keypad
Lifecycle Status	Mature	Mature	Mature	Mature
Number of Discrete Inputs/Outputs	6* In/ 4 Out	6* In/ 4 Out	6* In/ 4 Out	6* In/ 4 Out
Number of Analog Inputs/Outputs	2 built in, 4 additional with Analog Expansion	2 built in, 4 additional with Analog Expansion	2 built in, 4 additional with Analog Expansion	2 built in
Physical I/O Maximum	36 I/O	36 I/O	36 I/O	36 I/O
Support Expansion	Yes	Yes	Yes	No
LCD Display and Keypad	Yes (4 lines x 12 characters)	Yes (4 lines x 12 characters)	No	No
User Program Logic Memory	200 Rungs and 99 Blocks	200 Rungs and 99 Blocks	200 Rungs and 99 Blocks	200 Rungs and 99 Blocks
Protocols Supported	Modbus Slave, DeviceNet Slave, PROFIBUS Slave expansion modules	Modbus Slave, DeviceNet Slave, PROFIBUS Slave expansion modules	Modbus Slave, DeviceNet Slave, PROFIBUS Slave expansion modules	None
Input Power Voltage	12 VDC	24 VDC	24 VDC	24 VDC
Power Supply Power Consumption	90 mAmps	90 mAmps	90 mAmps	90 mAmps
Input Device Voltage	12 VDC	24 VDC	24 VDC	24 VDC
High Speed Frequency	1KHz	1KHz	1KHz	1KHz
Output Control Voltage	250 VAC / 30 VDC Relay Outputs, 8A Resistive Load (Isolated)	250 VAC / 30 VDC Relay Outputs, 8A Resistive Load (Isolated)	250 VAC / 30 VDC Relay Outputs, 8A Resistive Load (Isolated)	250 VAC / 30 VDC Relay Outputs, 8A Resistive Load (Isolated)
PWM Maximum Output Frequency	N/A	N/A	N/A	N/A
Analog Resolution	10 bits	10 bits	10 bits	10 bits
Analog Input Range	0 to 10 VDC	0 to 10 VDC	0 to 10 VDC	0 to 10 VDC
Analog Input Used as Digital Input	Input Current: 0.63 mA @ 24 VDC Input ON Current: 0.161 mA @ 9.8 VDC Input OFF Current: 0.085 mA @ 5 VDC	Input Current: 0.63 mA @ 24 VDC Input ON Current: 0.161 mA @ 9.8 VDC Input OFF Current: 0.085 mA @ 5 VDC	Input Current: 0.63 mA @ 24 VDC Input ON Current: 0.161 mA @ 9.8 VDC Input OFF Current: 0.085 mA @ 5 VDC	Input Current: 0.63 mA @ 24 VDC Input ON Current: 0.161 mA @ 9.8 VDC Input OFF Current: 0.085 mA @ 5 VDC
Dimensions (W x H x D) mm	72 mm x 90 mm x 58 mm	72 mm x 90 mm x 58 mm	72 mm x 90 mm x 58 mm	72 mm x 90 mm x 58 mm

*Analog inputs can be configured as DC input points.

DC Models



The DC versions of the Durus Controllers come in either 12 point (6 discrete inputs, 2 analog and 4 discrete outputs) or 20 point (12 discrete inputs [analog inputs can be configured as either discrete inputs or analog inputs], 4 analog inputs and 8 discrete outputs). The units also support high speed inputs and PWM outputs. The units are available with or without display and keypad and with or without expansion. Up to 3 discrete and 1 analog expansion units can be added for either additional I/O. One communication module can be added.

	IC210DDD012	IC210BDD012	IC210NDD012	IC210MDR124
Product Name	10 point (6) 24 VDC Inputs, (4) 24 VDC Out (Transistor 0.5 Amp), (2) analog inputs*, 24 VDC input power, supports expansion and display/keypad	10 point (6) 24 VDC Inputs, (4) 24 VDC Out (Transistor 0.5 Amp), (2) analog inputs*, 24 VDC input power, supports expansion, no display/keypad	10 point (6) 24 VDC Inputs, (4) 24 VDC Out (Transistor 0.5 Amp), (2) analog inputs*, 24 VDC input power, no expansion, no plastic case and no display/keypad	20 point with Modbus Slave communications built-in (8) 12 VDC Inputs, (4) analog inputs*, (8) Isolated Relay Out (8 Amps), 12 VDC input power, supports expansion and display/keypad
Lifecycle Status	Mature	Mature	Mature	Mature
Number of Discrete Inputs/Outputs	6* In/ 4 Out	6* In/ 4 Out	6* In/ 4 Out	8* In/ 8 Out
Number of Analog Inputs/Outputs	2 built in, 4 additional with Analog Expansion	2 built in, 4 additional with Analog Expansion	2 built in	4 built in, 4 with Analog Expansion
Physical I/O Maximum	36 I/O	36 I/O	36 I/O	44 I/O
Support Expansion	Yes	Yes	No	Yes
LCD Display and Keypad	Yes (4 lines x 12 characters)	No	No	Yes (4 lines x 12 characters)
User Program Logic Memory	200 Rungs and 99 Blocks	200 Rungs and 99 Blocks	200 Rungs and 99 Blocks	200 Rungs and 99 Blocks
Protocols Supported	Modbus Slave, DeviceNet Slave, PROFIBUS Slave expansion modules	Modbus Slave, DeviceNet Slave, PROFIBUS Slave expansion modules	None	Modbus Slave built in, and Modbus Slave, DeviceNet Slave, PROFIBUS Slave expansion modules
Input Power Voltage	24 VDC	24 VDC	24 VDC	12 VDC
Power Supply Power Consumption	90 mAmps	90 mAmps	90 mAmps	90 mAmps
Input Device Voltage	24 VDC	24 VDC	24 VDC	12 VDC
High Speed Frequency	1KHz	1KHz	1KHz	1KHz
Output Control Voltage	24 VDC Transistors	24 VDC Transistors	24 VDC Transistors	250 VAC / 30 VDC Relay Outputs, 8A Resistive Load (Isolated)
PWM Maximum Output Frequency	0.5K (1ms ON/ 1ms OFF)	100 Hz	100 Hz	N/A
Analog Resolution	10 bits	10 bits	10 bits	10 bits
Analog Input Range	0 to 10 VDC	0 to 10 VDC	0 to 10 VDC	0 to 10 VDC
Analog Input Used as Digital Input	Input Current: 0.63 mA @ 24 VDC Input ON Current: 0.161 mA @ 9.8 VDC Input OFF Current: 0.085 mA @ 5 VDC	Input Current: 0.63 mA @ 24 VDC Input ON Current: 0.161 mA @ 9.8 VDC Input OFF Current: 0.085 mA @ 5 VDC	Input Current: 0.63 mA @ 24 VDC Input ON Current: 0.161 mA @ 9.8 VDC Input OFF Current: 0.085 mA @ 5 VDC	Input Current: 0.63 mA @ 24 VDC Input ON Current: 0.161 mA @ 9.8 VDC Input OFF Current: 0.085 mA @ 5 VDC
Dimensions (W x H x D) mm	72 mm x 90 mm x 58 mm	72 mm x 90 mm x 58 mm	72 mm x 90 mm x 58 mm	126 mm x 90 mm x 58 mm

*Analog inputs can be configured as DC input points.

DC Models



The DC versions of the Durus Controllers come in either 12 point (6 discrete inputs, 2 analog and 4 discrete outputs) or 20 point (12 discrete inputs [analog inputs can be configured as either discrete inputs or analog inputs], 4 analog inputs and 8 discrete outputs). The units also support high speed inputs and PWM outputs. The units are available with or without display and keypad and with or without expansion. Up to 3 discrete and 1 analog expansion units can be added for either additional I/O. One communication module can be added.

	IC210DDR024	IC210BDR024	IC210NDR024	IC210DDR024
Product Name	20 point (8) 24 VDC Inputs, (4) analog inputs*, (8) Isolated Relay Out (8 Amps), 24 VDC input power, supports expansion and display/keypad	20 point (8) 24 VDC Inputs, (4) analog inputs*, (8) Isolated Relay Out (8 Amps), 24 VDC input power, supports expansion, no display/keypad	20 point (8) 24 VDC Inputs, (4) analog inputs*, (8) Isolated Relay Out (8 Amps), 24 VDC input power, no expansion, no plastic case and no display/keypad	20 point (4) 24 VDC Inputs, (8) 24 VDC Out (Transistor 0.5 Amp), (4) analog inputs*, 24 VDC input power, supports expansion and display/keypad
Lifecycle Status	Mature	Mature	Mature	Mature
Number of Discrete Inputs/Outputs	8* In/ 8 Out	8* In/ 8 Out	8* In/ 8 Out	8* In/ 8 Out
Number of Analog Inputs/Outputs	4 built in, 4 with Analog Expansion	4 built in, 4 with Analog Expansion	4 built in	4 built in, 4 with Analog Expansion
Physical I/O Maximum	44 I/O	44 I/O	44 I/O	44 I/O
Support Expansion	Yes	Yes	No	Yes
LCD Display and Keypad	Yes (4 lines x 12 characters)	No	No	Yes (4 lines x 12 characters)
User Program Logic Memory	200 Rungs and 99 Blocks	200 Rungs and 99 Blocks	200 Rungs and 99 Blocks	200 Rungs and 99 Blocks
Protocols Supported	Modbus Slave, DeviceNet Slave, PROFIBUS Slave expansion modules	Modbus Slave, DeviceNet Slave, PROFIBUS Slave expansion modules	None	Modbus Slave, DeviceNet Slave, PROFIBUS Slave expansion modules
Input Power Voltage	24 VDC	24 VDC	24 VDC	24 VDC
Power Supply Power Consumption	90 mAmps	90 mAmps	90 mAmps	90 mAmps
Input Device Voltage	24 VDC	24 VDC	24 VDC	24 VDC
High Speed Frequency	1KHz	1KHz	1KHz	1KHz
Output Control Voltage	250 VAC / 30 VDC Relay Outputs, 8A Resistive Load (Isolated)	250 VAC / 30 VDC Relay Outputs, 8A Resistive Load (Isolated)	250 VAC / 30 VDC Relay Outputs, 8A Resistive Load (Isolated)	24 VDC Transistors
PWM Maximum Output Frequency	N/A	N/A	N/A	100 Hz
Analog Resolution	10 bits	10 bits	10 bits	10 bits
Analog Input Range	0 to 10 VDC	0 to 10 VDC	0 to 10 VDC	0 to 10 VDC
Analog Input Used as Digital Input	Input Current: 0.63 mA @ 24 VDC Input ON Current: 0.161 mA @ 9.8 VDC Input OFF Current: 0.085 mA @ 5 VDC	Input Current: 0.63 mA @ 24 VDC Input ON Current: 0.161 mA @ 9.8 VDC Input OFF Current: 0.085 mA @ 5 VDC	Input Current: 0.63 mA @ 24 VDC Input ON Current: 0.161 mA @ 9.8 VDC Input OFF Current: 0.085 mA @ 5 VDC	Input Current: 0.63 mA @ 24 VDC Input ON Current: 0.161 mA @ 9.8 VDC Input OFF Current: 0.085 mA @ 5 VDC
Dimensions (W x H x D) mm	126 mm x 90 mm x 58 mm	126 mm x 90 mm x 58 mm	126 mm x 90 mm x 58 mm	126 mm x 90 mm x 58 mm

* Analog inputs can be configured as DC input points.

DC Models

The DC versions of the Durus Controllers come in either 12 point (6 discrete inputs, 2 analog and 4 discrete outputs) or 20 point (12 discrete inputs [analog inputs can be configured as either discrete inputs or analog inputs], 4 analog inputs and 8 discrete outputs). The units also support high speed inputs and PWM outputs. The units are available with or without display and keypad and with or without expansion. Up to 3 discrete and 1 analog expansion units can be added for either additional I/O. One communication module can be added.



	IC210BDD024	IC210NDD024	IC210MDR024	IC210MDD024
Product Name	20 point (8) 24 VDC Inputs, (8) 24 VDC Out (Transistor 0.5 Amp), (4) analog inputs*, 24 VDC input power, supports expansion, no display/keypad	20 point (8) 24 VDC Inputs, (8) 24 VDC Out (Transistor 0.5 Amp), (4) analog inputs*, 24 VDC input power, no expansion, no plastic case and no display/keypad	20 point with Modbus Slave communications built-in (8) 24 VDC Inputs, (4) analog inputs*, (8) Isolated Relay Out (8 Amps), 24 VDC input power, supports expansion and display/keypad	20 point Modbus Slave communications built-in (8) 24 VDC Inputs, (8) 24 VDC Out (Transistor 0.5 Amp), (4) analog inputs*, 24 VDC input power, supports expansion and display/keypad
Lifecycle Status	Mature	Mature	Mature	Mature
Number of Discrete Inputs/Outputs	8* In/ 8 Out	8* In/ 8 Out	8* In/ 8 Out	8* In/ 8 Out
Number of Analog Inputs/Outputs	4 built in, 4 with Analog Expansion	4 built in	4 built in, 4 with Analog Expansion	4 built in, 4 with Analog Expansion
Physical I/O Maximum	44 I/O	44 I/O	44 I/O	44 I/O
Support Expansion	Yes	No	Yes	Yes
LCD Display and Keypad	No	No	Yes (4 lines x 12 characters)	Yes (4 lines x 12 characters)
User Program Logic Memory	200 Rungs and 99 Blocks	200 Rungs and 99 Blocks	200 Rungs and 99 Blocks	200 Rungs and 99 Blocks
Protocols Supported	Modbus Slave, DeviceNet Slave, PROFIBUS Slave expansion modules	None	Modbus Slave built in, and Modbus Slave, DeviceNet Slave, PROFIBUS Slave expansion modules	Modbus Slave built in, and Modbus Slave, DeviceNet Slave, PROFIBUS Slave expansion modules
Input Power Voltage	24 VDC	24 VDC	24 VDC	24 VDC
Power Supply Power Consumption	90 mAmps	90 mAmps	90 mAmps	90 mAmps
Input Device Voltage	24 VDC	24 VDC	24 VDC	24 VDC
High Speed Frequency	1KHz	1KHz	1KHz	1KHz
Output Control Voltage	24 VDC Transistors	24 VDC Transistors	250 VAC / 30 VDC Relay Outputs, 8A Resistive Load (Isolated)	24 VDC Transistors
PWM Maximum Output Frequency	100 Hz	100 Hz	N/A	100 Hz
Analog Resolution	10 bits	10 bits	10 bits	10 bits
Analog Input Range	0 to 10 VDC	0 to 10 VDC	0 to 10 VDC	0 to 10 VDC
Analog Input Used as Digital Input	Input Current: 0.63 mA @ 24 VDC Input ON Current: 0.161 mA @ 9.8 VDC Input OFF Current: 0.085 mA @ 5 VDC	Input Current: 0.63 mA @ 24 VDC Input ON Current: 0.161 mA @ 9.8 VDC Input OFF Current: 0.085 mA @ 5 VDC	Input Current: 0.63 mA @ 24 VDC Input ON Current: 0.161 mA @ 9.8 VDC Input OFF Current: 0.085 mA @ 5 VDC	Input Current: 0.63 mA @ 24 VDC Input ON Current: 0.161 mA @ 9.8 VDC Input OFF Current: 0.085 mA @ 5 VDC
Dimensions (W x H x D) mm	126 mm x 90 mm x 58 mm	126 mm x 90 mm x 58 mm	126 mm x 90 mm x 58 mm	126 mm x 90 mm x 58 mm

* Analog inputs can be configured as DC input points.



Discrete Expansion Units

The Durus Controllers support a maximum of 7 I/O expansion modules and 1 communications module. The expansion supports a maximum of 3 discrete modules, 1 analog input module, 1 temperature input module (RTD), and 2 analog output expansion units.

	IC210EAR008	IC210EAR208	IC210EDR008	IC210EDD008
Product Name	8 point discrete expansion (4) AC Inputs, (4) Isolated Relay Out (8 Amps), AC input power	8 point discrete expansion (4) 24 VAC Inputs, (4) Isolated Relay Out (8 Amps), AC input power	8 point discrete expansion (4) 24 VDC Inputs, (4) Isolated Relay Output (8 Amps), 24 VDC input power	8 point discrete expansion (4) 24 VDC Inputs, (4) 24 VDC Out (Transistor 0.5 Amp), 24 VDC input power
Lifecycle Status	Mature	Mature	Mature	Mature
Number of Discrete Inputs/Outputs	4 In/ 4 Out	4 In/ 4 Out	4 In/ 4 Out	4 In/ 4 Out
Input Power Voltage	85 to 240 VAC; 85 to 240 VDC	24 VAC	24 VDC	24 VDC
Power Supply Power Consumption	90 mAmps	90 mAmps	90 mAmps	90 mAmps
Input Device Voltage	85 to 240 VAC; 85 to 240 VDC	24 VAC	24 VDC	24 VDC
Dimensions (W x H x D) mm	38 mm x 90 mm x 58 mm	38 mm x 90 mm x 58 mm	38 mm x 90 mm x 58 mm	38 mm x 90 mm x 58 mm



Analog Expansion Unit

The Durus Controllers support a maximum of 7 I/O expansion modules and 1 communications module. The total expansion supports 3 discrete modules, 1 analog input module, 1 temperature input module (RTD), and 2 analog output expansion units.

	IC210EAI004	IC210EPT004	IC210EAO002
Product Name	4 point analog expansion (4) analog inputs (voltage and current, 12 bit), 12/24 VDC input power Only one analog expansion supported on the Durus Controller	4 channel PT 100, 12bit, PT100 (-100°~600°). Maximum of temperature modules supported on the Durus Controller.	2 channel analog out expansion (0 - 10VDC or 0 - 20 mA). Maximum of 2 analog output modules supported on the Durus Controller.
Lifecycle Status	Mature	Mature	Mature
Number of Channels	4	4	
Input Type			
Output Type			
Analog Input Range	0 to 10 VDC; 0 to 20 mA		
Analog Output Range			0 to 10 VDC 0 to 20 mA
Resolution	12 bits	0.1C	10mV for Voltage 40 micro Amps for Current
Analog Output Register Range			10mV for Voltage 40 micro Amps for Current
Temperature Range	-100 to 600C		
Dimensions (W x H x D) mm	38 mm x 90 mm x 58 mm	38 mm x 90 mm x 58 mm	38 mm x 90 mm x 58 mm



Communications Options

The Durus Controllers support one communication expansion unit. There are three communication options available—Modbus Slave, PROFIBUS Slave and DeviceNet Slave.

	IC210EMS001	IC210EPS001	IC210EDS001
Product Name	Modbus RTU slave communications expansion module, 24 VDC power source	PROFIBUS-DP slave communications expansion module, 24 VDC power source	DeviceNet slave communications expansion module, 24 VDC power source
Lifecycle Status	Mature	Mature	Mature
Protocol Supported	Modbus Slave	PROFIBUS-DP Slave V0	DeviceNet Group 2 Only Slave Device
Network Data Rate	4800, 9600, 19200, 38400, 57600	9.6K to 12 Meg	125K, 250K, 500 K
Connector Type			
Dimensions (W x H x D) mm	38 mm x 90 mm x 58 mm	38 mm x 90 mm x 58 mm	38 mm x 90 mm x 58 mm

Software

Full featured Durus Software (IC646DUR001) enables you to develop your application in ladder logic or Function Block Diagram programming. The Durus Software also comes with a powerful simulation tool that enables you to easily simulate your application and mimic the keystrokes on the built-in operator keypad.

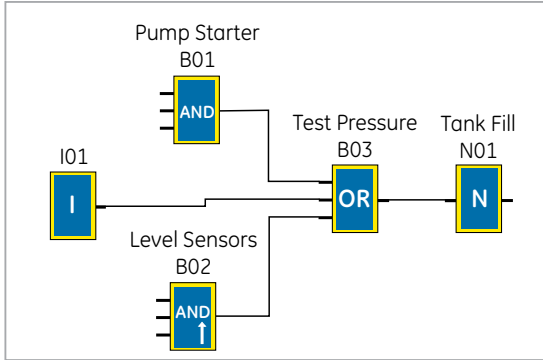

Function Block Diagram

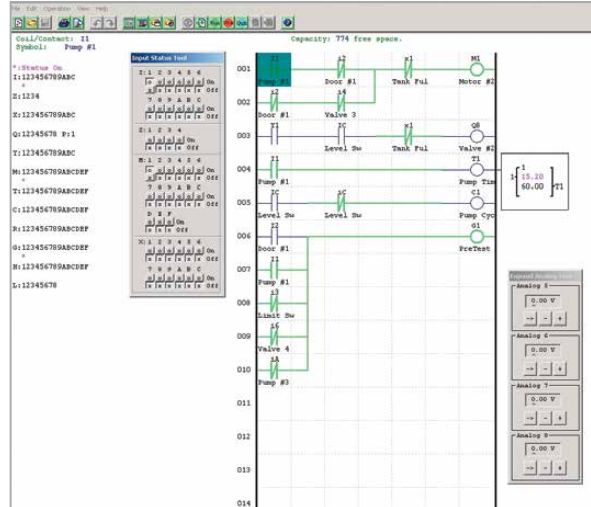

Ladder Logic

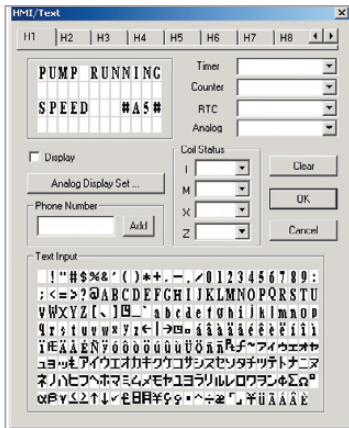

I/O Addressing

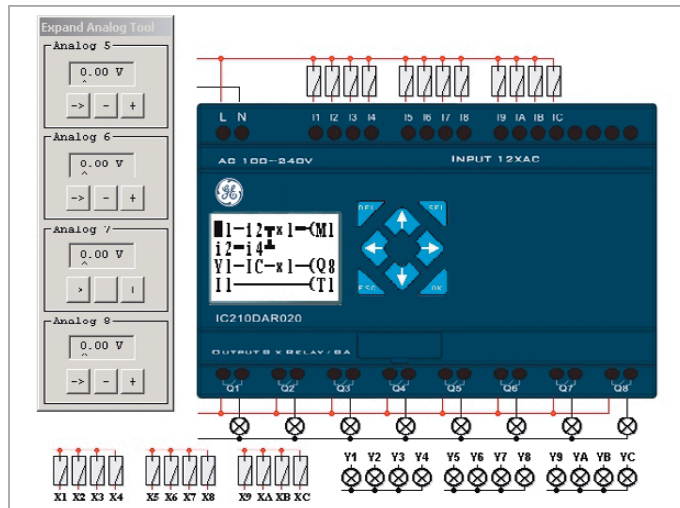

Easy-to-Use Application Development Simulation on the PC.

User can simulate your entire application without powering up a Durus Controller.

Accessories and Cables

Part Number	Description	Lifecycle Status
IC210TMP001	Durus Controllers FLASH Memory Pack that enables user to download application and upload application to Durus Controller	Mature
IC210CBL001	Durus Controller to PC RS-232 Serial Cable	Mature
IC210CBL002	Durus Controller to PDA Transfer Cable	Mature

Programming and Trouble Shooting Tools

Part Number	Description	Lifecycle Status
IC646DUR101	Durus Controllers Program and Simulation Software and PC to Controller RS-232 Cable (IC646DUR001 and IC210CBL001)	Mature

Starter Kits

Part Number	Description	Lifecycle Status
IC210TBX010	IC210DAR010 10 point Durus controller. AC Power Source, 6 AC in/4out (Relay 8 Amp), Expandable, with LCD/Keypad. Kit includes programming software and cable. (IC646DUR101)	Mature
IC210TBX012	IC210DDR012 12 point Durus controller. 24 VDC Power Source, (6) 24 VDC in / (4) out (Relay 8 Amp), (2) analog inputs, Expandable, with LCD/Keypad. Kit includes programming software and cable. (IC646DUR101)	Mature
IC210TBX020	IC210DAR020 20 point Durus controller. AC Power Source, (12) AC in/8 out (Relay, 8 Amp), Expandable, with LCD/Keypad. Kit includes programming software and cable. (IC646DUR101)	Mature
IC210TBX024	IC210DDR024 20 point Durus-20 controller. 24 point 24 VDC Power Source, (8) 24 VDC in/8 out (Relay, 8 Amp), (4) analog inputs, Expandable, with LCD/Keypad. Kit includes programming software and cable. (IC646DUR101)	Mature
IC210TBX124	IC210MDR024 20 point Durus-20 controller. 24 VDC Power Source, (8) 24 VDC in/8 out (Relay, 8 Amp), (4) analog inputs, Expandable, with LCD/Keypad. Support Modbus Slave on port. Kit includes programming software and cable. (IC646DUR101)	Mature

Examples of Typical Application using a Series 90-30

Configuration for Durus Controller 10 (Applications needing less than 6 (120/240 VAC) inputs and 4 relay outputs)

Qty	Part Number	Description
1	IC210DAR010	AC Power Source, 6 AC in/4 out (Relay 8 Amp), Expandable, with LCD/Keypad

Options to consider

1	IC646DUR101	Durus Controllers Program and Simulation Software and PC to Controller RS-232 Cable (IC646DUR001 and IC210CBL001)
1	IC210TMP001	Durus Controllers FLASH Memory Pack that enables user to download application and upload application to Durus Controllers
1	IC210EMS001	Modbus RTU slave communications expansion module, 24 VDC power source
1	IC200DTX450	Operator Interface with up to 200 stored messages. 2 x 16 character LCD backlight display and 6 function keys. (Requires 24 VDC power supply)

Configuration for Durus Controller 10 (Example Application needing 16 (24 VDC) discrete inputs, 12 relay outputs and 8 Analog inputs with 24 VDC power and Modbus communications. Modbus communications will connect to Operator Interface that requires 4 x 20 line display and numeric keypad)

Qty	Part Number	Description
1	IC210MDR024	24 VDC Power Source, (12) 24 VDC in/8 out (Relay, 8 Amp), (4) analog inputs, Expandable, with LCD/Keypad. Support Modbus Slave on port.
2	IC210EDR008	24 VDC Power Source, (4) 24 VDC in/(4) out (Relay, 8 Amp)
1	IC210EAI004	24 VDC power source, 10 bit, 4 Analog input
1	IC200DTX850	Operator Interface with up to 200 stored messages. 4 x 20 character LCD backlight display, 8 function keys and numeric keypad.

Options to consider

1	IC646DUR101	Durus Controllers Program and Simulation Software and PC to Controller RS-232 Cable (IC646DUR001 and IC210CBL001)
1	IC210TMP001	Durus Controllers FLASH Memory Pack that enables user to download application and upload application to Durus Controllers

Application requiring six 24 VDC inputs, eight AC inputs, thirteen relay outputs, no display required and PROFIBUS networking.

Qty	Part Number	Description
1	IC210BAR020	AC Power Source, (12) AC in/8 out (Relay, 8 Amp), Expandable, with without LCD/Keypad
2	IC210EDR008	24 VDC Power Source, (4) 24 VDC in/(4) out (Relay, 8 Amp)
1	IC210EPS001	PROFIBUS-DP slave communications expansion module, 24 VDC power source

Options to consider

1	IC646DUR101	Durus Controllers Program and Simulation Software and PC to Controller RS-232 Cable (IC646DUR001 and IC210CBL001)
1	IC210TMP001	Durus Controllers FLASH Memory Pack that enables user to download application and upload application to Durus Controllers

Series 90-30 PLCs

The Series 90-30 PLCs are a family of controllers, I/O systems and specialty modules designed to meet the demand for versatile industrial solutions. With a single overall control architecture and modular design, the Series 90-30 is trusted worldwide in such applications as high speed packaging, material handling, complex motion control, water treatment, continuous emissions monitoring, mining, food processing, elevator control, injection molding, and many more.

One reason for the versatility of the Series 90-30 is the large variety of discrete and analog I/O modules (over 100 modules), as well as specialty modules, that are available. In addition, GE offers a wide range of high-level communication options, from a simple serial connection to a high-speed Ethernet interface and a number of bus modules.

Machine Edition

Machine Edition is an advanced software environment for the development and maintenance of machine level automation. Visualization, motion control, and execution logic are developed with a single programmer.



CPUs [pages 9.48-9.50](#)

Baseplates [page 9.51](#)

Power Supplies [pages 9.52-9.53](#)

Serial Communications Modules [page 9.75](#)

Accessories [pages 9.82-9.83](#)

Configuration Guidelines [page 9.84](#)

Networks and Distributed I/O Systems [pages 9.72-9.74](#)

Specialty Modules [pages 9.66-9.71](#)

Analog I/O Modules (input) [pages 9.57-9.58](#)

Analog I/O Modules (output) [pages 9.64-9.65](#)

Discrete I/O Modules (input) [pages 9.54-9.56](#)

Discrete I/O Modules (output) [pages 9.59-9.63](#)

Power Measurement Modules [page 9.76](#)

Pneumatic Module [page 9.77](#)

Motion Modules [pages 9.79-9.80](#)

Expansion Modules [page 9.81](#)

Publication Reference Chart

GFK-0255	Series 90 Programmable Coprocessor Module & Support Software User's Manual
GFK-0293	Series 90-30 High Speed Counter User's Manual
GFK-0356	Series 90-30 PLC Installation and Hardware Manual
GFK-0412	Series 90-30 Genius Communications Module User's Manual
GFK-0467	Series 90-30/20/Micro PLC CPU Instruction Set Reference Manual
GFK-0529	Series 90 PLC SNP Communications User's Manual
GFK-0582	Series 90 PLC Serial Communications Driver User's Manual
GFK-0585	Series 90 PLC SNP Communications Driver User's Manual
GFK-0631	Series 90-30 I/O Link Slave Interface User's Manual
GFK-0664	Series 90-30 Axis Positioning Module (Power Mate-APM) Programmer's Manual
GFK-0695	Series 90-30 Enhanced Genius Communications Module User's Manual
GFK-0712	Series 90 Digital Event Recorder User's Manual
GFK-0726	State Logic Processor for Series 90-30 PLC User's Guide
GFK-0771	C Programmer's Toolkit for Series 90 PCMs User's Manual

GFK-0772	PCM C Function Library Reference Manual
GFK-0781	Power Mate APM for Series 90-30 PLC Follower Mode User's Manual
GFK-0814	C Programmer's Toolkit for Series 90 PCM Quick Reference Guide
GFK-0823	Series 90-30 I/O Link Master Module User's Manual
GFK-0828	Series 90-30 Diagnostic System User's Guide
GFK-0840	Power Mate APM for Series 90-30 PLC Standard Mode User's Manual
GFK-0854	Series 90 Sequential Function Chart Programming Language User's Manual
GFK-0898	Series 90-30 PLC I/O Module Specifications Manual
GFK-1028	Series 90-30 I/O Processor Module User's Manual
GFK-1034	Series 90-30 Genius Bus Controller User's Manual
GFK-1037	Series 90-30 FIP Remote I/O Scanner User's Manual
GFK-1056	Series 90-30 State Logic Control System User's Manual
GFK-1084	TCP/IP Ethernet Communications for the Series 90-30 PLC User's Manual
GFK-1179	Installation Requirements for Conformance to Standards
GFK-1186	TCP/IP Ethernet Communications for the Series 90 PLC Station Manager Manual

GFK-1213	Series 90-30 FIP Bus Controller User's Manual
GFK-1256	Power Mate for Series 90-30 User's Manual
GFK-1322	Series 90-30 PLC LonWorks Bus Interface Module User's Manual
GFK-1411	Series 90-30 System Manual for Windows® Users
GFK-1464	Motion Mate DSM302 for Series 90-30 PLCs User's Manual
GFK-1466	Temperature Control Module for the Series 90-30 PLC User's Manual
GFK-1541	TCP/IP Ethernet Communications for the Series 90 PLC User's Manual
GFK-1734	Power Transducer for the Series 90-30 PLC User's Manual
GFK-1868	Machine Edition Getting Started Guide
GFK-2121	Series 90-30 PROFIBUS Modules User's Manual
GFS-062	Series 90-30 Quick Reference Guide for Maintenance
GFZ-0085	Series 90-30 Troubleshooting Pocket Guide
IC690CDU002	InfoLink for PLC CD-ROM



CPU's

For entry-level applications with low I/O counts, the CPU is embedded into the backplane, making all slots available for I/O. These modules are compatible with advanced modules such as Ethernet, various bus modules, and control. Mid-range CPU models are modular and come in various memory sizes, performance capability and increased functionality such as overrides, battery-backed clock and Programmable Coprocessor module support. The high-performance CPUs are based on the latest 386EX processor for fast computation and high throughput. They can handle up to 4,096 I/O and start at 32K of memory and are programmable in a number of standard languages.

	IC693CPU311	IC693CPU313	IC693CPU323	IC693CPU350	IC693CPU360
	5-slot Baseplate (Model 311)	5-slot Baseplate (Model 313)	10-slot Baseplate (Model 323)	CPU (Model 350)	CPU (Model 360)
Product Name					
Lifecycle Status	Mature	Mature	Mature	Mature	Mature
Module Type	I/O Base with built-in CPU	I/O Base with built-in CPU	I/O Base with built-in CPU	CPU Module	CPU Module
Boolean Execution Speed (ms/K)	18	0.6	0.6	0.22	0.22
User Logic Memory (K bytes)	6	12	12	74	240
Real Time Clock	No	No	No	Yes	Yes
I/O Discrete Points	160	160	320	4096	4096
I/O Analog Points	64 In / 32 Out	64 In / 32 Out	64 In / 32 Out	2048 In / 512 Out	2048 In / 512 Out
Type of Memory Storage	RAM, EPROM, EEPROM	RAM, EPROM, EEPROM	RAM, EPROM, EEPROM	RAM, Flash	RAM, Flash
Processor Speed (MHz)	N/A	N/A	N/A	N/A	N/A
	One RS-485 port on power supply. Supports SNP	One RS-485 port on power supply. Supports SNP	One RS-485 port on power supply. Supports SNP	One RS-485 port on power supply. Supports SNP	One RS-485 port on power supply. Supports SNP
Built-in Communication Ports					
Total Number of Racks	1 (CPU built in)	1 (CPU built in)	1 (CPU built in)	8	8
Communications Option Modules	Serial-SNP and RTU, LAN-Genius, Ethernet SRTP and Ethernet Modbus TCP	Serial-SNP and RTU, LAN-Genius, Ethernet SRTP and Ethernet Modbus TCP	Serial-SNP and RTU, LAN-Genius, Ethernet SRTP and Ethernet Modbus TCP	Serial-SNP, SNPX, RTU and CCM, LAN-Genius, Ethernet SRTP and Ethernet Modbus TCP	Serial-SNP, SNPX, RTU and CCM, LAN-Genius, Ethernet SRTP and Ethernet Modbus TCP
Field Busses/Device Networks	Ethernet, Genius, PROFIBUS-DP, DeviceNet, Interbus-S, CsCAN	Ethernet, Genius, PROFIBUS-DP, DeviceNet, Interbus-S, CsCAN	Ethernet, Genius, PROFIBUS-DP, DeviceNet, Interbus-S, CsCAN	Ethernet, Genius, PROFIBUS-DP, DeviceNet, Interbus-S, CsCAN	Ethernet, Genius, PROFIBUS-DP, DeviceNet, Interbus-S, CsCAN
Software Programming Support	Logicmaster (DOS), VersaPro (Windows), Logic Developer -Machine Edition	Logicmaster (DOS), VersaPro (Windows), Logic Developer -Machine Edition	Logicmaster (DOS), VersaPro (Windows), Logic Developer -Machine Edition	Logicmaster (DOS), VersaPro (Windows), Logic Developer -Machine Edition	Logicmaster (DOS), VersaPro (Windows), Logic Developer -Machine Edition
Internal Power Used	410 mA @ 5 VDC	430 mA @ 5 VDC	430 mA @ 5 VDC	670 mA @ 5 VDC	670 mA @ 5 VDC



CPUs

For entry-level applications with low I/O counts, the CPU is embedded into the backplane, making all slots available for I/O. These modules are compatible with advanced modules such as Ethernet, various bus modules, and control. Mid-range CPU models are modular and come in various memory sizes, performance capability and increased functionality such as overrides, battery-backed clock and Programmable Coprocessor module support. The high-performance CPUs are based on the latest 386EX processor for fast computation and high throughput. They can handle up to 4,096 I/O and start at 32K of memory and are programmable in a number of standard languages.

	IC693CPU363	IC693CPU366	IC693CPU367
	CPU (Model 363)	CPU (Model 366 with built-in PROFIBUS Master)	CPU (Model 367 with built-in PROFIBUS Slave)
Product Name			
Lifecycle Status	Mature	Mature	Mature
Module Type	CPU Module	CPU Module	CPU Module
Boolean Execution Speed (ms/K)	0.22	0.22	0.22
User Logic Memory (K bytes)	240	240	240
Real Time Clock	Yes	Yes	Yes
I/O Discrete Points	4096	4096	4096
I/O Analog Points	2048 In / 512 Out	2048 In / 512 Out	2048 In / 512 Out
Type of Memory Storage	RAM, Flash	RAM, Flash	RAM, Flash
Processor Speed (MHz)	N/A	N/A	N/A
Built-in Communication Ports	Three total. One RS-485 port on power supply, one RS-232 and one RS-485 port on CPU. Supports SNP, RTU Master and Slave, Serial Read and Write	One PROFIBUS DP Slave port and RS-485 port on power supply. Supports SNP.	One PROFIBUS DP Master, Class 1 V0 port and RS-485 port on power supply. Supports SNP.
Total Number of Racks	8	8	8
Communications Option Modules	Serial-SNP, SNPX, RTU and CCM, LAN-Genius, Ethernet SRTP and Ethernet Modbus TCP	Serial-SNP, SNPX, RTU and CCM, LAN-Genius, Ethernet SRTP and Ethernet Modbus TCP	Serial-SNP, SNPX, RTU and CCM, LAN-Genius, Ethernet SRTP and Ethernet Modbus TCP
Field Busses/Device Networks	Ethernet, Genius, PROFIBUS-DP, DeviceNet, Interbus-S, CsCAN	Ethernet, Genius, PROFIBUS-DP, DeviceNet, Interbus-S, CsCAN	Ethernet, Genius, PROFIBUS-DP, DeviceNet, Interbus-S, CsCAN
Software Programming Support	Logicmaster (DOS), VersaPro (Windows), Logic Developer - Machine Edition	Logic Developer - Machine Edition	Logic Developer -Machine Edition
Internal Power Used	890 mA @ 5 VDC	940 mA @ 5 VDC	940 mA @ 5 VDC



CPU's

For entry-level applications with low I/O counts, the CPU is embedded into the backplane, making all slots available for I/O. These modules are compatible with advanced modules such as Ethernet, various bus modules, and control. Mid-range CPU models are modular and come in various memory sizes, performance capability and increased functionality such as overrides, battery-backed clock and Programmable Coprocessor module support. The high-performance CPUs are based on the latest 386EX processor for fast computation and high throughput. They can handle up to 4,096 I/O and start at 32K of memory and are programmable in a number of standard languages.

	IC693CPU370	IC693CPU372	IC693CPU374 PLUS
Product Name	CPU (Model 370). Requires High Capacity Power Supply	CPU (Model 372 with built-in 10/100 Mbps Ethernet and WEB Enabled). Requires High Capacity Power Supply	CPU (Model 374 PLUS with built-in 10/100 Mbps Ethernet and Web Enabled). Requires High Capacity Power Supply
Lifecycle Status	Mature	Mature	Mature
Module Type	CPU Module	CPU Module	CPU Module
Boolean Execution Speed (ms/K)	0.15	0.15	0.15
User Logic Memory (K bytes)	240	120	240
Real Time Clock	Yes	Yes	Yes
I/O Discrete Points	4096	4096	4096
I/O Analog Points	2048 In / 512 Out	2048 In / 512 Out	2048 In / 512 Out
Type of Memory Storage	RAM, Flash	RAM, Flash	RAM, Flash
Processor Speed (MHz)	133Mhz	133Mhz	133Mhz
Built-in Communication Ports	One RS-485 port on power supply. Supports SNP	One RS-485 port on power supply. Supports SNP and two Ethernet ports; (one IP address) on CPU, 10/100 Mbps built-in switch, SRTP - channels (Producer and Consumer); EGD, Modbus TCP Client/Server and Web Diagnostics Support	One RS-485 port on power supply. Supports SNP and two Ethernet ports; (one IP address) on CPU, 10/100 Mbps built-in switch, SRTP - channels (Producer and Consumer); EGD, Modbus TCP Client/Server and Web Diagnostics Support
Total Number of Racks	8	8	8
Communications Option Modules	Serial-SNP, SNPX, RTU and CCM, LAN-Genius, Ethernet SRTP and Ethernet Modbus TCP Client/Server	Serial-SNP, SNPX, RTU and CCM, LAN-Genius, Ethernet SRTP and Ethernet Modbus TCP Client/Server	Serial-SNP, SNPX, RTU and CCM, LAN-Genius, Ethernet SRTP and Ethernet Modbus TCP Client/Server
Field Busses/Device Networks	Ethernet, Genius, PROFIBUS-DP, DeviceNet, Interbus-S, CsCAN	Ethernet, Genius, PROFIBUS-DP, DeviceNet, Interbus-S, CsCAN	Ethernet, Genius, PROFIBUS-DP, DeviceNet, Interbus-S, CsCAN
Software Programming Support	Logic Developer - Machine Edition	Logic Developer - Machine Edition	Logic Developer -Machine Edition
Internal Power Used	1.4 Amps @ 5 VDC	1.4 Amps @ 5 VDC	1.4 Amps @ 5 VDC

Baseplates

Series 90-30 baseplates are available in 5- and 10-slot configurations to meet the needs of your application. You can choose expansion or remote baseplates for multi-rack systems, covering distances of up to 700 feet from the CPU. GE offers standard length cables for easy installation and provides wiring information for custom applications.



	IC693CHS391	IC693CHS392	IC693CHS393	IC693CHS397	IC693CHS398	IC693CHS399
Product Name	10-slot CPU Baseplate (Model 331 and above)	10-slot Expansion Baseplate (Model 331 and above)	10-slot Remote Baseplate (Model 331 and above)	5-slot CPU Baseplate (Model 331 and above)	5-slot Expansion Baseplate (Model 331 and above)	5-slot Remote Baseplate (Model 331 and above)
Lifecycle Status	Mature	Mature	Mature	Mature	Mature	Mature
Module Type	CPU I/O Base	Expansion I/O Base	Expansion I/O Base	CPU I/O Base	Expansion I/O Base	Expansion I/O Base
Baseplate Option	Main (With CPU Slot)	Expansion	Expansion	Main (With CPU Slot)	Expansion	Expansion
Distance	N/A	Up to 50 feet	Up to 700 feet	N/A	Up to 50 feet	Up to 700 feet
Number of Slots	10	10	10	5	5	5
Dimension (W x H x D) in. (mm)	17.44 x 5.12 x 5.59 (443 x 130 x 142)	17.44 x 5.12 x 5.59 (443 x 130 x 142)	17.44 x 5.12 x 5.59 (443 x 130 x 142)	10.43 x 5.12 x 5.59 (245 x 130 x 142)	10.43 x 5.12 x 5.59 (245 x 130 x 142)	10.43 x 5.12 x 5.59 (245 x 130 x 142)
Internal Power Used	420 mA @ 5 VDC	150 mA @ 5 VDC	460 mA @ 5 VDC	270 mA @ 5 VDC	170 mA @ 5 VDC	480 mA @ 5 VDC



Power Supplies

The Series 90-30 power supply modules simply snap in just like I/O, and they work with any model CPU. Each version provides auto-ranging so there is no need to set jumpers for different incoming power levels, and they are current limiting so a direct short will shut the power supply down to avoid damage to the hardware. Series 90-30 power supplies are tied into the performance of the CPU for simplex, fail-safe, and fault tolerance. Advanced diagnostics and built-in smart switch fusing are among the other performance and safety features.

	IC693PWR321	IC693PWR330	IC693PWR331	IC693PWR332
Product Name	Power Supply, 120/240 VAC, 125 VDC	Power Supply, 120/240 VAC, 125 VDC	Power Supply, 24 VDC	Power Supply, 12 VDC
Lifecycle Status	Mature	Mature	Mature	Mature
Module Type	Power Supply	Power Supply	Power Supply	Power Supply
Power Source	100-240 VAC or 125 VDC	100-240 VAC or 125 VDC	24 VDC	12 VDC
High Capacity	No	Yes	Yes	Yes
Output Source	30 watts total; 15 watts 5 V; 15 watts 24 V relay; 20 watts 24 V isolated	30 watts total; 30 watts 5 V; 15 watts 24 V relay; 20 watts 24 V isolated	30 watts total; 30 watts 5 V; 15 watts 24 V relay; 20 watts 24 V isolated	30 watts total; 30 watts 5 V; 15 watts 24 V relay; 20 watts 24 V isolated
Number of Redundant Power Supplies Supported	N/A	N/A	N/A	N/A
Cable Length to Redundant Power Supply Adapter	N/A	N/A	N/A	N/A



Power Supplies

The Series 90-30 power supply modules simply snap in just like I/O, and they work with any model CPU. Each version provides auto-ranging so there is no need to set jumpers for different incoming power levels, and they are current limiting so a direct short will shut the power supply down to avoid damage to the hardware. Series 90-30 power supplies are tied into the performance of the CPU for simplex, fail-safe, and fault tolerance. Advanced diagnostics and built-in smart switch fusing are among the other performance and safety features.

IC693PWR328

Product Name	Power Supply, 48 VDC
Lifecycle Status	Mature
Module Type	Power Supply
Power Source	48 VDC
High Capacity	No
Output Source	30 watts total; 15 watts 5 V; 15 watts 24 V relay; 20 watts 24 V isolated
Number of Redundant Power Supplies Supported	N/A
Cable Length to Redundant Power Supply Adapter	N/A



Discrete I/O Modules (Input)

Input modules provide the interface between the PLC and external input devices such as proximity sensors, push buttons, switches, and BCD thumbwheels. Output modules provide the interface between the PLC and external output devices such as contactors, interposing relays, BCD displays and indicator lamps. GE offers a variety of modules that support different voltage ranges and types, current capacity, isolation and response time to meet your application needs.

	IC693ACC300	IC693MDL230	IC693MDL250	IC693MDL231	IC693MDL240
Product Name	DC Voltage Input Simulator, 8/16 Points	AC Voltage Input Module, 120 VAC Isolated, 8 Point Input	AC Voltage Input Module, 120 VAC Isolated, 16 Point Input	AC Voltage Input Module, 240 VAC Isolated, 8 Point Input	AC Voltage Input Module, 120 VAC, 16 Point Input
Lifecycle Status	Mature	Mature	Mature	Mature	Mature
Module Type	Input Simulator	Discrete Input	Discrete Input	Discrete Input	Discrete Input
Power Type	DC	AC	AC	AC	AC
Input Voltage Range	N/A	0-132 VAC	0-132 VAC	0-264 VAC	0-132 VAC
Input Current (mA)	N/A	14.5	14.5	15	12
Number of points	16	8	16	8	16
Response Time (ms)	20 on/30 off	30 on/45 off	30 on/45 off	30 on/45 off	30 on/45 off
Trigger Voltage	N/A	74-132	74-132	148-264	74-132
Points per Common	16	1	1	1	16
Connector Type	Toggle Switches	Terminal Block (20 screws), included with module.	IC694TBBx32 or IC694TBSx32. Sold Separately.	Terminal Block (20 screws), included with module.	Terminal Block (20 screws), included with module.
Internal Power Used	120 mA @ 5 VDC	60 mA @ 5 VDC	60 mA @ 5 VDC	60 mA @ 5 VDC	90 mA @ 5 VDC



Discrete I/O Modules (Input)

Input modules provide the interface between the PLC and external input devices such as proximity sensors, push buttons, switches, and BCD thumbwheels. Output modules provide the interface between the PLC and external output devices such as contactors, interposing relays, BCD displays and indicator lamps. GE offers a variety of modules that support different voltage ranges and types, current capacity, isolation and response time to meet your application needs.

	IC693MDL260	IC693MDL241	IC693MDL632	IC693MDL634	IC693MDL645
Product Name	AC Voltage Input Module, 120 VAC, 32 Point Input	AC/DC Voltage Input Module, 24 VAC/VDC	DC Voltage Input Module, 125 VDC Pos/Neg Logic, 8 Point Input	DC Voltage Input Module, 24 VDC Pos/Neg Logic, 8 Point Input	DC Voltage Input Module, 24 VDC Pos/Neg Logic, 16 Point Input
Lifecycle Status	Mature	Mature	Mature	Mature	Mature
Module Type	Discrete Input	Discrete Input	Discrete Input	Discrete Input	Discrete Input
Power Type	AC	Mixed	DC	DC	DC
Input Voltage Range	0-132 VAC	0-30 VDC	0-150 VDC	0-30 VDC	0-30 VDC
Input Current (mA)	12	7	4.5	7	7
Number of points	32	16	8	8	16
Response Time (ms)	30 on/45 off	12 on/28 off	7 on/7 off	7 on/7 off	7 on/7 off
Trigger Voltage	74-132	11.5-30	90-150	11.5-30	11.5-30
Points per Common	32	16	4	8	16
Connector Type	IC694TBBx32 or IC694TBSx32. Sold Separately.	Terminal Block (20 screws), included with module.	Terminal Block (20 screws), included with module.	Terminal Block (20 screws), included with module.	Terminal Block (20 screws), included with module.
Internal Power Used	90 mA @ 5 VDC	80 mA @ 5 VDC; 125 mA @ 24 VDC Isolated	40 mA @ 5 VDC	45 mA @ 5 VDC; 62 mA @ 24 VDC Isolated	80 mA @ 5 VDC; 125 mA @ 24 VDC Isolated



Discrete I/O Modules (Input)

Input modules provide the interface between the PLC and external input devices such as proximity sensors, push buttons, switches, and BCD thumbwheels. Output modules provide the interface between the PLC and external output devices such as contactors, interposing relays, BCD displays and indicator lamps. GE offers a variety of modules that support different voltage ranges and types, current capacity, isolation and response time to meet your application needs.

	IC693MDL646	IC693MDL648	IC693MDL654	IC693MDL655	IC693MDL660
Product Name	DC Voltage Input Module, 24 VDC Pos/Neg Logic, FAST, 16 Point Input	DC Voltage Input Module, 48 VDC Pos/Neg Logic, FAST, 16 Point Input	DC Voltage Input Module, 5/12 VDC (TTL) Pos/Neg Logic, 32 Point Input	DC Voltage Input Module, 24 VDC Pos/Neg Logic, 32 Point Input	DC Voltage Input Module, 24 VDC Pos/Neg Logic, 32 Point Input
Lifecycle Status	Mature	Mature	Mature	Mature	Mature
Module Type	Discrete Input	Discrete Input	Discrete Input	Discrete Input	Discrete Input
Power Type	DC	DC	DC	DC	DC
Input Voltage Range	0-30 VDC	0-60 VDC	0-15 VDC	0-30 VDC	0-30 VDC
Input Current (mA)	7	4.2	3.0 @ 5 V, 8.5 @ 12 V	7	7
Number of points	16	16	32	32	32
Response Time (ms)	1 on/1 off	1 on/1 off	1 on/1 off	2 on/2 off	0.5ms, 1.0ms, 2.0ms, 5ms, 10ms, 50ms and 100ms, selectable per module. On and off.
Trigger Voltage	11.5-30	34 - 60	4.2-15	11.5-30	11.5-30
Points per Common	16	16	8	8	8
Connector Type	Terminal Block (20 screws), included with module.	Terminal Block (20 screws), included with module.	Fujitsu Connector	Fujitsu Connector	IC694TBBx32 or IC694TBSx32. Sold Separately.
Internal Power Used	80 mA @ 5 VDC; 125 mA @ 24 VDC Isolated	80 mA @ 5 VDC; 125 mA @ 24 VDC Isolated	5 VDC - 195 mA @ 5 VDC; 12 VDC - 440 mA @ 5 VDC	195 mA @ 5 VDC	300 mA @ 5 VDC

Analog I/O Modules (Input)

GE offers easy-to-use analog modules for control processes such as flow, temperature and pressure.



	IC693ALG220	IC693ALG221	IC693ALG222	IC693ALG223
Product Name	Analog Input, Voltage, 4 Channel	Analog Input, Current, 4 Channel	Analog Input, Voltage, High Density (16 Channel)	Analog Input, Current, High Density (16 Channel)
Lifecycle Status	Mature	Mature	Mature	Mature
Module Type	Analog Input	Analog Input	Analog Input	Analog Input
Isolation	1500 volts RMS field to logic side	1500 volts RMS field to logic side	1500 volts RMS field to logic side	1500 volts RMS field to logic side
Range	-10 V to +10 V	4-20 mA, 0-20 mA	-10 V to +10 V, 0 to 10 V	0-20 mA, 4-20 mA
Number of Channels	4	4	16	16
Update Rate	4 ms all channels	2 ms all channels	13 ms all channels	13 ms all channels
Resolution	12 bit; 5 mV/20 μ A/bit	12 bit; 0-20 mA, 5 μ A/bit; 4-20 mA, 4 μ A/bit	12 bit; \pm 10 V, 5 mV/20 μ A/bit; 0-10 V, 5 mV/20 μ A/bit	12 bit; 0-20 mA, 5 μ A/bit; 4-20 mA, 4 μ A/bit; 4-20 mA Enhanced, 5 μ A/bit
Accuracy	\pm 10 mV/40 μ A at 25°C (77°F)	0.1 % full scale	0.25% at 25°C (77°F)	0.25% at 25°C (77°F)
Input Impedance	>9 Megohms	250 ohms	250 ohms	250 ohms
Input Filter Response	17 Hz	325 Hz	200 Hz	200 Hz
Connector Type	Terminal Block (20 screws), included with module.	Terminal Block (20 screws), included with module.	Terminal Block (20 screws), included with module.	Terminal Block (20 screws), included with module.
Internal Power Used	27 mA @ 5 VDC; 98 mA 24 VDC Isolated	25 mA @ 5 VDC; 100 mA @ 24 VDC Isolated	112 mA @ 5 VDC; 4150 mA -User Supplied 24 VDC	120 mA @ 5 VDC; 65 mA-User Supplied 24 VDC



Analog I/O Modules (Input)

GE offers easy-to-use analog modules for control processes such as flow, temperature and pressure.

	HE693ADC410	HE693ADC420
Product Name	Isolated Analog Input Module, Voltage, 1500 VAC, Isolation	Isolated Analog Input Module, Current, 1500 VAC, Isolation
Lifecycle Status	Mature	Mature
Module Type	Analog Input	Analog Input
Range	± 10 V	4-20 mA, ± 20 mA
Number of Channels	4	4
Channel-to-Channel Isolation	1500 VAC (RMS), ± 2000 VDC	1500 VAC (RMS), ± 2000 VDC
Input Impedance	1 Megohm	100 ohms
A/D Type, Resolution	Integrating, 18 bits	Integrating, 18 bits
Useable Resolution	13 bits plus sign	13 bits plus sign
I/O Required	4 %AI, 4 %AQ, 16 %I	8 %AI, 8 %AQ, 16 %I
Sample Rate	45 channels/second	45 channels/second
Analog Filtering	1 KHz, 3 pole Bessel	1 KHz, 3 pole Bessel
Digital Filtering	1-128 samples/update	1-128 samples/update
Maximum Error	.05% full scale	.05% full scale
Common Mode Range	1500 VAC (RMS), ± 2000 VDC	1500 VAC (RMS), ± 2000 VDC
Common Mode Rejection	>100 dB	>100 dB
Power Consumption at Steady State, Maximum	0.7 W @ 5 V, 1.2 W @ 24 V	0.7 W @ 5 V, 1.2 W @ 24 V
Connector Type	Terminal Block (20 screws), included with module.	Terminal Block (20 screws), included with module.
Internal Power Used	140 mA @ 5 VDC ; 50 mA @ 24 VDC Relay	140 mA @ 5 VDC; 50 mA @ 24 VDC Relay

Discrete I/O Modules (Output)



Input modules provide the interface between the PLC and external input devices such as proximity sensors, push buttons, switches, and BCD thumbwheels. Output modules provide the interface between the PLC and external output devices such as contactors, interposing relays, BCD displays and indicator lamps. GE offers a variety of modules that support different voltage ranges and types, current capacity, isolation and response time to meet your application needs.

	IC693MDL330	IC693MDL340	IC693MDL390	IC693MDL350	IC693MDL730
Product Name	AC Voltage Output Module, 120/240 VAC, 1 A, 8 Point Output	AC Voltage Output Module, 120 VAC, 0.5 A, 16 Point Output	AC Voltage Output Module, 120/240 VAC Isolated, 2 A, 5 Point Output	AC Voltage Output Module, 120 VAC Isolated, 2 A, 16 Point Output	DC Voltage Output Module, 12/24 VDC Positive Logic, 2 A, 8 Point Output
Lifecycle Status	Mature	Mature	Mature	Mature	Mature
Power Type	AC	AC	AC	AC	DC
Output Voltage Range	85-264 VAC	85-132 VAC	85-264 VAC	74-264 VAC	12-24 VDC
Number of Points	8	16	5	16	8
Isolation	N/A	N/A	Yes	Yes	N/A
Load Current per Point	1.0 A	0.5 A	2.0 A	Per Point 2A max. @ 30°C & 1A max. @ 60°C (Linear derating)	2.0 A
Response Time (ms)	1 on 1/2 cy off	1 on 1/2 cy off	1 on 1/2 cy off	1 on 1/2 cy off	2 on/2 off
Output Type	Triac	Triac	Triac	Triac	Transistor
Polarity	N/A	N/A	N/A	N/A	Positive
Points per Common	4	4	1	1	8
Connector Type	Terminal Block (20 screws), included with module.	Terminal Block (20 screws), included with module.	Terminal Block (20 screws), included with module.	IC694TBBx32 or IC694TBSx32. Sold Separately.	Terminal Block (20 screws), included with module.
Internal Power Used	160 mA @ 5 VDC	315 mA @ 5 VDC	110 mA @ 5 VDC	110 mA @ 5 VDC	55 mA @ 5 VDC



Discrete I/O Modules (Output)

Input modules provide the interface between the PLC and external input devices such as proximity sensors, push buttons, switches, and BCD thumbwheels. Output modules provide the interface between the PLC and external output devices such as contactors, interposing relays, BCD displays and indicator lamps. GE offers a variety of modules that support different voltage ranges and types, current capacity, isolation and response time to meet your application needs.

	IC693MDL731	IC693MDL732	IC693MDL733	IC693MDL734	IC693MDL740	IC693MDL741
Product Name	DC Voltage Output Module, 12/24 VDC Negative Logic, 2 A, 8 Point Output	DC Voltage Output Module, 12/24 VDC Positive Logic, 0.5 A, 8 Point Output	DC Voltage Output Module, 12/24 VDC Negative Logic, 0.5 A, 8 Point Output	DC Voltage Output Module, 125 VDC Pos/Neg Logic, 6 Point Output	DC Voltage Output Module, 12/24 VDC Positive Logic, 0.5 A, 16 Point Output	DC Voltage Output Module, 12/24 VDC Negative Logic, 0.5 A, 16 Point Output
Lifecycle Status	Mature	Mature	Mature	Mature	Mature	Mature
Power Type	DC	DC	DC	DC	DC	DC
Output Voltage Range	12-24 VDC	12-24 VDC	12-24 VDC	11-150 VDC	12-24 VDC	12-24 VDC
Number of Points	8	8	8	6	16	16
Isolation	N/A	N/A	N/A	N/A	N/A	N/A
Load Current per Point	2.0 A	0.5 A	0.5 A	1.0 A	0.5 A	0.5 A
Response Time (ms)	2 on/2 off	2 on/2 off	2 on/2 off	7 on/5 off	2 on/2 off	2 on/2 off
Output Type	Transistor	Transistor	Transistor	Transistor	Transistor	Transistor
Polarity	Negative	Positive	Negative	Positive/Negative	Positive	Negative
Points per Common	8	8	8	1	8	8
Connector Type	Terminal Block (20 screws), included with module.	Terminal Block (20 screws), included with module.	Terminal Block (20 screws), included with module.	Terminal Block (20 screws), included with module.	Terminal Block (20 screws), included with module.	Terminal Block (20 screws), included with module.
Internal Power Used	55 mA @ 5 VDC	50 mA @ 5 VDC	55 mA @ 5 VDC	90 mA @ 5 VDC	110 mA @ 5 VDC	110 mA @ 5 VDC



Discrete I/O Modules (Output)

Input modules provide the interface between the PLC and external input devices such as proximity sensors, push buttons, switches, and BCD thumbwheels. Output modules provide the interface between the PLC and external output devices such as contactors, interposing relays, BCD displays and indicator lamps. GE offers a variety of modules that support different voltage ranges and types, current capacity, isolation and response time to meet your application needs.

	IC693MDL742	IC693MDL748	IC693MDL752	IC693MDL758	IC693MDL753	IC693MDL754
Product Name	DC Voltage Output Module, 12/24 VDC Positive Logic ESCP, 1 A, 16 Point Output	DC Voltage Output Module, 48/24 VDC Positive Logic, 0.5 A, 8 Point Output	DC Voltage Output Module, 5/24 VDC (TTL) Negative Logic, 0.5 A, 32 Point Output	DC Voltage Output Module, 12/24 VDC Positive Logic with ESCP (Self Healing) per group, 0.5 A, 32 Point Output (Two groups of 16)	DC Voltage Output Module, 12/24 VDC Positive Logic, 0.5 A, 32 Point Output	DC Voltage Output Module, 12/24 VDC Positive Logic, 0.75 A, with ESCP protection, 32 Point Output
Lifecycle Status	Mature	Mature	Mature	Mature	Mature	Mature
Power Type	DC	DC	DC	DC	DC	DC
Output Voltage Range	12-24 VDC	24-48 VDC	5, 12-24 VDC	12-24 VDC	12-24 VDC	12-24 VDC
Number of Points	16	8	32	32	32	32
Isolation	N/A	N/A	N/A	N/A	N/A	N/A
Load Current per Point	1.0 A	0.5 A	0.5 A	0.5 A	0.5 A	0.75 A with ESCP protection
Response Time (ms)	2 on/2 off	2 on/2 off	0.5 on/0.5 off	0.5 on/0.5 off	0.5 on/0.5 off	0.5 on/0.5 off
Output Type	Transistor	Transistor	Transistor	Transistor	Transistor	Transistor
Polarity	Positive	Positive	Negative	Positive	Positive	Positive
Points per Common	8	8	8	16	8	16
Connector Type	Terminal Block (20 screws), included with module.	Terminal Block (20 screws), included with module.	Fujitsu Connector	IC694TBBx32 or IC694TBSx32. Sold Separately.	Fujitsu Connector	IC694TBBx32 or IC694TBSx32. Sold Separately.
Internal Power Used	130 mA @ 5 VDC	110 mA @ 5 VDC	260 mA @ 5 VDC	250 mA @ 5 VDC	260 mA @ 5 VDC	300 mA @ 5 VDC



Discrete I/O Modules (Output)

Input modules provide the interface between the PLC and external input devices such as proximity sensors, push buttons, switches, and BCD thumbwheels. Output modules provide the interface between the PLC and external output devices such as contactors, interposing relays, BCD displays and indicator lamps. GE offers a variety of modules that support different voltage ranges and types, current capacity, isolation and response time to meet your application needs.

	IC693MDL930	IC693MDL916	IC693MDL931	IC693MDL940	IC693MAR590
Product Name	AC/DC Voltage Output Module, Relay, N.O., 4 A Isolated, 8 Point Output	AC/DC Voltage Output Module, Relay, N.O., 4 A Isolated, 16 Point Output	AC/DC Voltage Output Module, Relay, N.C. and Form C, 8 A Isolated, 8 Point Out	AC/DC Voltage Output Module, Relay, N.O., 2 A, 16 Point Output	AC/DC Voltage I/O Module, AC In/Relay Out N.O.
Lifecycle Status	Mature	Mature	Mature	Mature	Mature
Power Type	Mixed	Mixed	Mixed	Mixed	Mixed
Output Voltage Range	0 to 125 VDC, 5/24/125 VDC nominal 0 to 265 VAC (47 to 63 Hz), 120/240 VAC nominal	5 – 125 VDC, 5/24/125 VDC nominal 5 – 250 VAC (47 to 63 Hz), 120-240 VAC nominal	0 to 125 VDC, 5/24/125 VDC nominal 0 to 265 VAC (47 to 63 Hz), 120/240 VAC nominal	0 to 125 VDC, 5/24/125 VDC nominal 0 to 265 VAC (47 to 63 Hz), 120/240 VAC nominal	5-250 VAC/5-30 VDC
Number of Points	8	16	8	16	8
Isolation	Yes	Yes	Yes	N/A	N/A
Load Current per Point	4.0 A	4.0 A	8.0 A	2.0 A	2.0 A
Response Time (ms)	15 on/15 off	10ms maximum (At nominal voltage excluding contact bounce)	15 on/15 off	15 on/15 off	30 on/45 off
Output Type	Relay	Relay	Relay	Relay	Relay
Polarity	N/A	N/A	N/A	N/A	N/A
Points per Common	1	1	1	4	8
Connector Type	Terminal Block (20 screws), included with module.	IC694TBBx32 or IC694TBSx32. Sold Separately.	Terminal Block (20 screws), included with module.	Terminal Block (20 screws), included with module.	Terminal Block (20 screws), included with module.
Internal Power Used	6 mA @ 5 VDC; 70 mA @ 24 VDC Relay	300 mA @ 5 VDC from backplane maximum	6 mA @ 5 VDC; 110 mA @ 24 VDC Relay	7 mA @ 5 VDC; 135 mA @ 24 VDC Relay	80 mA @ 5 VDC; 70 mA @ 24 VDC Relay



Discrete I/O Modules (Output)

Input modules provide the interface between the PLC and external input devices such as proximity sensors, push buttons, switches, and BCD thumbwheels. Output modules provide the interface between the PLC and external output devices such as contactors, interposing relays, BCD displays and indicator lamps. GE offers a variety of modules that support different voltage ranges and types, current capacity, isolation and response time to meet your application needs.

	IC693MDR390	HE693RLY100	HE693RLY110
Product Name	AC/DC Voltage Output Module, 24 VDC Input, Relay Output, 8 In/8 Out	DC Voltage Output Module, AC In/Relay Out (isolated)	DC Voltage Output Module, AC In/Relay Out (fused)
Lifecycle Status	Mature	Mature	Mature
Power Type	Mixed	Mixed	Mixed
Output Voltage Range	0 to 125 VDC, 5/24/125 VDC nominal 0 to 265 VAC (47 to 63 Hz), 120/240 VAC nominal	12-120 VAC, 12-30 VDC	12-120 VAC, 12-30 VDC
Number of Points	8	8	8
Isolation	N/A	Yes	No
Load Current per Point	2.0 A	8.0 A	8.0 A
Response Time (ms)	1 on/1 off	11 on/11 off	11 on/11 off
Output Type	Relay	Relay	Relay
Polarity	N/A	N/A	N/A
Points per Common	8	1	1
Connector Type	Terminal Block (20 screws), included with module.	Terminal Block (20 screws), included with module.	Terminal Block (20 screws), included with module.
Internal Power Used	80 mA @ 5 VDC; 70 mA @ 24 VDC Relay	180 mA @ 5 VDC; 200 mA @ 24 VDC Relay	180 mA @ 5 VDC; 200 mA @ 24 VDC Relay



Analog I/O Modules (Output)

GE offers easy-to-use analog modules for control processes such as flow, temperature and pressure.

	IC693ALG390	IC693ALG391	IC693ALG392	IC693ALG442
Product Name	Analog Output, Voltage, 2 Channel	Analog Output, Current/Voltage, 2 Channel	Analog Current/Voltage Output, 8 Channel	Analog Current/Voltage Combination 4 Channel In/2 Channel Out
Lifecycle Status	Mature	Mature	Mature	Mature
Module Type	Analog Output	Analog Output	Analog Output	Analog Input/Output
Isolation	1500 volts RMS field to logic side	1500 volts RMS field to logic side	1500 volts RMS field to logic side	1500 volts RMS field to logic side
Range	-10 V to +10 V, 4-20 mA	1-5 V and 0-5 V, 0-20 mA, 4-20 mA	0 V to +10 V, -10 V to +10 V, 0-20 mA, 4-20 mA	0 V to +10 V, -10 V to +10 V, 0-20 mA, 4-20 mA
Number of Channels	2	2	8	4 in/2 out
Channel-to-Channel Isolation	N/A	N/A	N/A	N/A
Diagnostics	N/A	N/A	Open Wire	N/A
Update Rate	5 ms all channels	5 ms all channels	8 ms all channels	8 ms all channels In / 4 ms all channels Out
Resolution	12 bit; 2.5 mV/bit	12 bit; 0-20 mA, 5µA/bit	16 bit; 0.312 mV/bit	(Input)12 bit; 0 V to 10 V, 2.5 mV/bit; -10 V to +10 V, 5 mV/bit; 0-20 mA, 4-20 mA 5µA/bit (Output) 16 bit; 0.312 mV/bit; 4-20 mA 0.5 µA/bit; 0-20 mA 0.625 µA/bit
Accuracy	±5 mV at 25°C (77°F)	0-20 mA, ±8 µA at 25°C (77°F); 0-20 mA, 4-20 mA ±0.1% at 25°C (77°F)	0-20 mA, 4-20 mA ±0.1% at 25°C (77°F); 0-10 V, -10F + 10 V ±0.25 at 25°C (77°F)	(Input) 0.25 % at 25°C (77°F) (Output) 0-20 mA, 4-20 mA ±0.1% at 25°C (77°F)
Maximum Output Load	5 mA (2 K ohms)	5 mA (2 K ohms)	5 mA (2 K ohms)	5 mA (2 K ohms); 850 ohms
Output Load Capacitance	2000 pF	2000 pF, Inductance 1H	2000 pF, Inductance 1H	2000 pF, Inductance 1H
Power Consumption at Steady State, Maximum	N/A	N/A	N/A	N/A
User Supplied Loop Voltage	N/A	N/A	N/A	N/A
Maximum Load (ohms)	N/A	N/A	N/A	N/A
Maximum Linearity Error	N/A	N/A	N/A	N/A
Common Mode Isolation	N/A	N/A	N/A	N/A
Connector Type	Terminal Block (20 screws), included with module.	Terminal Block (20 screws), included with module.	Terminal Block (20 screws), included with module.	Terminal Block (20 screws), included with module.
Internal Power Used	32 mA @ 5 VDC; 120 mA @ 24 VDC Isolated	30 mA @ 5 VDC; 215 mA 24 VDC Isolated	110 mA @ 5 VDC; 315 mA -User Supplied 24 VDC	95 mA @ 5 VDC; 129 mA 24 VDC Isolated



Analog I/O Modules (Output)

GE offers easy-to-use analog modules for control processes such as flow, temperature and pressure.

	HE693DAC410	HE693DAC420
Product Name	Isolated Analog Output Module, Voltage	Isolated Analog Output Module, Current
Lifecycle Status	Mature	Mature
Module Type	Analog Output	Analog Output
Isolation	N/A	N/A
Range	±10 V	4-20 mA or 0-20 mA
Number of Channels	4	4
Channel-to-Channel Isolation	1500 VAC (RMS),±2000 VDC	1500 VAC (RMS),±2000 VDC
Diagnostics	N/A	N/A
Update Rate	N/A	N/A
Resolution	13 bits plus sign, 1.2 5mV	13 bits plus sign, 2.0 µA (4-20 mA); 2.5 µA (±20 mA)
Accuracy	N/A	N/A
Maximum Output Load	N/A	N/A
Output Load Capacitance	N/A	N/A
Power Consumption at Steady State, Maximum	0.75 W @ 5 V; 3.6 W @ 24 V	0.75 W @ 5 V; 3.6 W @ 24 V
User Supplied Loop Voltage	N/A	2-32 VDC
Maximum Load (ohms)	>= 2 Kohms	</= 1.1 Kohms @ 24 V loop voltage
Maximum Linearity Error	0.02% full scale	0.02% full scale
Common Mode Isolation	1500 VAC (RMS),±2000 VDC	1500 VAC (RMS), ±2000 VDC
Connector Type	Terminal Block (20 screws), included with module.	Terminal Block (20 screws), included with module.
Internal Power Used	500 mA @ 5 VDC; 150 mA @ 24 VDC Relay	150 mA @ 5 VDC; 110 mA @ 24 VDC Relay



Millivolt I/O Modules

The Millivolt Input Modules allow millivolt level signals, such as bridged strain gages (load cells) to be directly connected to the PLC without external signal processing (transducers, transmitters, etc.) All analog and digital processing of the signal is performed on the module.

HE693ADC409

Product Name	Analog I/O Module, Millivolt Input
Lifecycle Status	Mature
Module Type	Millivolt Input
Input Voltage Range	± 25 mV, ± 50 mV and ± 100 mV
Number of Channels	4
Resolution	3 μ V, 6 μ V, 9 μ V (respectively)
Accuracy	$\pm 0.5\%$
Input Impedance	>20 Mohms
A/D Conversion Type	Integrating
A/D Conversion Time	35 Channels/second
Strain Gages Supported	Bridged (load cells)
Maximum Normal Voltage Input	100 mV
Maximum Voltage Input	± 35 V
Connector Type	Terminal Block (20 screws), included with module.
Internal Power Used	100 mA @ 5 VDC



RTD I/O Modules

The RTD Input Modules provide six RTD inputs that allow the direct connection of 3-wire RTD temperature sensors without using external signal processing (transducers, transmitters, etc.). All analog and digital processing of the RTD signal is performed on the module.

	HE693RTD600	HE693RTD601	HE693RTD660
Product Name	RTD Input Module, Low Resolution	RTD Input Module, High Resolution	RTD Input Module, Isolated
Lifecycle Status	Mature	Mature	Mature
Module Type	RTD Input	RTD Input	RTD Input
Number of Channels	6	6	6
RTD Types Supported	3-wire, Pt-100E, Pt-100C, Pt-100Z, Pt-1000, Cu-10, Cu-50, PT-100, Cu-53, Cu-100, Ni-120, TD5R, TD5R, Pt-90 (MIL-7990)	3-wire, Pt-100E, Pt-100C, Pt-100Z, Pt-1000, Cu-10, Cu-50, PT-100, Cu-53, Cu-100, Ni-120, TD5R, TD5R, Pt-90 (MIL-7990)	3 wire, Pt-100E, Pt-100C, Ni-120, Cu-10, Pt-1000, TD5R Si
Channel-to-Channel Isolation	N/A	N/A	5 VAC
Notch Filter	N/A	N/A	None
Resolution	0.5°C or 0.5°F	0.125°C, 0.1°C, or 0.1°F	0.05°C, 0.05°F, 0.1°C, 0.1°F, 0.5°C or 0.5°F
Accuracy	±0.5°C, typical	±0.5°C, typical	±0.3°C
Input Impedance	>1000 Megohms	>1000 Megohms	>1000 Megohms
Fault Protection	Zener Diode Clamp	Zener Diode Clamp	Suppression Diode
Update Time	50 Channels/second	50 Channels/second	50 Channels/second
A/D Conversion Type	18 bit, integrating	18 bit, integrating	18 bit, integrating
Average RTD Current, Pt-100	330 microamps	330 microamps	330 microamps
Channel-to-Channel Tracking	0.1°C	0.1°C	0.1°C
Channel-to-Bus Isolation	N/A	N/A	1500 VAC
RTD Short	N/A	N/A	Indefinite without damage
Connector Type	Terminal Block (20 screws), included with module.	Terminal Block (20 screws), included with module.	Terminal Block (20 screws), included with module.
Internal Power Used	70 mA @ 5 VDC	70 mA @ 5 VDC	200 mA @ 5 VDC



Strain Gage I/O Modules

The Millivolt Input Modules allow millivolt level signals, such as bridged strain gages (load cells) to be directly connected to the PLC without external signal processing (transducers, transmitters, etc.) All analog and digital processing of the signal is performed on the module.

	HE693STG883	HE693STG884
Product Name	Analog I/O Module, Strain Gage	Analog I/O Module, Strain Gage
Lifecycle Status	Mature	Mature
Module Type	Strain Gage Input	Strain Gage Input
Input Voltage Range	±20 mV, ±25 mV and ±30mV	±25 mV, ±50 mV and ±100mV
Number of Channels	8	8
Resolution	0.6 μV, 0.8 μV, 0.9 μV (respectively)	0.8 μV, 1.6 μV, 3.2 μV (respectively)
Accuracy	±0.3%	±0.3 %
Input Impedance	>1000 Mohms	>1000 Mohms
A/D Conversion Type	Integrating	Integrating
A/D Conversion Time	35 Channels/second	35 Channels/second
Strain Gages Supported	Bridged (load cells)	Bridged (load cells)
Maximum Normal Voltage Input	100 mV	100 mV
Maximum Voltage Input	±35 V	±35 V
Connector Type	Terminal Block (20 screws), included with module.	Terminal Block (20 screws), included with module.
Internal Power Used	60 mA @ 5 VDC; 30 mA @ 24 VDC Relay	60 mA @ 5 VDC; 30 mA @ 24 VDC Relay



Temperature Control Modules

The Temperature Control Module (TCM), is a high performance control module providing eight channels of thermocouple input and eight channels of control output in a single Series 90-30 module. Each channel can operate in closed or open loop mode relieving the PLC of providing the temperature control functions. The module also supports Autotuning.

	IC693TCM302	IC693TCM303
Product Name	Temperature Control Module, (8) T/C, (1) RTD and (8) 24 VDC Output	Temperature Control Module, Extended Range, 8 T/C, 1RTD and 8 24 VDC Output
Lifecycle Status	Mature	Mature
Module Type	Thermocouple Input	Thermocouple Input
Thermocouples	8 channels (Type J, K or L); J=0-450°C; K=0-600°C; L=0-450°C; 1 internal/external compensation channel, 12-bits or 0.2°C resolution, 100 ms/ channel update, ±1°C accuracy with automatic calibration	8 channels (Type J, K or L); J=0-600°C; K=0-1050°C; L=0-600°C; 1 internal/external compensation channel, 12-bits or 0.2°C resolution, 100 ms/ channel update, ±1°C accuracy with automatic calibration
RTD Input	1 channel with Open/Short Circuit Detection; Type: Pt-100 ($\mu=0.00392$) for temperature compensation	1 channel with Open/Short Circuit Detection; Type: Pt-100 ($\mu=0.00392$) for temperature compensation
Temperature Range	J=0-600°C, K=0-1050°C, L=0-600°C	J=0-450°C, K=0-600°C, L=0-450°C
Output Voltage Range	18 to 30 volts DC	18 to 30 volts DC
Load Current per point	100 mA maximum sourcing	100 mA maximum sourcing
Number of Channels	8 T/C In / 8 DC Out	8 T/C In / 8 DC Out
Diagnostics	Open thermocouple and reverse connection detection capability; Detection and indication of out-of-tolerance temperature readings	Open thermocouple and reverse connection detection capability; Detection and indication of out-of-tolerance temperature readings
Connector Type	Two 20 pin connectors (screw type)	Two 20 pin connectors (screw type)
Internal Power Used	150 mA @ 5 VDC	150 mA @ 5 VDC

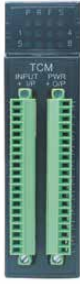

Thermocouple I/O Modules

The Thermocouple Input Modules allow thermocouple temperature sensors to be directly connected to the PLC with external signal processing (transducers, transmitters, etc.). The module performs all analog and digital processing of the thermocouple signal. The enhanced thermocouple input modules add isolation or high-resolution. On these modules, each channel can be configured for a specific type of sensor wire. An autodetect external AD592 cold junction compensation feature is also available.

	HE693THM166	HE693THM409	HE693THM449
Product Name	Analog I/O Thermocouple Input Module	Analog I/O Thermocouple Input Module	Analog I/O Thermocouple Input Module
Lifecycle Status	Mature	Mature	Mature
Module Type	Thermocouple Input	Thermocouple Input	Thermocouple Input
Range	J, K, N, T, E, R, S, B, C, X	J, K, N, T, E, R, S	J, K, N, T, E, R, S
Number of Channels	16	4	4
Channel-to-Channel Isolation	N/A	N/A	N/A
Notch Filter	N/A	N/A	N/A
Open Circuit Alarm	Yes	No	Yes
Resolution	0.5°C or 0.5°F	0.5°C or 0.5°F	0.5°C or 0.5°F
Accuracy	±0.5°C, typical (J,K,N,T)	±0.5°C, typical (J,K,N,T)	±0.5°C, typical (J,K,N,T)
A/D Conversion Type	Integrating	Integrating	Integrating
A/D Conversion Time	40 Channels/second	40 Channels/second	40 Channels/second
Open Circuit Detection	Yes	Yes	Yes
Setpoint Alarm	N/A	N/A	N/A
Diagnostics	Open Circuit Detection	Open Circuit Detection	Open Circuit Detection
Connector Type	Terminal Block (20 screws), included with module.	Terminal Block (20 screws), included with module.	Terminal Block (20 screws), included with module.
Internal Power Used	80 mA @ 5 VDC; 30 mA @ 24 VDC Relay	80 mA @ 5 VDC; 60 mA @ 24 VDC Relay	80 mA @ 5 VDC; 60 mA @ 24 VDC Relay

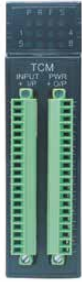

Thermocouple I/O Modules

The Thermocouple Input Modules allow thermocouple temperature sensors to be directly connected to the PLC with external signal processing (transducers, transmitters, etc.). The module performs all analog and digital processing of the thermocouple signal. The enhanced thermocouple input modules add isolation or high-resolution. On these modules, each channel can be configured for a specific type of sensor wire. An autodetect external AD592 cold junction compensation feature is also available.

	HE693THM809	HE693THM884	HE693THM888	HE693THM889
Product Name	Analog I/O Thermocouple Input Module	Analog I/O Thermocouple Input Module (Enhanced)	Analog I/O Thermocouple Input Module (Enhanced)	Analog I/O Thermocouple Input Module
Lifecycle Status	Mature	Mature	Mature	Mature
Module Type	Thermocouple Input	Thermocouple Input	Thermocouple Input	Thermocouple Input
Range	J, K, N, T, E, R, S	J, K, N, T, E, R, S, B, C	J, K, N, T, E, R, S, B, C	J, K, N, T, E, R, S
Number of Channels	8	8	8	8
Channel-to-Channel Isolation	N/A	N/A	N/A	N/A
Notch Filter	N/A	None	60 Hz	N/A
Open Circuit Alarm	No	Yes	Yes	Yes
Resolution	0.5°C or 0.5°F	N/A	N/A	0.5°C or 0.5°F
Accuracy	±0.5°C, typical (J,K,N,T)	N/A	N/A	±0.5°C, typical (J,K,N,T)
A/D Conversion Type	Integrating	N/A	N/A	Integrating
A/D Conversion Time	40 Channels/second	N/A	N/A	40 Channels/second
Open Circuit Detection	Yes	Yes	Yes	Yes
Setpoint Alarm	N/A	Yes	Yes	N/A
Diagnostics	Open Circuit Detection	Open Circuit Detection and Alarms	Open Circuit Detection and Alarms	Open Circuit Detection
Connector Type	Terminal Block (20 screws), included with module.	Terminal Block (20 screws), included with module.	Terminal Block (20 screws), included with module.	Terminal Block (20 screws), included with module.
Internal Power Used	80 mA @ 5 VDC; 60 mA @ 24 VDC Relay	100 mA @ 5 VDC; 60 mA @ 24 VDC Relay	100 mA @ 5 VDC; 60 mA @ 24 VDC Relay	80 mA @ 5 VDC; 60 mA @ 24 VDC Relay



Networks and Distributed I/O Systems

The Series 90-30 features a variety of communications options for distributed control and/or I/O. Choose from Ethernet EGD, PROFIBUS-DP, Genius, DeviceNet, Interbus-S, Series 90 Protocol (SNP) and RTU modules. These communication modules are easy to install and quick to configure.

	IC693PBM200	IC693PBS201	IC693BEM331
Product Name	Communications Module, PROFIBUS-DP Module (Master)	Communications Module, PROFIBUS-DP Module (Slave)	Series 90-30 I/O Bus Module, Genius Bus Controller
Lifecycle Status	Mature	Mature	Mature
Module Type	PROFIBUS-DP Master	PROFIBUS-DP Slave	Genius Bus Controller
Protocol Support	PROFIBUS DP	PROFIBUS DP	Genius
Entity Type	Master	Slave	Master
Bus Speed	12Mbaud	12Mbaud	153.6Kbaud
Network Distance	Baud Rate Dependent. Supports all standard data rates (9.6 kBit/s, 19.2 kBit/s, 93.75 kBit/s, 187.5 kBit/s, 500 kBit/s, 1.5 MBit/s, 3 MBit/s, 6 MBit/s and 12 MBit/s)	Baud Rate Dependent. Supports all standard data rates (9.6 kBit/s, 19.2 kBit/s, 93.75 kBit/s, 187.5 kBit/s, 500 kBit/s, 1.5 MBit/s, 3 MBit/s, 6 MBit/s and 12 MBit/s)	7500 feet (2286 meters) at 38.4 Kbaud; 4500 feet (1371 meters) at 76.8 Kbaud; 3500 feet (1066 meters) at 153.6 Kbaud extended; 2000 feet (609 meters) at 153.6 Kbaud standard. Maximum length at each baud rate also depends on cable type.
Bus Diagnostics	Supported	Supported	Supported
Number of Drops Supported	125 Slaves	One	32
Message Size	244 bytes of input and 244 bytes of output for each slave. Not to exceed 3584 bytes input and 3584 bytes outputs total for the system.	244 bytes of input and 244 bytes of output	255 bytes
Internal Power Used	450 @ 5 VDC	450 @ 5 VDC	300 mA @ 5 VDC



Networks and Distributed I/O Systems

The Series 90-30 features a variety of communications options for distributed control and/or I/O. Choose from Ethernet EGD, PROFIBUS-DP, Genius, DeviceNet, Interbus-S, Series 90 Protocol (SNP) and RTU modules. These communication modules are easy to install and quick to configure.

	IC693DNM200	IC693DNS201	IC693CMM302
Product Name	Series 90-30 Communications Module, DeviceNet, Master	Series 90-30 Communications Module, DeviceNet, Slave	Series 90-30 Enhanced Genius Communications Module
Lifecycle Status	Mature	Mature	Mature
Module Type	DeviceNet Master	DeviceNet Slave	Genius Peer to Peer
Protocol Support	DeviceNet	DeviceNet	N/A
Entity Type	Master	Slave	Peer-to-Peer
Bus Speed	500Kbaud	500Kbaud	153.6Kbaud
Network Distance	500Kbaud 100 meters to 125Kbaud 500 meters. Maximum length at each baud rate also depends on cable type.	500Kbaud 100 meters to 125Kbaud 500 meters. Maximum length at each baud rate also depends on cable type.	7500 feet (2286 meters) at 38.4 Kbaud; 4500 feet (1371 meters) at 76.8 Kbaud; 3500 feet (1066 meters) at 153.6 Kbaud extended; 2000 feet (609 meters) at 153.6 Kbaud standard. Maximum length at each baud rate also depends on cable type.
Bus Diagnostics	Supported	Supported	N/A
Number of Drops Supported	64	N/A	N/A
Message Size	3972 bytes Input and 3972 bytes Output	255 bytes In and 255 bytes Out	N/A
Internal Power Used	450 @ 5 VDC	450 @ 5 VDC	300 mA @ 5 VDC



Networks and Distributed I/O Systems

The Series 90-30 features a variety of communications options for distributed control and/or I/O. Choose from Ethernet EGD, PROFIBUS-DP, Genius, DeviceNet, Interbus-S, Series 90 Protocol (SNP) and RTU modules. These communication modules are easy to install and quick to configure.

IC693BEM320

IC693BEM321

Product Name	Series 90-30 Communication, I/O Link Interface Module (Slave)	Series 90-30 Communication, I/O Link Interface Module (Master)
Lifecycle Status	Mature	Mature
Module Type	I/O Link	I/O Link
Protocol Support	N/A	N/A
Entity Type	Slave	Master
Bus Speed	1.5 mHz	1.5 mHz
Network Distance	10 meters (33 feet) RS-485; 200 meters (660 feet)	10 meters (33 feet) RS-485; 200 meters (660 feet)
Bus Diagnostics	N/A	N/A
Number of Drops Supported	N/A	N/A
Message Size	N/A	N/A
Internal Power Used	205 mA @ 5 VDC	415 mA @ 5 VDC



Serial Communications Modules

The Series 90-30 features a variety of communications options for distributed control and/or I/O. Choose from Ethernet EGD, PROFIBUS-DP, Genius, DeviceNet, Interbus-S, Series 90 Protocol (SNP) and RTU modules. These communication modules are easy to install and quick to configure.

HE693SNP900

Product Name	Communications Module, SNP Slave Module from Horner Electric
Lifecycle Status	Mature
Module Type	SNP Module
Protocol Support	SNP Slave
Communication Ports	RS-232, RS-232/485
Backplane Compatibility	No Restrictions
Internal Power Used	250 mA @ 5 VDC



Power Measurement Modules

The Power Transducer Module (PTM) and Power Synchronization and Measurement (PSM) module measure and calculate critical data for control of electrical power systems and synchronization of power grids. Both the PTM and PSM connect to user supplied current and potential transformers, which translate power grid signals to proportionate, low-level signals for measurement and analysis. The PTM module is not intended to provide a protective relay function or be used for energy billing purposes. The PSM module provides ANSI protective relay calculations and revenue grade monitoring for a complete genset, paralleling switchgear or infrastructure management solution. Both the PTM and PSM consist of a processing module that plugs into the PLC backplane, an interface module for field wiring connections, and cables to interconnect the two modules. The PTM and PSM can be used with Wye or Delta type three-phase power or with single-phase power systems.

IC693PTM101

Product Name	Power Transducer Module Processing Module interface board (a panel mounted circuit board). This board interfaces between the Power Transducer module and the input transformers (current and potential), 1.0 meter Interface cable that connects the module to the Interface board.	
Lifecycle Status	Mature	
Module Type	Power Transducer Modules	
Input Voltage Range	10-120 VAC (nominal)	
Power Measurement Configurations	Grids	Circuits
	1	0
	0	up to 4
Current Input Range	0 to 7.5 Amps RMS (5 A RMS nominal)	
Frequency Range	35 Hz to 70 Hz	
Output Rating	N/A	
Number of Outputs	0	
Data	<p>Data availability</p> <ul style="list-style-type: none"> • Data calculation rate: 20ms @ 50 Hz, 16.67ms @ 60 Hz • Data latency: 15ms @ 50 Hz, 16.67ms @ 60 Hz <p>Measured Data</p> <ul style="list-style-type: none"> • RMS voltage of phase A, B, and C (in Volts x 10) • RMS currents of phase A, B, C, and Neutral (in Amperes x 1000) for each grid • DC component of measured RMS voltages (in Volts x 10) • Frequency of phase A grid 1 (in Hz x 100) • Phase angle between phase A grid 1 and phase A grid 2 (in degrees x 10) <p>Power and Energy Data</p> <ul style="list-style-type: none"> • Active and reactive power reported per phase and total in Watts, Volt-Amperes-Reactive (VAR) • Active and reactive total energy consumption in Watt-Seconds and Volt-Amperes-Reactive-Seconds (updated once per second), re-settable by the user • Total power factor • Average real and reactive power consumption (sliding 15 minute window updated once per second) 	
Status and Diagnostics	<ul style="list-style-type: none"> • Module Heartbeat (indicates module health) • Utility Phase A voltage present • Phase polarity valid • Voltage measurements valid • Current measurements valid 	
Internal Power Used	400 mA @ 5 VDC	



Pneumatic Module

This IC693MDL760 output module provides eleven pneumatic outputs and five 24 VDC sourcing outputs. For each pneumatic output, the module contains an internal 3-way solenoid-actuated valve and an associated output fitting, which is located on the front panel. When an output is turned ON, its internal valve connects a user supplied pressure source (100 psi maximum) to the output fitting. The pressure source is connected to the fitting on the bottom of the module. When the output is turned OFF, the valve's output port is vented to atmosphere inside the module. Solenoid power is supplied from an external 24 VDC source to the "DC Outputs" connector on the front panel.

IC693MDL760

Product Name	Series 90-30 Solenoid Module
Lifecycle Status	Mature
Number of Points	(11) Pneumatic Outputs (5) 24 VDC Outputs
Pneumatic Outputs	11
Supply Pressure	100 PSI
Pressure Drop	25 psi max.@ 0.25 scfm
External Solenoid Power	21.6-26.4 VDC, 24 VDC nominal
ON Response Time/Off Response Time	12 ms max. ON 12 ms max. OFF
Solenoid Inrush Current	33 mA/valve @ 24 VDC
Solenoid Holding Current	13 mA/valve @ 24 VDC
Output Fitting	Threaded for 10-32 adapter, 1/16" hose barb provided
Supply Fitting	Threaded for 10-32 adapter, 1/8" hose barb provided
Load Current per Point	0.5 A @ 30 VDC per point, 2.0 A total for all five points
Response Time (ms)	0.5 on/0.5 off
Output Type	Transistor
Polarity	Positive
Internal Power Used	75 mA from 5 VDC bus (solenoid LEDs are powered from external power source)



Programmable Coprocessor Modules

GE Series 90-30's feature a wide range of Specialty Modules to meet all of your application needs. From temperature controls, high-speed counters, I/O processors, coprocessors, to PID auto-tuning modules, these Specialty Modules are designed to meet the demand for versatile industrial solutions.

HE693ASC900

Product Name	Horner ASCII Basic Module
Lifecycle Status	Mature
Module Type	Co-Processor ASCII Basic Module
Programming Languages	BASIC
Program Storage	64K EEPROM
Communication Ports	RS-232, RS-232/485
Backplane Compatibility	No Restrictions
Internal Power Used	375 mA @ 5 VDC



Motion Modules (High Speed Counting)

Motion control integrated into the Series 90-30 fosters high performance point-to-point applications. GE Motion Control modules can be flexibly applied to a variety of digital, analog, and stepper motion applications.

	IC693APU300	IC693APU305
Product Name	Series 90-30 High Speed Counter	Series 90-30 I/O Processor Module
Lifecycle Status	Mature	Mature
Module Type	High Speed Counter	I/O Processor Module
Count Rate	High Frequency - 80 kHz; Low Frequency - 20 Hz	30 khz (Absolute Encoder) 200 khz (A Quad B Encoder)
Input/Output Type	Positive Logic	N/A
Off State Leakage Current	10 µA per point	10 µA per point
Output Protection	3 Amp Fuse for all points	5 A Fuse for all points
Counter Operation	Type A - Up or Down-Independent Pulse-4 counters; Type B - Both Directions-A QUAD B Encoder Inputs-2 Counters; Type C - Difference Between 2 changing values-A QUAD B Encoder Inputs -1 Counter	N/A
Input Filters (Selectable)	High Frequency Filter - 2.5 µS; Low Frequency Filter - 12.5 ms	N/A
Selectable On/Off Output Presets	Each Counter has 2 present points, On and Off	N/A
Counters per Timebase	Each counter stores the number of counts that have occurred in a specified time. A timebase value measurement from 1 ms to 65535 ms is configurable.	N/A
Strobe Register	Each counter has one or more strobe registers that capture the current accumulator value when a strobe input transition in the direction selected during the last configuration of the module.	N/A
Local Fast Inputs	(12) 5 VDC or 10 to 30 VDC	(12) 8.0 VDC (non-TTL), 1.5 VDC (TTL)
Local Fast Outputs	(4) 10 to 30 VDC @ 500 mA maximum 4.75 to 6 VDC @ 20 mA maximum	Continuous Output Current (10-30 VDC supply) 1.0 A (each output 1-4) 0.5 A (each output 5-V8)
Connector Type	Terminal Block (20 screws), included with module.	Terminal Block (20 screws), included with module.
Internal Power Used	250 mA @ 5 VDC	360 mA @ 5 VDC



Motion Modules (Servo Control)

Motion control integrated into the Series 90-30 fosters high performance point-to-point applications. GE Motion Control modules can be flexibly applied to a variety of digital, analog, and stepper motion applications.

	IC693DSM324	IC693DSM314
Product Name	Series 90-30 Digital Servo Module, 4-Axis	Series 90-30 Digital Servo Module, 4-Axis (Fiber Optic Interface to Amplifiers)
Lifecycle Status	Mature	Mature
Module Type	Servo Module	Servo Module
Drive	Beta i Series Digital Servos	Beta i Series Digital and Analog Servos
Drive Interface	Fiber Optic, Up to 100 meters between Amplifiers with total length of 400 meters.	Digital for Alpha and Beta Series. $\pm 10V$ velocity or torque command for analog
Axes	4 Digital	2 Digital and 1 analog or 4 analog
Encoder Support	Incremental Master (1Mhz)	Incremental Master (1Mhz)
Axis Configuration	Parallel or Cascade	Parallel or Cascade
User Memory	15 KBytes	15 KBytes
Analog Inputs	2	4 - In Digital Mode 8 - In Analog Mode
Analog Outputs	2	4 - In Digital Mode 0 - In Analog Mode
Local Fast Inputs	12 (24 V), 8 (5 V)	12 (24 V), 8 (5 V)
Local Fast Outputs	4 SSR Outputs (24 VDC, 125 mA)	4 SSR Outputs (24 VDC, 125 mA)
Connector Type	(1) 36 pin (5 VDC) (1) 24 pin (24 VDC)	(4) 36 pin
Internal Power Used	1360 mA @ 5 VDC	1300 mA @ 5 VDC



Remote Expansion Modules

The Ethernet distributed I/O interface (Ethernet Interface Unit), is a high performance Ethernet network interface module. The ENIU enables users to connect Series 90-30 I/O remotely over Ethernet to a master controller. The ENIU provides the power of Single Point of Connect. You can connect anywhere on the I/O network and monitor, configure, and troubleshoot any ENIU. The master controller is also accessible over the same network to program, troubleshoot and configure. The ENIU features a built-in Ethernet switch with two 10/100Mbit ports (RJ-45) allowing the user to daisy chain to the next ENIU. The ENIU automatically senses the cable type, eliminating the need for a crossover cable. The ENIU supports one IP address. Redundancy is provided as a standard feature with the ENIU.

IC693NIU004

Product Name	Ethernet Remote I/O Expansion (Slave)
Lifecycle Status	Mature
Module Type	Ethernet Remote I/O Interface Module
I/O Discrete Points	2048 Inputs/2048 Outputs maximum
I/O Analog Points	1264 Inputs and 512 Outputs maximum
User Logic Memory	N/A
Network Data Rate	10/100Mbit ports (RJ-45)
Entity Type	Slave
Network Distance	Media Dependent
Bus Diagnostics	Supported
Number of Drops Supported	Network Dependent. Each Ethernet NIU can also support up to 7 additional local I/O racks (IC693CHSxxx)
Internal Power Used	N/A

Accessories

Part Number	Description	Lifecycle Status
IC694TBB032	High Density 32 Point Terminal Block Box Style	Mature
IC694TBB132	High Density 32 Point Terminal Block Box Style with Extended Shroud for Large Wiring Bundles	Mature
IC694TBS032	High Density 32 Point Terminal Block Spring Style	Mature
IC694TBS132	High Density 32 Point Terminal Block Spring Style with Extended Shroud for Large Wiring Bundles	Mature
IC694TBC032	High Density 32 Point Terminal Block Connector Style (Fujitsu) with test points	Mature
IC690ACC901	Mini-Converter Kit with cable (RS-485/RS-232)	Mature
IC690ACC903	RS-485 Port Isolator	Mature
IC690CDR002	User Manuals, InfoLink CD-ROM Documentation, single-user license	Mature
IC693ACC301	Replacement Battery, CPU and PCM (qty 2)	Mature
IC693ACC302	High capacity battery pack. The new Auxiliary Battery Pack (IC693ACC302) will enable Series 90-30 (except CPU374) to go up to 75 months (shelf life of 10 years) of RAM memory backup w/no power and the CPU374 backup for 15 months	Mature
IC693ACC307	I/O Bus Terminator Plug	Mature
IC693ACC308	Rack Adaptor Bracket, Series 90-30 10 Slot to 19" (Front Mount)	Mature
IC693ACC310	Filler Module, Blank Slot	Mature
IC693ACC311	Twenty Point Terminal Blocks (qty 6)	Mature
IC200ACC003	EZ Store Device, CPU374 program download without the need of a PC.	Mature
IC693ACC319	Spare Plastic Cases Parts Kit (I/O, CPU, PCM)	Mature
IC693MLX000	Spare Series 90-30 I/O Modules Label Kit (various quantities)	Mature

Terminal Block Quick Connect

Terminal Block Quick Connect (TBQC) for selected I/O modules enables the user to easily connect interposing terminal blocks. The TBQC consists of an I/O faceplate adapter that includes a 24 pin Fujitsu male connector (the faceplate replaces the 20 screw terminal connector on front of I/O module, not compatible with the high density 36 screw terminals), cable and interposing terminal block.

TBQC I/O Module Face Plate Adapter

Part Number	Description	Lifecycle Status
IC693ACC334	I/O module face plate adapter for 20 screw type I/O modules. Faceplate provides a 24 pin male Fujitsu connector.	Mature

TBQC Interposing Terminal Block

Part Number	Description	Lifecycle Status
IC693ACC329	Interposing terminal block base for IC693MDL645, IC693MDL646, and IC693MDL240. The base can also be used with any 20 point terminal discrete or analog modules not listed.	Mature
IC693ACC332	Interposing terminal block base for IC693MDL940	Mature
IC693ACC333	Interposing terminal block base for IC693MDL340	Mature
IC693ACC337	Interposing terminal block base for IC693MDL654/655/752/753	Mature

TBQC Cables

Part Number	Description	Lifecycle Status
IC693CBL327	Cable, Left Side, One - 24 Pin 90 Degree Connector, 3 Meter. Cable has a connector on only one end and open on the other. Cable used with TBQC I/O Face Plate Adapter or Fujitsu style I/O modules.	Mature
IC693CBL328	Cable, Right Side, One - 24 Pin 90 Degree Connector, 3 Meter. Cable has a connector on only one end and open on the other. Cable used with TBQC I/O Face Plate Adapter or Fujitsu style I/O modules.	Mature
IC693CBL329	Cable, Left Side, One - 24 Pin 90 Degree Connector, 1 Meter. from TBQC I/O Face Plate Adapter to TBQC Interposing Terminal Block.	Mature
IC693CBL330	Cable, Right Side, One - 24 Pin 90 Degree Connector, 1 Meter. from TBQC I/O Face Plate Adapter to TBQC Interposing Terminal Block.	Mature
IC693CBL331	Cable, Left Side, One - 24 Pin 90 Degree Connector, 2 Meter. from TBQC I/O Face Plate Adapter to TBQC Interposing Terminal Block.	Mature
IC693CBL332	Cable, Right Side, One - 24 Pin 90 Degree Connector, 2 Meter. from TBQC I/O Face Plate Adapter to TBQC Interposing Terminal Block.	Mature
IC693CBL333	Cable, Left Side, One - 24 Pin 90 Degree Connector, 0.5 Meter. from TBQC I/O Face Plate Adapter to TBQC Interposing Terminal Block.	Mature
IC693CBL334	Cable, Right Side, One - 24 Pin 90 Degree Connector, 0.5 Meter. from TBQC I/O Face Plate Adapter to TBQC Interposing Terminal Block.	Mature

High Density Terminal Block Quick Connect

The High Density TBQC is simple to use — just attach the connector terminal block to the I/O module, snap the remote terminal base on the DIN-rail and attach the cable. Installation is accomplished in seconds versus up to an hour of cutting, stripping and wiring 36 individual wires. The High Density TBQC is compatible with IC695ALGxxx, IC69xMDL660 and IC694MDL664 modules only. Discrete output modules not supported.

HDTBQC I/O Module Face Plate Adapter

Part Number	Description	Lifecycle Status
IC694TBC032	High-density, 36-point, terminal block with cable connector. IC695ALGxxx, IC69xMDL660 and IC694MDL664 modules only. Discrete output modules not supported.	Mature

HDTBQC Interposing Terminal Block

Part Number	Description	Lifecycle Status
IC694RTB032	High-density remote base, 36-point, with shield ground lug and removable terminal blocks. IC695ALGxxx, IC69xMDL660 and IC694MDL664 modules only. Discrete output modules not supported.	Mature

HDTBQC Interface Cables

Part Number	Description	Lifecycle Status
IC694CBL005	Shielded 0.5 meter cable with termination on both ends. IC694TBC032 and IC694RTB032 only.	Mature
IC694CBL010	Shielded 1.0 meter cable with termination on both ends. IC694TBC032 and IC694RTB032 only.	Mature
IC694CBL030	Shielded 3.0 meter cable with termination on both ends. IC694TBC032 and IC694RTB032 only.	Mature
IC694CBL130	Shielded 3.0 meter cable with termination on one end that connects to the IC694TBC032 terminal block. The other end of the cable is non-terminated wires.	Mature

External Power Supplies

Part Number	Description	Lifecycle Status
IC690PWR024	Field Power Supply 24 VDC 5 Amps	Mature
IC690PWR124	Field Power Supply 24 VDC 10 Amps	Mature

Rack to Rack Expansion Cables

Part Number	Description	Lifecycle Status
IC693CBL300	Cable, I/O Base Expansion, 1 Meter, Shielded	Mature
IC693CBL301	Cable, I/O Base Expansion, 2 Meters, Shielded	Mature
IC693CBL302	Cable, I/O Base Expansion, 15 Meters, Shielded with built-in terminator	Mature
IC693CBL312	Cable, I/O Base Expansion, 0.15 Meter, Shielded	Mature
IC693CBL313	Cable, I/O Base Expansion, 8 Meters, Shielded	Mature
IC693ACC307	I/O Bus Terminator Plug	Mature

Configuration Guidelines

When configuring a Series 90-30 the following guidelines should be considered

1. High density IC693 I/O modules require a terminal block assembly. IC694TBSxxx (spring clamp termination) or IC694TBBxxx (box style termination) are required.
2. If the CPU is powered down frequently a high capacity battery should be considered. (IC693ACC302)
3. Add up the power consumption to ensure enough power supply capacity.

Examples of Typical Application

Configuration for Controller (Example application requiring (120) 24 VDC inputs and (80) Relay outputs AC power supply)

Power Supply Current Required (mA)	Qty	Part Number	Description
670 mA @ 5 VDC	1	IC693CPU350	CPU with 32K of memory
	1	IC693PWR321	120/240 VAC, 125 VDC Power Supply, 3 Amps @ 5 VDC; 0.625 @ 24 VDC relay and 0.833 @ 24 VDC isolated
420 mA @ 5 VDC	1	IC693CHS391	10 Slot CPU Base
1200 mA @ 5 V	4	IC693MDL660	Discrete Input Module, 24 VDC Positive Logic, 32 points (Requires terminal block)
35 mA @ 5 V; 110 mA @ 24 VDC Relay	5	IC693MDL940	Discrete Output Module, Relay 2.0 A per point Form A, 16 points (Terminal block included).
	4	IC694TBB032	Terminal Block, Box Style
	1	BC646MPS001	Logic Developer - PLC Standard - w/Programming Cable
Total current from power supply required:	2325 mA @ 5 V; 110 mA @ 24 VDC Relay.		

Options to consider

1.4 Amps @ 5 VDC	1	IC693CPU374	CPU with built-in Ethernet 10/100Mbps and Web support
	1	IC690PWR024	24 VDC, 5 Amp Output Power and 120/230 VAC Input Power Power Supply
	1	IC693ACC302	Long term battery for CPU
	1	IC754VSI06STD	QuickPanel View Intermediate 6 inch STN Touch Operator Interface

Configuration for Controller (100) 24 VDC inputs, (50) 24 VDC Outputs with ESCP protection, (20) Relay outputs, (12) 4 to 20 mA Analog Inputs, (12) 4 to 20 mA Analog Outputs and 24 VDC power supply. Also requires PROFIBUS Master and Ethernet communications.

Power Supply Current Required	Qty	Part Number	Description
1.4 Amps @ 5 VDC	1	IC693CPU374	CPU with built-in Ethernet 10/100 Mbps and Web support
	2	IC693PWR331	24 VDC Power Supply, current available 6 Amps @ 5 VDC; 0.625 Amps @ 24 VDC relay; 0.833 @ 24 VDC isolated
420 mA @ 5 VDC	1	IC693CHS391	10 Slot CPU Base
1200 mA @ 5 VDC	4	IC693MDL660	Discrete Input Module, 24 VDC Positive Logic, 32 points (Requires terminal block)
600 mA @ 5 VDC	2	IC693MDL754	Discrete Output Module, 24 VDC Output with ESCP, 32 points (Requires terminal block)
35 mA @ 5 VDC; 110 mA @ 24 VDC Relay	2	IC693MDL940	Discrete Output Module, Relay 2.0 A per point Form A, 16 points (Terminal block included).
120 mA @ 5 VDC; 65 mA-User Supplied 24 VDC	1	IC693ALG223	Analog Input, 16 channels, current. (Terminal block included).
220 mA @ 5 VDC; 630 mA-User Supplied 24 VDC	2	IC693ALG392	Analog Output module, supports voltage and current, 8 channels (Terminal block included).
450 mA @ 5 VDC	1	IC693PBM200	PROFIBUS Master module, supports V0
150 mA @ 5VDC	1	IC693CHS392	10 slot I/O expansion rack
	1	IC693CBL312	Rack Expansion Cable, 0.15 meters
	1	IC693ACC307	I/O Bus Terminator Plug
	6	IC694TBB032	Terminal Block, Box Style
	1	BC646MPS001	Logic Developer - PLC Standard - w/Programming Cable

In the above configuration, all of the modules cannot go into one base. Therefore the I/O modules are divided into two bases.

Options to consider

1	1	IC200ACC003	EZ Store Device, CPU374 program download without the need of a PC.
	1	IC690PWR024	24 VDC, 5 Amp Output Power and 120/230 VAC Input Power Power Supply
	1	IC693ACC302	Long term battery for CPU
	1	IC754VSI06STD	QuickPanel View Intermediate 6 inch STN Touch Operator Interface

PACSystems RX7i Controllers

Built on a standard embedded open architecture, the PACSystems RX7i is the first member of the groundbreaking PACSystems family of programmable controllers (PACs). The RX7i features a single control engine and universal programming environment to provide application portability across multiple hardware platforms. Designed to address mid- to high-end applications for OEMs, integrators, and end users, the RX7i is ideally suited for integrated solutions that require open architecture, large memory, distributed I/O and high performance.

The RX7i Features

- Pentium® CPUs for your every need, from Celeron 300mHz to M Class 1.8 Ghz
 - VME64 architecture supporting new and older VME embedded technology with fast through put of large amounts of data.
 - 10/100 Ethernet built into the CPU, with easy cabling RJ-45 dual ports connected through an auto-sensing switch, so there is no need for additional switches or hubs rack to rack
 - Up to 64 MB memory for fast execution, storage of the complete program with all documentation—all in one CPU
- In addition, it provides an outstanding migration path for any Series 90 applications to move to the PACSystems architecture.

Machine Edition

Machine Edition is an advanced software environment for the development and maintenance of machine level automation. Visualization, motion control, and execution logic are developed with a single programmer.

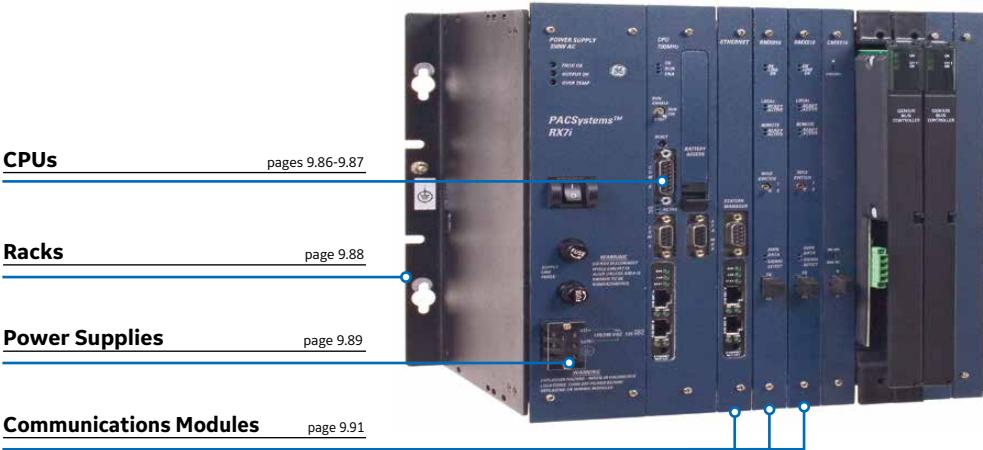

CPUs [pages 9.86-9.87](#)

Racks [page 9.88](#)

Power Supplies [page 9.89](#)

Communications Modules [page 9.91](#)

I/O Interface Modules [page 9.90](#)

Accessories [page 9.92](#)

Publication Reference Chart

GFK-2222	PACSystems CPU Reference Manual
GFK-2223	PACSystems RX7i Installation Manual
GFK-2224	TCP/IP Ethernet Communications for PACSystems
GFK-2225	PACSystems Station Manager User's Manual
GFK-2235	PACSystems RX7i User's Guide to Integration of VME Modules
GFK-2259	C Programmer's Toolkit for PACSystems User's Manual
GFK-2300	PACSystems RX7i Memory Xchange Modules User's Manual
GFK-2308	PACSystems Hot Standby CPU Redundancy User's Guide



CPUs

PACSystems RX7i CPUs feature Intel Celeron and Pentium III processors and offer fast execution, larger memory capacity and upgradability to track future technology growth. RX7i CPUs are available with various memory sizes, performance capabilities and advanced functionalities, such as software configuration of data and program memory. PACSystems CPUs also provide 10K of user RAM along with 10K of non-volatile user flash memory for added protection of your data and programs.

	IC698CPE020[†]	IC698CRE020[†]
Product Name	Central Processing Unit, 700 MHz, Floating Point	Redundancy Central Processing Unit, 700 MHz, Floating Point
Lifecycle Status	Mature	Mature
PACSystems Processor Speed	700 MHz	700 MHz
PACSystems CPU Memory	10 Mbytes of User Logic RAM	10 Mbytes of User Logic RAM
PACSystems User Flash Memory	Yes (10 Mbytes)	Yes (10 Mbytes)
Floating Point Math	Yes	Yes
PACSystems I/O Discrete Points Available	32 Kbits	32 Kbits
Other Memory Allocations	%W: Configurable up to 4 Mbytes, Symbolic: Configurable up to 10 Mbytes	%W: Configurable up to the maximum available user RAM, Symbolic: Configurable up to 10 Mbytes
Embedded Communications	Serial, Ethernet	Serial, Ethernet
Protocols Supported	Modbus RTU Slave, SNP, Serial I/O	Modbus RTU Slave, SNP, Serial I/O
Built-in Ports	2 Serial (RS-232, RS-485) 1 Ethernet (Auto 10/100, RJ45)	2 Serial (RS-232, RS-485) 1 Ethernet (Auto 10/100, RJ45)
Current Required from 5V Bus	4.0 Amps	4.0 Amps

[†]Requires fan kit.



CPUs

PACSystems RX7i CPUs feature Intel Celeron and Pentium III processors and offer fast execution, larger memory capacity and upgradability to track future technology growth. RX7i CPUs are available with various memory sizes, performance capabilities and advanced functionalities, such as software configuration of data and program memory. PACSystems CPUs also provide 10K of user RAM along with 10K of non-volatile user flash memory for added protection of your data and programs.

	IC698CPE030	IC698CPE040[†]	IC698CRE030	IC698CRE040[†]
Product Name	Pentium M Central Processing Unit, 600 MHz	Pentium M Central Processing Unit, 1.8 GHz	Pentium M Redundancy Central Processing Unit, 600 MHz	Pentium M Redundancy Central Processing Unit, 1.8 GHz
Lifecycle Status	Mature	Mature	Mature	Mature
PACSystems Processor Speed	600 MHz	1.8 GHz	600 MHz	1.8 GHz
PACSystems CPU Memory	64 Mbytes	64 Mbytes	64 Mbytes	64 Mbytes
PACSystems User Flash Memory	64 Mbytes	64 Mbytes	64 Mbytes	64 Mbytes
Floating Point Math	Yes	Yes	Yes	Yes
PACSystems I/O Discrete Points Available	32 Kbits	32 Kbits	32 Kbits	32 Kbits
Other Memory Allocations	%W: Configurable up to the maximum available user RAM Symbolic: Configurable up to the maximum available user RAM	%W: Configurable up to the maximum available user RAM Symbolic: Configurable up to the maximum available user RAM	%W: Configurable up to the maximum available user RAM Symbolic: Configurable up to the maximum available user RAM	%W: Configurable up to the maximum available user RAM Symbolic: Configurable up to the maximum available user RAM
Embedded Communications	Serial, Ethernet	Serial, Ethernet	Serial, Ethernet	Serial, Ethernet
Protocols Supported	Modbus RTU Slave, SNP, Serial I/O	Modbus RTU Slave, SNP, Serial I/O	Modbus RTU Slave, SNP, Serial I/O	Modbus RTU Slave, SNP, Serial I/O
Built-in Ports	2 Serial (RS-232, RS-485) 1 Ethernet (Auto 10/100, RJ45)	2 Serial (RS-232, RS-485) 1 Ethernet (Auto 10/100, RJ45)	2 Serial (RS-232, RS-485) 1 Ethernet (Auto 10/100, RJ45)	2 Serial (RS-232, RS-485) 1 Ethernet (Auto 10/100, RJ45)
Current Required from 5V Bus	3.2 A	6.8 A	3.2 A	6.8 A
Web Based Data Monitoring	up to 16 web server and FTP connections (combined)	up to 16 web server and FTP connections (combined)	up to 16 web server and FTP connections (combined)	up to 16 web server and FTP connections (combined)

[†]Requires fan kit.

Racks



PACSystems RX7i Racks set the pace for the latest PLC technology. They are built to support the high-power PACSystems power supplies along with the latest technology in the PACSystems CPUs. The VME64 backplane provides up to four times the bandwidth of existing VME based systems for faster I/O throughput. The VME64 base supports all standard VME modules including I/O and VMIC modules.

	IC698CHS009	IC698CHS017	IC698CHS109	IC698CHS117	IC698CHS217
Product Name	Standard PACSystems 9-slot Wall (Rear) Mount	Standard PACSystems 18-slot Wall (Rear) Mount	Standard PACSystems 9-slot Wall (Panel) Mount	Standard PACSystems 18-slot Wall (Panel) Mount	PACSystems 17-slot Wall (Rear) Mount, Rear I/O Access
Lifecycle Status	Mature	Mature	Mature	Mature	Mature
Number of Slots	9 Single Width, 5 Double Width (plus one for power supply)	15 Single Width, 8 Double Width (plus one for power supply)	9 Single Width, 5 Double Width (plus one for power supply)	15 Single Width, 8 Double Width (plus one for power supply)	17 Single Width, 8 Double Width (plus one for power supply)
Mounting Location	Rear (Panel)	Rear (Panel)	Front (Rack)	Front (Rack)	Rear (Panel)
Rack Configurations	RX7i CPU and I/O, VME modules	RX7i CPU and I/O, VME modules	RX7i CPU and I/O, VME modules	RX7i CPU and I/O, VME modules	RX7i CPU and I/O, VME modules (with or without rear access connections)
Rack Slot Size	0.8 inch	0.8 inch	0.8 inch	0.8 inch	0.8 inch
Compatible Power Supplies	RX7i Power Supply (IC698)	RX7i Power Supply (IC698)	RX7i Power Supply (IC698)	RX7i Power Supply (IC698)	RX7i Power Supply (IC698)
Dimensions	11.15"H x 12.6"W x 7.25"D (283 x 320 x 184mm)	11.15" x 19.00" x 7.5"	11.15"H x 12.6"W x 7.25"D (283 x 320 x 184mm)	11.15" x 19.00" x 7.5"	11.15"H x 19"W x 8.875"D (8.97"D with rear I/O cover) (283 x 483 x 225mm) (228mm D with rear I/O cover)



Power Supplies

PACSystems RX7i Power Supply modules simply slide into the PLC rack just like I/O, and they work with any PACSystems CPU. The low capacity power supply delivers up to 100W total output without forced air cooling. The high capacity power supply accommodates applications requiring more power, providing up to 350W total output, and requires forced air cooling, provided by a fan tray mounted on the bottom of the rack. PACSystems power supplies also have built-in protection for autoranging power factor corrections as well as overcurrent, overvoltage, and overtemperature fault conditions.

	IC698PSA100	IC698PSA350	IC698PSD300
Product Name	PACSystems Power Supply, 100 W	PACSystems Power Supply, 350 W	PACSystems Power Supply, 300 W
Lifecycle Status	Mature	Mature	Mature
Power Source	85-264 VAC or 125 VDC	85-264 VAC or 125 VDC	18-30 VDC
Output Source	100 Watts; 5 VDC @ 20 Amps, +12 VDC @ 2 Amps, -12 VDC @ 1 Amp	350 Watts; 5 VDC @ 60 Amps, +12 VDC @ 12 Amps, -12 VDC @ 4 Amps	300 Watts; 5 VDC @ 50 Amps, +12 VDC @ 10 Amps, -12 VDC @ 4 Amps



I/O Interface Modules

PACSystems features a variety of communications options for distributed control and/or I/O, supporting a wide range of communication protocols and configurations. These communication modules are easy to install and quick to configure. Some distributed I/O communications modules allow for numerous remote drops or additional racks, while others provide an interface for GE products up to 7500 feet away from the controller.

	IC697BEM731	IC687BEM731	IC697BEM713	IC697BEM711	IC697BEM733
Product Name	Genius Bus Controller	VME Single Slot Bus Controller	Bus Transmitter Module	Bus Receiver Module	Remote I/O Scanner
Lifecycle Status	Mature	Mature	Mature	Mature	Mature
Module Type	Bus Controller	Bus Controller	Bus Transmitter	Bus Receiver Scanner	Remote I/O
Supports Redundancy	Yes	Yes	No	No	Yes
Discrete Points Available	N/A	N/A	N/A	N/A	128 Bytes Per Drop
Programmer Effective Data Rate	N/A	N/A	500 Kbytes/sec	N/A	N/A
Time to Store 16 Kbyte Program	N/A	N/A	20 - 30 Seconds	N/A	N/A
Effective Data Rate	N/A	N/A	500 Kbytes/sec	500 Kbytes/sec	38.4 Kbaud
Total Allowed Distance of Interconnecting Cable	N/A	N/A	50 feet (15 meters)	50 feet (15 meters)	N/A
Maximum Distance from Controller	N/A	N/A	N/A	N/A	7500 feet (2275 meters)
Electrical Isolation	N/A	N/A	Non-isolated differential communication	Non-isolated differential communication	N/A
Built-in Serial Ports	1 (Hand Held Monitor Port)	1 (Hand Held Monitor Port)	2 (Programmer Port, Expansion Port Out)	2 (Expansion Port In, Expansion Port Out)	2 (RS-422 Compatible Serial Port, Hand Held Monitor Port)
Current Required from 5V Bus	1.3 Amps	1.3 Amps	1.4 Amps	0.8 Amp	0.8 Amp



Communications Modules

PACSystems features a variety of communications options for distributed control and/or I/O, supporting a wide range of communication protocols and configurations. These communication modules are easy to install and quick to configure. Some distributed I/O communications modules allow for numerous remote drops or additional racks, while others provide an interface for GE products up to 7500 feet away from the controller.

	IC698RMX016	IC698CMX016	IC698ETM001
Product Name	Redundancy Memory Xchange Module	Control Memory Xchange Module	RX7i Standalone Ethernet Module 10/100
Lifecycle Status	Mature	Mature	Mature
Module Type	Redundancy Communications (High Availability)	Control Memory Xchange	Ethernet Controller
Supports Redundancy	Yes	No	No
Protocols Supported	N/A	N/A	N/A
Effective Data Rate	2.12 gigabaud	2.12 gigabaud	N/A
Electrical Isolation	Non-isolated differential communication	Non-isolated differential communication	N/A
Communications Processor Speed	N/A	N/A	N/A
Simultaneous Communication Speed	N/A	N/A	N/A
Individual Communication Speed	N/A	N/A	N/A
Reflective Memory Available	16 Mbytes	16 Mbytes	N/A
Distance Between Nodes	Up to 300 meters	Up to 300 meters	N/A
Access Time	400 ns (worst-case), 200 ns (best-case)	400 ns (worst-case), 200 ns (best-case)	N/A
Transfer Rate	6.2 Mbyte/s without redundant transfer, 3.2 Mbyte/s with redundant transfer	6.2 Mbyte/s without redundant transfer, 3.2 Mbyte/s with redundant transfer	N/A
Cable Requirements	Connector (LC type, conforms to IEC61754-20) Cable (ST Type Fiber-Optic Multimode; 62.5 Micron core)	Connector (LC type, conforms to IEC61754-20) Cable (ST Type Fiber-Optic Multimode; 62.5 Micron core)	N/A
Built-in Serial Ports	None	None	2 Twisted pair 10 Base T/100 Base TX RJ-45
Current Required from 5V Bus	1.2 Amps	1.2 Amps	N/A

Accessories

Part Number	Description	Lifecycle Status
IC690CDR002	User Manuals, InfoLink CD-ROM Documentation, Single-user License	Mature
IC697ACC621	Short Rack Fan Assembly, 120 VAC	Mature
IC697ACC624	Short Rack Fan Assembly, 240 VAC	Mature
IC697ACC644	Short Rack Fan Assembly, 24 VDC	Mature
IC697ACC721	Rack Fan Assembly, 120 VAC	Mature
IC697ACC724	Rack Fan Assembly, 240 VAC	Mature
IC697ACC736	Cable Shield Clamping Assembly	Mature
IC697ACC744	Rack Fan Assembly, 24 VDC	Mature
IC698ACC701	Replacement Battery	Mature
IC698ACC720	Gasketed Filler Faceplate, Double-width	Mature
IC698ACC735	Gasketed Filler Faceplate, Single-width	Mature

Cables

Part Number	Description	Lifecycle Status
IC200CBL001	Station Manager Cable for Ethernet Interface	Mature
IC600WD002	I/O Expansion Cable, 2 feet (0.6 meters)	Mature
IC600WD005	I/O Expansion Cable, 5 feet (1.5 meters)	Mature
IC600WD010	I/O Expansion Cable, 10 feet (3.0 meters)	Mature
IC600WD025	I/O Expansion Cable, 25 feet (7.5 meters)	Mature
IC600WD050	I/O Expansion Cable, 50 feet (15 meters)	Mature

Genius Distributed I/O

By providing distributed control on the factory floor, Genius I/O systems offer fewer terminations to document, dramatically shorter wiring runs, and simpler, more effective troubleshooting. Genius I/O blocks automatically provide diagnostic information on field wiring, power conditions and loads, as well as the state of the communication network, blocks and circuits. Genius diagnostics sharply reduce the time needed for initial control and debugging.

Genius blocks provide predictable system operation in the event of a CPU, bus interface or network cable failure. When connected in a redundant configuration

with two or more CPUs running simultaneously, the Genius blocks will shift automatically to a backup CPU if the main controller fails to communicate.

Genius blocks communicate with the system CPU over the Genius LAN, greatly simplifying system installation, and with network tools such as the handheld monitor, troubleshooting is a snap. In addition to Genius I/O blocks, VersaMax I/O may also be integrated into a single Genius LAN.

AC Discrete I/O Modules	page 9.94
DC Discrete I/O Modules	pages 9.95-9.96
Analog Input Modules	page 9.97
Analog Output Modules	page 9.98
Analog Mixed Modules	page 9.99
RTD and Thermocouple Modules	page 9.100
High Speed Counter	page 9.101
PowerTRAC Monitoring Module	page 9.102
Accessories	page 9.103
Configuration Guidelines	pages 9.104-9.105



Publication Reference Chart

GEK-90486D	I/O Discrete and Analog Blocks
GEK-90486F-1	I/O System and Communications
GFK-0074A	Genius I/O PCIM User's Manual
GFK-0415E	High Speed Counter
GFK-0450D	PowerTRAC
GFK-0881	Single Slot Personal Computer Interface Module (PCIM)
GFK-1179J	Installation Requirements for Conformance to Standards



AC Discrete I/O Modules

Control power for the block is tapped off the input/output device voltages wired to the terminals. No separate block power supply is needed. Configurable features include; Output Pulse Test capability, Selectable Input Filter Time from 10mS to 100mS, Output powerup defaults, Output Hold Last State or default, each circuit has electronic fusing.

	IC660BBD110	IC660BBD101	IC660BBS102	IC660BBS103	IC660BBR100	IC660BBR101
Product Name	Genius Discrete Input Block, 115 VAC Grouped, 16 Point	Genius Discrete I/O Block, 115 VAC Grouped, 8 Point	Genius Discrete I/O Block, 115 VAC/125 VDC Isolated, 8 Point	Genius Discrete I/O Block, 115 VAC/125 VDC Isolated, 8 Point, w/o Failed Switch Diagnostic	Genius Relay Output Block, Grouped, 16 Points, Normally Closed	Genius Relay Output Block, Grouped, 16 Points, Normally Open
Lifecycle Status	Mature	Mature	Mature	Mature	Mature	Mature
Network Support	Genius Bus	Genius Bus	Genius Bus	Genius Bus	Genius Bus	Genius Bus
Input Range	93-132 VAC	93-132 VAC	115 VAC / 125 VDC	115 VAC / 125 VDC	N/A	N/A
Output Range	N/A	93-132 VAC	115 VAC / 125 VDC	115 VAC / 125 VDC	5V to 250 VAC or 5V to 220 VDC; Relay Normally-Closed Relays	5V to 250 VAC or 5V to 220 VDC; Relay Normally-Open Relays
Number of Points	16	8	8	8	16	16
Input and Output Response Time - ON/OFF (msec.)	Input 1 msec plus configurable filter 10 to 100mS in 10mS increments	Input 2msec plus configurable filter 10 to 100mS in 10mS increments; Outputs Zero crossing	Input 2msec plus configurable filter 10 to 100mS in 10mS increments; Outputs Zero crossing	Input 2msec plus configurable filter 10 to 100mS in 10mS increments; Outputs Zero crossing	5.0 msec.	5.0 msec.
Input Impedance	11.6K ohms	13K ohms	13K ohms	13K ohms	N/A	N/A
Load Current Per Point	N/A	2 Amp	2.0 Amp	2.0 Amp	2 Amp	2 Amp
Points Per Common	Two groups of 8	One group of 8	Four groups of 2	Four groups of 2	Four groups of 4	Four groups of 4
Protection	N/A	Internal electronic short circuit trip. 100ms long time trip	Internal electronic short circuit trip. 100ms (AC), 10ms (DC) long time trip	Internal electronic short circuit trip. 100ms (AC), 10ms (DC) long time trip	N/A	N/A
Diagnostics	Input Diagnostics: Open Wire, Short Circuit	Input Diagnostics: Open Wire, Overtemperature, Failed Switch Output Diagnostics: Short Circuit, Overload, No Load, Failed Switch, Overtemperature, Pulse Test	Input Diagnostics: Open Wire, Overtemperature, Loss of I/O Power, Failed Switch Output Diagnostics: Short Circuit, Overload, No Load, Overtemp., Loss of I/O Power, Failed Switch, Pulse Test	Input Diagnostics: Open Wire, Overtemperature, Loss of I/O Power, Failed Switch Output Diagnostics: Short Circuit, Overload, No Load, Overtemp., Loss of I/O Power, Failed Switch, Pulse Test	None	None
Operating Voltage	93-132 VAC	93-132 VAC	93-132 VAC / 105-132 VDC	93-132 VAC / 105-132 VDC	93-132 VAC / 185-265 VAC	93-132 VAC / 185-265 VAC
Dimensions (H x W x D)	8.83" (22.44cm) x 3.50" (8.89cm) x 3.94" (10.00cm)	8.83" (22.44cm) x 3.50" (8.89cm) x 3.94" (10.00cm)	8.83" (22.44cm) x 3.50" (8.89cm) x 3.94" (10.00cm)	8.83" (22.44cm) x 3.50" (8.89cm) x 3.94" (10.00cm)	8.83" (22.44cm) x 3.50" (8.89cm) x 3.94" (10.00cm)	8.83" (22.44cm) x 3.50" (8.89cm) x 3.94" (10.00cm)



DC Discrete I/O Modules

Genius DC Discrete I/O blocks interface to a wide range of input devices, including both 2-wire and 3-wire electronic proximity switches. Outputs may be low-power control and indicating devices such as relays, contactors, and lamps. These blocks have identical discrete I/O circuits, each easily configured to be an input or an output. Output circuits can be directly connected to input circuits without the use of other components or inversion of logic states. This flexibility provides maximum design and application efficiency. Each circuit contains built-in protection when used as an output, protecting the driver while allowing short-time surges. It also protects against shorted loads caused by wiring errors.

	IC660BBD020	IC660BBD021	IC660BBD022	IC660BBD023	IC660BBD024
Product Name	Genius Discrete I/O Block, 24/48 VDC Grouped, 16 Point, Source	Genius Discrete I/O Block, 24/48 VDC Grouped, 16 Point, Sink	Genius Discrete I/O Block, 24 VDC Grouped, 16 Point, Source	Genius Discrete I/O Block, 24 VDC Grouped, 16 Point, Sink	Genius Discrete I/O Block, 12/24 VDC Grouped, 32 Point, Source
Lifecycle Status	Mature	Mature	Mature	Mature	Mature
Network Support	Genius Bus	Genius Bus	Genius Bus	Genius Bus	Genius Bus
Input Range	18-56 VDC (24/48 V)	18-56 VDC (24/48 V)	18-30 VDC (24 V)	18-30 VDC (24 V)	18-30 VDC (24 V)
Sink/Source	Source	Sink	Source	Sink	Source
Output Range	18-56 VDC (24/48 V)	18-56 VDC (24/48 V)	18-30 VDC (24 V)	18-30 VDC (24 V)	18-30 VDC (24 V)
Number of Points	16	16	16	16	32
Input and Output Response Time - ON/OFF (msec.)	Input 1.7 msec plus configurable filter: 5 to 100mS for input; Output 1.0 msec	Input 1.7 msec plus configurable filter: 5 to 100mS for input; Output 1.0 msec	Input 1.7 msec plus configurable filter: 5 to 100mS for input; Output 1.0 msec	Input 1.7 msec plus configurable filter: 5 to 100mS for input; Output 1.0 msec	Input 1.4 msec plus configurable filter: 1 to 100mS for input; Output 0.5 msec
Input Impedance	5.6K ohms (24/48 V), 1.8K ohms (24 V)	5.6K ohms (24/48 V), 1.8K ohms (24 V)	5.6K ohms (24/48 V), 1.8K ohms (24 V)	5.6K ohms (24/48 V), 1.8K ohms (24 V)	3.3 K ohms
Load Current Per Point	2 Amp	2 Amp	2 Amp	2 Amp	0.5 Amp
Points Per Common	One group of 16	One group of 16	One group of 16	One group of 16	One group of 32
Protection	Short circuit level sensor at the switching device	Short circuit level sensor at the switching device	Short circuit level sensor at the switching device	Short circuit level sensor at the switching device	Short circuit level sensor at the switching device
Diagnostics	Input Diagnostics: Open wire, Overtemperature, Failed Switch Output Diagnostics: Short Circuit, Overload, No Load, Failed Switch, Overtemperature, Pulse Test	Input Diagnostics: Open wire, Overtemperature, Failed Switch Output Diagnostics: Short Circuit, Overload, No Load, Failed Switch, Overtemperature, Pulse Test	Input Diagnostics: Open wire, Overtemperature, Failed Switch Output Diagnostics: Short Circuit, Overload, No Load, Failed Switch, Overtemperature, Pulse Test	Input Diagnostics: Open wire, Overtemperature, Failed Switch Output Diagnostics: Short Circuit, Overload, No Load, Failed Switch, Overtemperature, Pulse Test	Output Diagnostics: Short Circuit, Overload, Failed Switch, Pulse Test
Operating Voltage	18-56 VDC (24/48 V)	18-56 VDC (24/48 V)	18-30 VDC (24 V)	18-30 VDC (24 V)	10-30 VDC
Dimensions (H x W x D)	8.83" (22.44cm) x 3.50" (8.89cm) x 3.94" (10.00cm)	8.83" (22.44cm) x 3.50" (8.89cm) x 3.94" (10.00cm)	8.83" (22.44cm) x 3.50" (8.89cm) x 3.94" (10.00cm)	8.83" (22.44cm) x 3.50" (8.89cm) x 3.94" (10.00cm)	8.83" (22.44cm) x 3.50" (8.89cm) x 3.94" (10.00cm)



DC Discrete I/O Modules

Genius DC Discrete I/O blocks interface to a wide range of input devices, including both 2-wire and 3-wire electronic proximity switches. Outputs may be low-power control and indicating devices such as relays, contactors, and lamps. These blocks have identical discrete I/O circuits, each easily configured to be an input or an output. Output circuits can be directly connected to input circuits without the use of other components or inversion of logic states. This flexibility provides maximum design and application efficiency. Each circuit contains built-in protection when used as an output, protecting the driver while allowing short-time surges. It also protects against shorted loads caused by wiring errors.

	IC660BBD025	IC660BBS102	IC660BBS103	IC660BBR100	IC660BBR101
Product Name	Genius Discrete I/O Block, 5/12/24 VDC Grouped, 32 Point, Sink	Genius Discrete I/O Block, 115 VAC/125 VDC Isolated, 8 Point	Genius Discrete I/O Block, 115 VAC/125 VDC Isolated, 8 Point, w/o Failed Switch Diagnostic	Genius Relay Output Block, Grouped, 16 Points, Normally Closed	Genius Relay Output Block, Grouped, 16 Points, Normally Open
Lifecycle Status	Mature	Mature	Mature	Mature	Mature
Network Support	Genius Bus	Genius Bus	Genius Bus	Genius Bus	Genius Bus
Input Range	10-30 VDC (12/24 V), 4.9-5.3 VDC (5 V)	115 VAC / 125 VDC	115 VAC / 125 VDC	N/A	N/A
Sink/Source	Sink	N/A	N/A	N/A	N/A
Output Range	10-30 VDC (12/24 V), 4.9-5.3 VDC (5 V)	115 VAC / 125 VDC	115 VAC / 125 VDC	5V to 250 VAC or 5V to 220 VDC; Relay Normally-Closed Relays	5V to 250 VAC or 5V to 220 VDC; Relay Normally-Open Relays
Number of Points	32	8	8	16	16
Input and Output Response Time - ON/OFF (msec.)	Input 1.4 msec plus configurable filter: 1 to 100mS for input; Output 0.5 msec	Input 2msec plus configurable filter 10 to 100mS in 10mS increments; Outputs Zero crossing	Input 2msec plus configurable filter 0 to 100mS in 10mS increments; Outputs Zero crossing	5.0 msec.	5.0 msec.
Input Impedance	3.3 K ohms	13K ohms	13K ohms	N/A	N/A
Load Current Per Point	0.5 Amp	2.0 Amp	2.0 Amp	2 Amp	2 Amp
Points Per Common	One group of 32	Four groups of 2	Four groups of 2	Four groups of 4	Four groups of 4
Protection	Short circuit level sensor at the switching device	Internal electronic short circuit trip. 100ms (AC), 10ms (DC) long time trip	Internal electronic short circuit trip. 100ms (AC), 10ms (DC) long time trip	N/A	N/A
Diagnostics	Output Diagnostics: Short Circuit, Overload, Failed Switch, Pulse Test	Input Diagnostics: Open Wire, Overtemperature, Loss of I/O Power, Failed Switch Output Diagnostics: Short Circuit, Overload, No Load, Overtemp., Loss of I/O Power, Failed Switch, Pulse Test	Input Diagnostics: Open Wire, Overtemperature, Loss of I/O Power, Failed Switch Output Diagnostics: Short Circuit, Overload, No Load, Overtemp., Loss of I/O Power, Failed Switch, Pulse Test	None	None
Operating Voltage	10-30 VDC (12/24 V), 4.9-5.3 VDC (5 V)	93-132 VAC / 105-132 VDC	93-132 VAC / 105-132 VDC	93-132 VAC / 185-265 VAC	93-132 VAC / 185-265 VAC
Dimensions (H x W x D)	8.83" (22.44cm) x 3.50" (8.89cm) x 3.94" (10.00cm)	8.83" (22.44cm) x 3.50" (8.89cm) x 3.94" (10.00cm)	8.83" (22.44cm) x 3.50" (8.89cm) x 3.94" (10.00cm)	8.83" (22.44cm) x 3.50" (8.89cm) x 3.94" (10.00cm)	8.83" (22.44cm) x 3.50" (8.89cm) x 3.94" (10.00cm)



Analog Input Modules

Genius Analog Input blocks provide 6 channels of current inputs with powerful diagnostics.

	IC660BBA026	IC660BBA106
Product Name	Genius Analog Input Block, Current-source, 6 Channels, 24/48 VDC Powered	Genius Analog Input Block, Current-source, 6 Channels, 115 VAC/125 VDC Powered
Lifecycle Status	Mature	Mature
Network Support	Genius Bus	Genius Bus
Input Range	4 mA to 20 mA 0 mA to 25 mA	4 mA to 20 mA 0 mA to 25 mA
Number of Points	6	6
Points Per Common	Channel to Channel Isolation. 6 isolated points	Channel to Channel Isolation. 6 isolated points
Resolution	1 micro Amp	1 micro Amp
Update Rate	16.6mS to 400mS (user selectable)	16.6mS to 400mS (user selectable)
Accuracy	0.1% of full scale reading	0.1% of full scale reading
Diagnostics	Underrange, Overrange, High Alarm, Low Alarm, Open Wire	Underrange, Overrange, High Alarm, Low Alarm, Open Wire
Operating Voltage	18-56 VDC	93-132 VAC / 105-145 VDC
Dimensions (W x H x D)	8.83" (22.44cm) x 3.50" (8.89cm) x 3.94" (10.00cm)	8.83" (22.44cm) x 3.50" (8.89cm) x 3.94" (10.00cm)



Analog Output Modules

Genius Analog Output blocks provide 6 channels of current and voltage outputs with powerful diagnostics.

	IC660BBA025	IC660BBA105
Product Name	Genius Analog Output Block, Current-source, 6 Channels, 24/48 VDC Powered	Genius Analog Output Block, Current-source, 6 Channels, 115 VAC/125 VDC Powered
Lifecycle Status	Mature	Mature
Network Support	Genius Bus	Genius Bus
Output Range	4 mA to 20 mA 0 mA to 24 mA	4 mA to 20 mA 0 mA to 24 mA
Number of Points	6 Outputs	6 Outputs
Points Per Common	One group of 6	One group of 6
Operating Voltage	18-56 VDC	93-132 VAC / 105-145 VDC
Resolution	6 micro Amp	6 micro Amp
Update Rate	25mS	25mS
Accuracy	0.15% of full-scale reading	0.15% of full-scale reading
Dimensions (W x H x D)	8.83" (22.44cm) x 3.50" (8.89cm) x 3.94" (10.00cm)	8.83" (22.44cm) x 3.50" (8.89cm) x 3.94" (10.00cm)



Analog Mixed Modules

Genius Analog Mixed blocks provide 4 channels of inputs and 2 channels of outputs. The channels can be configured for current or voltage with powerful diagnostics.

	IC660BBA020	IC660BBA100	IC660BBA024	IC660BBA104
Product Name	Genius Analog I/O Block, Voltage/Current, 4 Inputs/ 2 Outputs, 24/48 VDC Powered	Genius Analog I/O Block, Voltage/Current, 4 Inputs/ 2 Outputs, 115 VAC Powered	Genius Analog I/O Block, Current-source, 4 Inputs/ 2 Outputs, 24/48 VDC Powered	Genius Analog I/O Block, Current-source, 4 Inputs/ 2 Outputs, 115 VAC/ 125 VDC Powered
Lifecycle Status	Mature	Mature	Mature	Mature
Network Support	Genius Bus	Genius Bus	Genius Bus	Genius Bus
Number of Points	4 In / 2 Out	4 In / 2 Out	4 In / 2 Out	4 In / 2 Out
Points Per Common	One group of 4 Inputs and one group of 2 Outputs	One group of 4 Inputs and one group of 2 Outputs	One group of 4 Inputs and one group of 2 Outputs	One group of 4 Inputs and one group of 2 Outputs
Input Range	0-10 VDC, 10 VDC, 5 VDC, 0-5 VDC, 4-20 mA (or 1-5 VDC)	0-10 VDC, 10 VDC, 5 VDC, 0-5 VDC, 4-20 mA (or 1-5 VDC)	4 mA to 20 mA	4 mA to 20 mA
Output Range	0-10 VDC, 10 VDC, 5 VDC, 0-5 VDC, 4-20 mA (or 1-5 VDC)	0-10 VDC, 10 VDC, 5 VDC, 0-5 VDC, 4-20 mA (or 1-5 VDC)	4 mA to 20 mA	4 mA to 20 mA
Operating Voltage	18-56 VDC	98-132 VAC	18-56 VDC	93-132 VAC / 105-145 VDC
Resolution	12 bit + sign	12 bit + sign	Input: 1 micro Amp Output: 6 micro Amp	Output: 6 mA
Update Rate	Once every 4mS	Once every 4mS	Input: 16.6mS to 400mS (user selectable) Output: 6mS to 8mS typical	Input: 16.6mS to 400mS (user selectable) Output: 6mS to 8mS typical
Accuracy	Typical: 0.2% of full scale; Maximum: 0.5% of full scale; within 50mV on the 10 volt range, 25mV on the 5 volt range, and 100 mA on the 4 to 20 mA range.	Typical: 0.2% of full scale; Maximum: 0.5% of full scale; within 50mV on the 10 volt range, 25mV on the 5 volt range, and 100 mA on the 4 to 20 mA range.	Input: 0.1% of full scale reading Output: 0.15% of full scale reading	Input: 0.1% of full scale reading Output: 0.15% of full scale reading
Input Filter Response	none, 8, 16, 32, 64, 128, 256, 512, 1024mS	none, 8, 16, 32, 64, 128, 256, 512, 1024mS	16.6mS to 400mS (user selectable)	16.6mS to 400mS (user selectable)
Diagnostics	Input: Underrange, Overrange, High Alarm, Low Alarm, Open Wire Output: Underrange, Overrange	Input: Underrange, Overrange, High Alarm, Low Alarm, Open Wire Output: Underrange, Overrange	Input: Underrange, Overrange, High Alarm, Low Alarm, Open Wire Output: Underrange, Overrange, Feedback error	Input: Underrange, Overrange, High Alarm, Low Alarm, Open Wire, Output: Underrange, Overrange, Feedback error
Dimensions (W x H x D)	8.83" (22.44cm) x 3.50" (8.89cm) x 3.94" (10.00cm)	8.83" (22.44cm) x 3.50" (8.89cm) x 3.94" (10.00cm)	8.83" (22.44cm) x 3.50" (8.89cm) x 3.94" (10.00cm)	8.83" (22.44cm) x 3.50" (8.89cm) x 3.94" (10.00cm)



RTD and Thermocouple Modules

Genius Temperature Sensor blocks support a wide range of temperature sensors. The blocks support powerful diagnostics.

	IC660BBA021	IC660BBA101	IC660BBA023	IC660BBA103
Product Name	Genius Analog Input Block, RTD, 6 Channel, 24/48 VDC Powered	Genius Analog Input Block, RTD, 6 Channel, 115 VAC/125 VDC Powered	Genius Analog Input Block, Thermocouple, 6 Channel, 24/48 VDC Powered	Genius Analog Input Block, Thermocouple, 6 Channel, 115 VAC/125 VDC Powered
Lifecycle Status	Mature	Mature	Mature	Mature
Network Support	Genius Bus	Genius Bus	Genius Bus	Genius Bus
Number of Points	6	6	6	6
Points Per Common	3 groups of 2	3 groups of 2	3 groups of 2	3 groups of 2
Input Range	2 and 3 wire Platinum (DIN 43760), Nickel (DIN 43760), Copper, Linear	2 and 3 wire Platinum (DIN 43760), Nickel (DIN 43760), Copper, Linear	J, K, T, E, B, R, S, and N (#14 AWG Nicrosil vs. Nisil) thermocouples	J, K, T, E, B, R, S, and N (#14 AWG Nicrosil vs. Nisil) thermocouples
Operating Voltage	18-56 VDC	93-132 VAC / 105-145 VDC	18-56 VDC	93-132 VAC / 105-145 VDC
Resolution	0.1°C	0.1°C	Less than 0mV error typ., 20mV max.	Less than 0mV error typ., 20mV max.
Update Rate	Once every 400 ms, 800 ms, or 1600 ms	Once every 400 ms, 800 ms, or 1600 ms	2.0 sec (typ.), 3.0 sec (max.)	2.0 sec (typ.), 3.0 sec (max.)
Accuracy	At 25°C - Platinum or Nickel: 0.5°C typical, 1.0°C maximum 10W Copper: 5°C typical, 10°C maximum	At 25°C - Platinum or Nickel: 0.5°C typical, 1.0°C maximum 10W Copper: 5°C typical, 10°C maximum	8 Hz at 25°C	8 Hz at 25°C
Diagnostics	Input shorted, Internal fault, Wiring error, Open wire, Overrange, Underrange, High Alarm, Low Alarm	Input shorted, Internal fault, Wiring error, Open wire, Overrange, Underrange, High Alarm, Low Alarm	Open Wire, Overrange, Underrange, High Alarm, Low Alarm, Internal Fault	Open Wire, Overrange, Underrange, High Alarm, Low Alarm, Internal Fault
Dimensions (W x H x D)	8.83" (22.44cm) x 3.50" (8.89cm) x 3.94" (10.00cm)	8.83" (22.44cm) x 3.50" (8.89cm) x 3.94" (10.00cm)	8.83" (22.44cm) x 3.50" (8.89cm) x 3.94" (10.00cm)	8.83" (22.44cm) x 3.50" (8.89cm) x 3.94" (10.00cm)



High Speed Counter

The Genius I/O High-speed Counter block is a self-contained, configurable I/O module which provides direct processing of rapid pulse signals up to 200kHz.

IC660BBD120

Product Name	Genius High Speed Counter Block
Lifecycle Status	Mature
Network Support	Genius Bus
Input Range	5 VDC to 30 VDC
Count Rate	high-frequency filter selected 200 kHz maximum low-frequency filter selected 40 Hz maximum
Output Range	4.75 VDC to 5.25 VDC
Number of Points	4 Type A or 2 Type B or 1 Type C (12 inputs and 4 outputs)
Input and Output Response Time - ON/OFF (msec.)	high-frequency filter selected 2.5mS minimum low-frequency filter selected 12.5mS minimum
Input Filter Response	High (2.5mS) or low (12.5mS) frequency
Input Impedance	4.0K ohms
Accuracy	0.50% reading + 0.50% full scale
Load Current Per Point	200 mA
Operating Voltage	93-132 VAC / 10-30 VDC
Diagnostics	Outputs: Pulse Test, Failed Switch
Dimensions (W x H x D)	8.83" (22.44cm) x 3.50" (8.89cm) x 3.94" (10.00cm)



PowerTRAC Monitoring Module

The Genius PowerTRAC block is used in many types of power monitoring and industrial applications. The PowerTRAC block monitors current and voltage inputs and stores digitized waveform values for each input. From these values, the block calculates RMS voltage, current, active power, reactive power, KWH, and power factor. The block automatically sends this calculated data to a host PLC or computer approximately twice per second. The same data can be displayed on a Genius Hand-held Monitor, either locally or from any connection point on the bus.

A PowerTRAC block can be used with a wye- or delta-configured three-phase power system or with a single-phase power system. It accepts voltage inputs from one to three potential transformers, and current inputs from up to three line current transformers, plus a neutral current transformer.

IC660BPM100

Product Name	Genius I/O PowerTrac Monitoring Block, Accurately measures RMS voltage, current, power, VARs, power factor, watt-hours, and line frequency, even with distorted waveforms. 115 VAC/125 VDC Powered
Lifecycle Status	Mature
Network Support	Genius Bus
Input Range	0 to 120 VAC RMS at 47 to 63 Hz
Number of Points	(1) Three Phase Voltage phase A to B Voltage phase B to C Voltage phase C to A Voltage phase A to N (for line-to-neutral potential transformers only) Voltage phase B to N (for line-to-neutral potential transformers only) Voltage phase C to N (for line-to-neutral potential transformers only) Current phase A Current phase B Current phase C Auxiliary CT current Active power phase A Active power phase B Active power phase C Reactive power phase A Reactive power phase B Reactive power phase C Total power factor Total watt-hours/KWH/MWH Fundamental VARS phase A Fundamental VARS phase B Fundamental VARS phase C Fundamental Power Factor Harmonic VARS as % of Volt-Amps phase A Harmonic VARS as % of Volt-Amps phase B Harmonic VARS as % of Volt-Amps phase C Total Harmonic VARS as % of Volt-Amps Line Frequency Temperature Alarm Extended Watt-hours (high) Extended Watt-hours (low)
Calculated Data	
Accuracy	0.25% reading +0.25% full scale
Operating Voltage	115 VAC/230 VAC (90–265 VAC), 47–63Hz or 125 VDC (100–150 VDC), 35 VA max.
Dimensions (W x H x D)	11.00" (27.94cm) x 5.21" (13.23cm) x 8.06" (20.47)

Accessories and Cables

Part Number	Description	Lifecycle Status
IC660BSM021	Genius Bus Switching Module, 24/48 VDC	Mature
IC660BSM120	Genius Bus Switching Module, 115 VAC/125 VDC	Mature
IC660BLC001	Genius bus Cable w/Connectors Alpha 9823 15 In (Qty 3)	Mature
IC660BLC003	Genius bus Cable w/Connectors Alpha 9823 3 Ft	Mature
IC660BLM506	Bus Terminator 150 Ohm (Qty 4)	Mature
IC660BLM508	Bus Terminator 75 Ohm (Qty 4)	Mature
IC660BLM507	Genius Block Puller	Mature

Hand Held Monitor

Part Number	Description	Lifecycle Status
IC660HHM501	Hand-Held Monitor can be used to configure and trouble shoot Genius blocks. Kit includes Cable and Battery Charger	Mature
IC660BCM501	Hand-Held Monitor Battery Charger	Mature
IC660BPM500	Hand-Held Monitor Battery Pack	Mature

Configuration Guidelines

When configuring a Genius network the following guidelines should be considered

1. Genius LAN is limited to 32 devices. Remember that the Genius Bus Controller reserves one address and if a Hand-Held configurator is used, it also reserves an address.
2. If the application requires redundant networks, a Bus Switching Module is required (IC660BSMxxx).
3. Termination is required at the end of each network (IC660BLM50x)
4. For long distances, beyond 4,500 feet, the number of devices is limited to 16.

Cable Selection

Cable # & Make	Outer Diameter	Terminating Resistor* -10% to +20% 1/2 Watt	Number of Conductors/ AWG	Dielectric Voltage Rating	Ambient Temp Rating	Maximum Length Cable Run, feet/meters at baudrate			
						153.6s	153.6e	76.8	38.4*
(A)9823 (B)9182 (C)4596 (M)M39240	.350 in 8.89mm	150 ohms	2/#22	30V	60°C	2000ft 606m	3500ft 1061m	4500ft 1364m	7500ft 2283m
(B)89182	.322in 8.18mm	150 ohms	2/#22	150V	200°C	2000ft 606m	3500ft 1061m	4500ft 1364m	7500ft 2283m
(B)9841 (M)M3993	.270in 6.86mm	*120 ohms	2/#24	30V	80°C	1000ft 303m	1500ft 455m	2500ft 758m	3500ft 1061m
(A)9818C (B)9207 (M)M4270	.330in 8.38mm	100 ohms	2/#20	300V	80°C	1500ft 455m	2500ft 758m	3500ft 1061m	6000ft 1818m
(A)9109 (B)89207 (C)4798 (M)M44270	.282in 7.16mm	100 ohms	2/#20	150V	200°C	1500ft 455m	2500ft 758m	3500ft 1061m	6000ft 1818m
(A)9818D (B)9815	.330in 8.38mm	100 ohms	2/#20			1500ft 455m	2500ft 758m	3500ft 1061m	6000ft 1818m
(A)9818 (B)9855 (M)M4230	.315in 8.00mm	100 ohms	4 (two pair) #22	150V	60°C	1200ft 364m	1700ft 516m	3000ft 909m	4500ft 1364m
(A)9110 (B)89696 (B)89855 (M)M64230	.274in 6.96mm	100 ohms	4 (two pair) #22	150V	200°C	1200ft 364m	1700ft 516m	3000ft 909m	4500ft 1364m
(A)9814C (B)9463 (M)M4154	0.243 6.17mm	75 ohms	2/#20	150V	60°C	800ft 242m	1500ft 455m	2500ft 758m	3500ft 1061m
(A)5902C (B)9302 (M)M17002	.244in 6.20mm	75 ohms	4 (two pair) #22	300V	80°C	200ft 60m	500ft 152m	1200ft 333m	2500ft 758m

Notes: A=Alpha, B=Belden, C=Consolidated, M=Manhattan, * = Limited to 16 taps at 38.4 Kbaud

Examples of Typical Application

Configuration for Controller (Example application requiring (120) 24 VDC inputs and (80) Relay outputs AC power supply) for local control. System also has five remote cabinets, with each cabinet requiring (64) 24 VDC Inputs, (21) 24 VDC 0.5 Amp, Source Outputs and (2) current inputs and (2) current outputs (24 VDC power source). Maximum distance from control cabinet to the last remote cabinet is 3,500 feet.

Control Cabinet

Backplane Slots Required	Power Supply Current Required (mA)	Qty	Part Number	Description
2	1250 mA @ 3.3 VDC; 1000 mA @ 5 VDC	1	IC695CPU310	CPU with two built-in serial ports
2		1	IC695PSA040	120/240 VAC, 125 VDC Power Supply, current available 9 Amps @ 3.3 VDC; 6 Amps @ 5 VDC; 1.6 Amps @ 24 VDC maximum
	600 mA @ 3.3 VDC; 240 mA @ 5 VDC	1	IC695CHS016	16 Slot Universal Base
4	1200 mA @ 5V	4	IC694MDL660	Discrete Input Module, 24 VDC Positive Logic, 32 points (Requires terminal block)
5	35 mA @ 5V; 110 mA @ 24 VDC Relay	5	IC694MDL940	Discrete Output Module, Relay 2.0 A per point Form A, 16 points (Terminal block included).
		4	IC694TBB032	Terminal Block, Box Style
1	300 mA @ 5 VDC	1	IC694BEM331	Genius Bus Controller (GBC), supports up to 32 devices on a Genius Bus to control remote I/O, Global Data and Datagrams
		1	BC646MPP001	Logic Developer - PLC Professional
14	Total current from power supply required: 2775 mA @ 5V; 1850 @ 3.3V; 110 mA @ 24 VDC Relay. Only one power supplied needed.			

Remote Cabinets (Qty 5)

		15	IC660BBD024	Block 12/24 VDC Source I/O 32 Circuits
		5	IC660BBA020	Block 24/48 VDC Analog 4 Inputs / 2 Outputs
		1	IC660BLM506	Bus Terminator 150 Ohm (Qty 4)

Options to consider

		1	IC660HHM501	Hand-Held Monitor can be used to configure and troubleshoot Genius blocks. Kit includes Cable and Battery Charger
		5	IC660BLM507	Genius Block Puller
	840 mA @ 3.3 VDC; 614 mA @ 5 VDC	1	IC695ETM001	RX3i Ethernet module 10/100 Mbits 2 RJ45 connections one IP address occupies one slot on system base
		6	IC690PWR024	24 VDC, 5 Amp Output Power and 120/230 VAC Input Power Power Supply
		1	IC693ACC302	RX3i Long term battery for CPU
		1	IC754VSI06STD	QuickPanel View Intermediate 6 inch STN Touch Operator Interface

